



**Leaves**

**of**

**DAN**



[bethashem.org](http://bethashem.org)

## p r e f a c e

**The Leaves of Dan** appear upon your Trees of Names as *Your Ascensions of Judgement*. The terms, leaves, is rendered from the Ancien Hebreu,  $\times\Upsilon\zeta\textcirc$  *oylut*, meaning ascensions as leaves give rise to what is in a Seed. The Name, Dan, is commonly rendered as JUDGE.

Following the ascent.coming.emergence of the Mashiyach/Messiah amongst the nations, there is the coming of DAN—the Judge. When the Son of Man—the formulations of your SeedName comes with the unified glories of the Fathers, composed of all the angels/messengers within your Name, then shall you sit down upon your throne of glory as a Righteous Judge. “For the Son of Man comes in His Father's glory with His angels, and to repay/retribution each one according to what they have done.” The implications of the coming of the Judge includes your Name rising upon your throne: for when the Son of Man sits on His glorious throne, you who are followers—as the 12 Heads within your Name, having pursued and received of the Anointing, will also sit on your twelve thrones, judging the twelve tribes/branches of the Trees of YishARAL/Israel.

The contents in these leave/pages pertain to the Teraysarun Pyramid of Consciousness rising from the House of DæuW/David/ΔΔ in your SEED to come to your throne whereby in mastery of your Name you discern between the chaff of mortality and the fruit of immortality, between the goats on your left side, which are ever leading your steps, and the sheep on the right which have followed the teachings of Understanding, thus causing them to appear and be full.

**Progressions of Names are from the origins of DAN unto BaarShevoo/Beersheba**

(Sepher Melekim/1 Kings 4:25).

*From attaining to judgements of Dan in your Name—to discern your Origins— you enter into the Seven Wells, those being your Seven Eyes, full of the Wisdom, Understanding, and Knowledge of YæHúwaH.*





# The House of Dan— Wisdom's Judgment Hall in the Kingdom of Yish ARAL

Chamesh HhaPekudim / The Book of Numbers Chapter 26 Vs 42

These/The Divine Order of the Lights אלה  
are **the unified generation/offspring of Dan** יד דנ  
for their families—for the expressions of Wisdom, אהרן  
**for Shucham**, אהרן

families of the Shuchami. אהרן אהרן

These are the Divine Order of the families of Dan יד אהרן אלה  
for their families—for expressions of Wisdom אהרן

Vs 43

The complete families of the Shuchami אהרן אהרן אהרן  
are according to their summations/numbers/valuations: אהרן אהרן  
four—inquiry coupled with sixty—just weights and balances אהרן אהרן אהרן  
according to ALphæh/Principles, אהרן  
coupled with four hundred—insights/revelations אהרן אהרן אהרן  
within a collective residence.

**The Leaves of Dan** are unfoldings of the House of Dan. The works of DAN are inscribed in the SCROLLS OF CHAMESH HHAPEKUDIM/BEMIDBAR/THE BOOK OF NUMBERS, AND THE SEPHÚWR YETSIAT METSRYIM/SHEMOT/EXODUS. Dan is the Head of your Twelve Chambers which your spirit unifies together for a residence. Your Spirit of Judgement makes itself a Light-Body by its Numbers and then anoints them to attain mastery and transference. The Light Body of your Spirit is called the House of DAN which contains the patterns and thoughts in your Seed-Name (SYM/Ex 31:6). By making your bodies, you draw out of your Seed Twelve chambers in accordance with the Seven Breaths/Eyes of ALhhim.

Your Spirit is the Breath in your Lives—paths of ascensions. Breaths enter into dwelling states as they are appointed by Judgments of ALhhim—Shayin-Semek. The lungs and breathing apparatus of the body are called by the Name as the branch/tribe of Dan. Meaning “to judge,” the Name of Dan functions in the lungs, which hangs as a scale of judgment, to weigh your thoughts as well as to continually renew the rooms which your Breath occupies. As you are weighed on the scales of Libra, Dan sees both sides of an issue with equanimity and administers justice between your sides. Via the Spirit/Breath within a body, the body parts are animated according to the desires of their master. Your Spirit is the source of the body as well as the master to which your parts are subjected.

**Dan bears one offspring amongst the collective Names of the Seventy** (CHP/Num 26:42-43). The offspring are the fruit through which the glory of your Name continues. The State of a Spirit is based

### Introduction

There is nothing more evident to Life than the Spirit by which you live, move, and have being. What is in your Spirit is evident in what appears. Thoughts and states of a Spirit change whereby you set no boundaries as to what you are becoming. Based on what is in your Spirit the halls of science are built to explore the vastness which pulsates/breathes in all living and their surroundings.

Your spirit is founded upon the Words of the Seven Eyes of ALhchim, whereby your House of Dan has Seven Eyes. The words of your spirit are calculations of what are called “good trees” and “associate trees” of Knowledge. Words of people rise from the spirits of a people. According to the words of a people societies are built and maintained.

The words are spun as garments. A gown of yesterday hangs in a museum; however, when you put on the garments of your body, your fabriques are animated by your Breath which upholds them. **The Study of Dan is the exploration of what is in your Breath. As words and their dwelling states are of Breath, your spirit and its house are transparent.** In all that your spirit makes you come to know all within you. Afterall, in that the Spirit makes the ears, you can therefore hear the Voice of the Spirit; and in that the Spirit has a Voice, you can speak things of the Spirit. You are not estranged from Spirit lest you deny your own Breath of Being! You come to know all things by your Spirit. The study of Spirit in the LEAVES OF DAN takes priority over external forms made by Spirit, for you are inquiring into the Nature of Spirit and how it makes its dwelling places. In these LEAVES you will examine the nature of Spirit and its Words. According to Spirit you have understanding to what is read and interpreted whereby there is nothing estranged to you. In that Words are inherent in Spirit, those things written are discerned by Spirit. However, should you seek to know the world and that which is within your bodies without the Knowledge of Spirit, you remain over-shadowed in wondering and have yet to come to the Light of the Spirit—the very Light of your Name. Whether one learns via mathematics, literature, a science or through metaphysical thoughts, the source of computations and their meanings are in Spirit. From Spirit, the disciples of a Name appear and come to the Schools of Light.

A Spirit becomes manifested by subjecting itself into seven wells of water as one who enters into the

upon its offspring or generations. According to the Nature of **Shucham**/non-partiality, the offspring of Dan, your Spirit enters into its states of residence/Zebúwlan of Seven Eyes.

**The Values of Seventy** make full the Consciousness of Understanding as your Spirit breathes to activate the Numbers within your Eyes. The study of the Seventy Names of immortality—which pass beyond the world—opens the mind of Spirit to see beyond unto its destinies. The Seventy Names comprise the Collective Consciousness of Bayinah within the flames of Spirit. **Shucham**, of The House of Dan, is one, thus the unifier, of the Seventy Names—meaning to be **without partiality or weight**. Through Shucham you acquire discernment to enter and live peaceable in a **Collective State**. You are born as a result of unions of the Eyes of ALhchim. The consciousness within your Spirit requires a collective state to be born and to fulfill its purpose in the Collective. The Consciousness of the Collective and its Laws—constructs of Thoughts—are the fabrique within every Spirit.

**The Lights of Aharúwan enable you to distinguish between the Fathers and the world.** Through Illuminations of Aharúwan you are not bound to the world to seek after pleasures or things which are passing. You live above the world by the love of the Light in you. By the love of the Fathers you are devoted to support and reciprocity. Your pleasures are operating in your Rings of ALhchim. Your “games/performances” of mind are exercising the Words and Works of Lights which involve the mind and body in concert.

**By forming a body, a spirit enters into a house for an embodiment.** You designate your powers to serve the Fathers of Light from which your Spirit comes. Your choices and execution gives evidence to the consciousness in your Spirit. Service to the body is being yet sleeping. When one serves the Lights of Aharúwan, from which they come, they are awake. You can distinguish to

womb of its mother. Whether it be the ocean, or a river, or the waters inside the uterus, each spirit enters into a body to make a journey. The waters of your mother are from the state/inheritance of the mother. As a Spirit enters into the waters of mortality, it enters into a strange or foreign land for the Spirit is immortal. As the parable of maShayh/Moses, you enter into waters of Metsryim/Egypt to appear in your generation. Within the waters a Spirit composes its body with ashes—distillations of thoughts acquired from the offerings of its Numbers—calculations, meditations, and deeds.

From the Fire of a Spirit comes water and air. As a consuming fire, the Spirit gives of itself through which it forms the waters—distillations of steam by the Words of its mouth. From the thoughts of Spirit, there forms pools of waters and air. The cooling of the ashes, waters, and gases forms earth—a hosts of Light. The earth formations are residues/residences of what your Spirit has given. Upon these ashes, your Spirit walks. In rising above foreign soil, you put under your foot the ashes of opposition [Malachi 4:3]. Opposition? How is the body of ashes in opposition to the Spirit that formed it? Everything requires training. A Spirit subjects itself to the waters of a strange land in order to bring unto subjection that which it enters. By making a body, the thoughts of Spirit are tested within a state to bring them unto subjection of your Name to whom they belong. All things created by Spirit are designated to bear the glory of its Name. **Everything made is brought unto subjection to the one who makes it unless the one who makes a house remains subject to that which it has made.** A Spirit learns to master that which it enters through using its Numbers to arrange its houses and their states of manifestation. Each embodiment is a testing of the organization.

Evident within your Spirit are Twelve parts which forms a house or body. These Twelve are brought into alignment with each other that they convey the Unity of the Spirit which births them. Through designation of the Twelve in the body, the outer organization becomes one with the inner organization. The process of this unity is the mastery of a Spirit, whereby that which is within the Spirit is proven to be unified by the extension of itself into a vessel. The outer arrangement becomes one with the inner organization. **A Spirit tames itself as a Master of all that is within it.**

At death of a body, a Spirit rises from the ashes that it has made, and walks upon them. From what is

walk in darkness or in Light. The process of entering into a body and rising from it is the theme of many parables conveyed in the stories of maShayh/Moses and Yahushúo. When we take apart from the Collective, we enter into strange lands. As maShayh/Moses, you are born in Metsryim/Egypt from which “you are called out” as you approach the Lights. You are strangers in the world, knowingly or unknowingly. Out of Metsryim you are called to be the Offspring of the Fathers. You become subject to the state of your embodiment until you seek an Elder who guides you to behold the inner orders of your Life. Upon consultations with the Elders you behold the inner members as a burning bush whose Fire does not go out. You follow the Voice in the midst of the Fire/Spirit. As you hear the Voice, you call forth the 12 within you to do likewise to follow the Shepherd as sheep. This is depicted in parables to assemble the 12 tribes or to call the 12 disciples. The harmony of the 12 correspond to processes of unifying your inner parts into the Collective Kingdom. *e.g.* When RAúwaben is mentioned in a parable, the story concerns the eyes—how your eyes are seeing and what the eyes are doing. Similarly, when there is a story about Shamoúnn/Simeon, the parable is disclosing information regarding the roles of hearing.

You enter into the world to give of yourself, whereby your Spirit comes to know itself. The ability to give all that you have to the poor is to be as the most humble servants as the Fathers—owning nothing. Your giving all demonstrates you are as the Fathers of Light who seek no worship nor attention above another. **Upon your learnings within an embodiment, you demonstrate the extent of your giving.** Upon fulfilling your assignments, you return unto the Fathers in peace—with the full expressions of joy to enter into immortality. As you give freely and hold on to nothing mortal/corruptible, you bear the mind of immortals who live above the world in their Light Body of Aharúwan. You know and affirm that you own nothing individually. Yet all things are yours to

learned in the days of its sojourning a Spirit goes forward with the skills of subjecting itself unto the Laws of its mouths. The ability to regulate yourself within an embodiment of foreign matter affirms the immortality of a Spirit to rise above all states of mortality, those akin and those yet to be understood. **As a Spirit affirms the origins of its Life and masters all that is within it, a Spirit enters into Immortal Life.** According to the Laws of Life within your Spirit you become a Master of your house [Yahushúo/Josh 24:15; Gal 3:24].

Through forming a house, a Spirit animates itself into chambers by extending its Light. One does not create to possess; rather, one creates to gain empirical knowledge of the Thoughts of Light evident by giving all within Spirit. Should a Spirit withhold that which it is, it does not come to know itself entirely. The weavings, as woven strands of Light within a Spirit, are drawn out to reveal its thoughts of ALhhim. As a worm draws out silk to form its dwelling, a Spirit draws out of its resources, strands of Light to appear, and then enters into them whereby they are known [SMB/Gen 4:1]. One weaves a garment of Light of the threads given of AL—strands of the unified Faces of Yæhh. As you have freely received, you freely give thereby demonstrating that you are of the Collective Lights which holds all things common.

The Spirit of Dan rises from the lands of its sojourn, whereby the ashes do not dim the Light they contain. One walks above corruptible forms made for a season to affirm its incorruption. From immersions in the waters of ALhhim you make progressions from one level to another of schooling. You pass through seas, springs, and rivers to enter the mountains of the Fathers. You bear your glories within all Lights of the Universe (suns, planets, moons, stars) according to the magnitude of Light drawn out of your inner chambers, thereby demonstrating your immortality.

A Spirit affirms itself through the Words of its mouths. By speaking and writing the Thoughts of Spirit, texts are formed. The Túwrah/Torah is composed of two laws. There are the Laws of Spirit which are spoken and the Laws of Letters which are written. Both Laws are one Law. The Laws of Spirit are the utterances of Light—strands of Thoughts which are woven into parables as Teachings of the Unified Consciousness. The parables are composed with information which make them transferable to every student and age [Yimeyahu/Jer 31:33]. They are not written as historical stories of a single person or people, nor do they refer to fixed places of the world, as they exceed locations and times that a spirit passes through. The Laws of the Letters are written within the

share collectively as one house. As Light works, you give unto the expansion your Names as the Fathers [The Poor], without partiality. You are of the Light by the works of your hands. Through your givings, you form the Head of 15 full moons of YæHH which radiates their Thoughts within 30 Faces. The 15 full moons are formed as two parts/sides of Light ride through the skies, appearing sequentially, **in the Name of Yæhh** אַל [10+5]—*the full giving of Light*. The two sides of Light are the Name, YahYah אַל אַל. The full moons of ShmúwAL, on days 30, are paired to the dark moons of ShmúwAL on days 15. What is full gives completely through 15 days/Faces of YæHH, whereby we know there are 15 Faces in Yæhh. Day 1, being nearly full is joined to day 16. The sliver of light given on day 1 shows up on the corresponding side of day 16. The two parts of the moon within a span of 15 paired days create 15 full moons. These are called **the 15 pairs/faces of YæHH**.

The two sides of your House of DAN are two sides of your Seed-Name formed in the two moons of Maneshayh —in the testes/ovaries. Out of the Seed sac rises the Semek פ skeleton upon which you hang your members as daily offerings of your Name. As that which is in Maneshayh rises, the 15 Faces of the Fathers fill the faces of a Name whereby the 14 facial bones bear the 14 Name of Maneshayh. The 30 days of Light are called by the Names of the 15 Fathers set in courses of 12 months through which their Faces are seen your 12 houses. By imparting your Light daily, according to your 30 Numbers of Name, you extend your Light. You ride upon the heights of the earth in concert with the Unified Heads and Faces of the Fathers who transverse in the skies gracing their children [Tehillah/Psalm 68:5; SMB/Gen 1:16].

Joy is your daily strength which abounds according to measures of your giving. Every gift of your Name annuls misery. The fruit of separating yourselves falls from your trees; as you freely give what is in your midst, The fruit of your Name remains. As your Spirit gives of itself, you are as the Names of the

body that the Spirit makes. The Laws of Letters are inscriptions to regulate manifestations unto Hhúwa—the Illuminated Breath who makes them (Tehillah/Ps 148:5). When the words of the Heads of the Body are the Words of your Spirit, there is one Voice which speaks whereby the written words ring with the messages of the spoken words. **The Voice able to carry what is spoken and written is the Voice of Dan which rises as the Judge of all things, Invisible and Visible, unto the peace of all Spirits as one.**

The LEAVES OF DAN reach into the Wells of Life and draw out aspects of the Kuwáhnim/priests from which are the Faces of the Fathers and the Eyes of ALhhim. **You affirm through this documentation the nature and details of your Spirit to be unified and congruent Rings of Breath with your Source.** Through your inquisitions, you activate your Words and States of Spirit into consciousness and sustain them where ever you go/proceed. With Knowledge, Understanding, and Wisdom you set your Faces according to the Spirit to know the patterns of Light spiraling in the universe to build a House unto the Collective Name, YHWH, in whom you are called. You set your manifestation (flesh) to follow thereafter as a master of that which is within you. With these objectives you affirm your Breath and its appointed places which are set forth to be studied within these Leaves.

of dwelling unto another is in conjunction with decisions made in the courtrooms of Dan. In the House of Dan are stalactites—ice crystals descending as northern thoughts. The stalactites convey thoughts of Wisdom coming down from the north. The stalactites in the caves of Dan are hidden enclosure of jewels. The cave is the cavity of the chest where the lungs and the trachea hang. On the chest are two teats, one for mercy on the right, and one for discernment/judgment on the left. As you touch the teats, you release a flow of life, with discernment and grace, streaming from your foundations in Maneshayh. All aspects of your Light are released sequentially from your SeedName as you demonstrate the ability to care for them with implementations. Measures of thoughts flow from your sacs to be incorporated into the Light-Body of ARiAL.

In **the House of Dan**, descending thoughts are compiled in your members as **bars of gold**. These, in part, make-up the treasuries of Yahúwah [Bayit Dibre HhaYamim/II Chr 5:1; 12:9]. A bar of gold is inscribed with Oovri Paleo Letters of HhaALhhim—engraved by Light. According to the Bars of Gold, decisions are made in the Judge's chambers. The number of bars total 434, which are a reductive value of 11/Υ, the Trees/Teachings of Lives, paired 1:1. Principles of Wisdom, ALphæh to Yeúwd, lead you to the Kephúw/11—the *Tree of Lives* in which the Seed 4 is extended ρ. The 434 bars pertain to the sum/Taúweh/Χ/400 within the Order/Lammæd/30 of the Teraysarun/Dallath/4. As you ascertain messages of Wisdom in the golden bars, you are prepared with the treasuries to enter a silver door in the House of Dan. Through the silver door of DAN you enter into a chamber of judgment. The room has a silver floor, silver walls and a silver ceiling. This is **the judgment hall of Shucham/equality**. To the right side of this chamber there is another silver door. This door leads

Fathers [The Poor], without partiality/Shucham.

Your 12 camps of YishARAL correspond to the parts of your organs. Within this assembly of 12 your Spirit dwells. The 12 members depict a collective city of Lights. **The House of Dan corresponds to the respiratory system and the trachea.** The trachea/wind-pipe is the pole of a coiled serpent.

The lungs attached to the trachea are the wings whereby the serpent soars. The lungs also convey scales of judgment. The primary meaning of **Dan is to judge/evaluate to determine just weights and balances.** Via Dan you regulate vision, engage in inquiry and evaluations, and initiate the running of thoughts within the sides of the Mishkan—the Tabernacle.

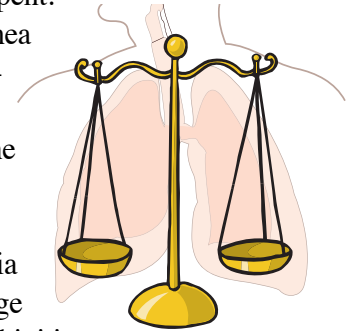

Dan occupies the respiratory system—a Branch of Mind which provides renewal for all parts to continue within their lands. You reside according to decisions made in the camp of Dan. The moves from one level

you into the room of witnesses. As RAúwaben/Reuben is at the side of Dan, the witnesses are at the side of the Judge. There are 8 seats for the witnesses, one for each of the eight Names of RAúwaben [Chamesh HhaPekudim/Numbers 26:5-11]. The witness room has a gold floor, silver walls, and a bronze ceiling. The witnesses confer about every issue to consider the foundation of the matter, the sides—the construct and the extent of the matter, and the fruit—the expressions and results of a matter. ***They grant life or death to every issue/thought/process. There is no in-between decision; there is life; or there is death which is pronounced by the judge of Dan.***

The meShich—attainment of full stature comes by Dan—with judgment [Metiayæhu 25:31-46]. The full measurement of HhaALhhim is the character of HhameShich. In that the Judge/Dan comes upon the end of the ages, indicates that Dan is before the worlds are made—what is last is first. Through acquiring full embodiment of HhaALhhim you are able to judge the matter and status of your Name.

#### The Sheep and the Goats

The separation of the sheep and the goats occurs at the time of the harvest. One gathers the new flock that has been raised and curtails or trims the form in which the Twelve grew. The parable depicts the fruit of the meek ones—the sheep that have been embodied within a unified house/body of the goats. The fruit is gathered at the harvest whereby there is an increase/blessing. The shell which gathers the Light is disposed of/cursed. One does not retain the former habitations as they are not able to contain the expansion of the Numbers. *A new body is required for new wine.* The shell is the body of unity, ÚWah, depicting the goats. The twelve inward parts or sheep reside within the shell. The Light of the Fathers that has been gathered during the growing periods is retained, and that which is of the world is cast away. From every appearance 4Y9 or coming, there is the separation of the sheep from the goats or the Bayit/the Sheep from what was gathered amongst the goats/ÚWah. The proclamation of the sheep and the goats span from the 7 hills of the Aúvim. The blessings on the sheep are uttered on Mount Gerizim—the far right mount, and the curse of the goats—regulations upon one's state are pronounced by the Voice of the Judge upon Mount Oyval/Ebal—the far left hill.

Via the discernment of Dan we determine our progressions. Where are we proceeding? Where are we to enter into for our next encampment? Will we continue in our present level of manifestation or shift our collective consciousness unto another frequency to reside? ***Our next occupancy is based upon the House of Dan which determines our abode. With the discernment of Dan we have direction into the Lands of Light. We observe how the Staff within us is turning and the direction that the Hand is leading.*** As Dan is the Head of the northern camps, the Judge leads the way in making decisions, affirmations, and meditations unto future calculations. Dan is the Head of Ayshshur/Asher and Nephethli meaning that the lungs are the head of the stomach, which is known as the Body of Dan, and also the heart, which is known as the Life of Dan. Within our heart we meditate night and day upon the Laws of YæHúwaH.

Aparryim/Ephraim is the head of western camps and corresponds to the reproductive center. Aparryim is the member that leads our tribes into their dwelling states; however, ***it is the House of Dan that initiates direction of our progressive movements into States of Light.*** Since Dan dwells in the north—in the reflective side of the Mishkan/Tabernacle—Dan stirs the pot of thoughts which keeps us thinking and creating. The camp of Dan is the depository to receive distillations of thoughts



as their vapors chill. The distillation of thoughts occurs in the north creating ice crystals. These projectiles form structures of thought and prisms of light. When they melt they are fulfilled by our fiery Breath. From the distillation of thoughts rises judgements to detect and to determine matters. According to the distillation of thoughts and deeds, we answer questions, make decisions, and solve mysteries.

Dan forms an apparatus for respiration, for all avenues of Breath. The House of Dan and our Breath occupy the same house. When the Judge comes, the Spirit of a Name that has prepared itself with Wisdom is joined to the Judge. This marriage is portrayed in the writings of the union of the meShich and the bride. The operations of judgment and the Presence of Breath in the Twelve form a marriage which does not dissolve. This is the marriage of two becoming one. Our Fiery Breath alone can unite/marry to become One. The Túwrahh pertains to the position of our Fiery Breath. Should we read the Túwrahh as speaking of fleshly objects, then the words of the Túwrahh would fall apart as an object subject to decay. In that the Words of the Túwrahh are of Fire; they are incorruptible and thereby abide eternal to speak in any generation regarding the State in which our Breath resides.

#### THE UNION OF BREATH AND THE MATRIX OF THE SHAYH

When the Túwrahh states that a man/*Ayish* takes/accepts a woman/*Ashayh*, it is referring to the Breath of Fire/*Ayish* learning of its inward Nature of Light/the Numbers of *Ashayh*. Both terms, *Ayish*/WṚ 4/32/5/Ṛ and *Ashayh*/ṚW 4/27/9/Θ, are words of *Ayish*/Fire/W 4/22/4/Δ. *Ashayh* corresponds to the inhaling activity of Breath in the House of Dan. The ALphæh/Ṛ in *Ashayh*/ṚW 4 is a prefix to the word Shayh/ṚW. The Letter ALphæh corresponds also to a heifer that provides a house for the ALphæh Principles. The matrix of the ALphæh is within the ALphæh even as ChauWah is within Adim [Eve in Adam]. Likewise, our bodies of Light are within our Seed Names. The matrix of the ALphæh is comprised of the Cardinal Numbers of the left side of ALphæh in which are the measurements of .5/Ṛ or hatzee, meaning a half. [see The Cardinals of ALphæh to Yeúwd—The Head of the Yeúwd chart within the Amuwri section of this document]. The Light Principles of the right side of ALphæh—called the ALhchim of Lights/.5/Ṛ are joined to the left side measurement of .5/Ṛ,—called the Tsavaut/Hosts of Light. The union of the two sides forms a perfect Seed/Word of Reshun/550. From each composite WordName one draws out the Bayit/House/Ṛ of YæHúwaH. This perfect construct of thought is the Hhúwa-Úwah-Hhúwa/ṚYṚ or the Union of the Lights through which a House is made.



The intertwined serpents illustrate the Union of two Names unified for their health/wholeness.

From the base of ALphæh, Principles are fully extended and arise unto the Head of the Yeúwd. In joining the base of Hhúwa-Úwah-Hhúwa/ṚYṚ to the Head of the Yeúwd/Ṛ, the Name of YæHúwaH/ṚYṚṚ appears. *According to the Union of Light Principles—the Hhúwa-Úwah-Hhúwa/ṚYṚ, every word in the Oovri/Hebrew language has two sides after the pattern of the menu-rahh.* Each Word is comprised of a central stem that branches to the left and the right. According to the two sides of Light come forth the glory of the Consortiums/Kingdoms of the North and the South under the administrations of the two kings of Aparryim and Yahúdah. **The central letter in each word is the central idea that appears amongst the letters at the two sides. The central stem holds the sides together as one thought.** The House of Lauwi is the central stem in the midst of YishARAL. Via the two sides of the south and the north, the Mishkan/House of Lauwi is built. All Names are sent from

the heart of YæHúwaH and are called out from their state in the world to build a Mishkan—a Tent of Meeting with tapestries of their thoughts, whereby they create dwelling states/worlds without end for the Thoughts of the Most High to dwell with them.

According to the founding concept within every thought appearance there are the clean and the unclean. The clean are the 7 pairs in the Tevah, and the 1 pair of unclean is the body of transition. The 7 clean pairs depict the Seven Rings of ALhhim/Elohim which assemble together in a house [SMB/Gen 7:2]. The clean are the thoughts of Light in which the Hhúwa-Úwah-Hhúwa—the sides of Light are united as one. Unclean thoughts are as an outward shell which holds the thoughts, enable them make transitions into other states. This shell is toppled and overthrown for it does not yet know the Union of Light honored within it. Via the clean stones of ALphæh, concepts and thoughts coming from the unclean are continually cast down and torn asunder, for they are not of the same frequency as the Unity of Light within them. Hereby the flesh or outward nature is not able to withstand the winds and the fire that test them, nor the stones that crushes the chaff amidst a millstone of two sides.

The seven pairs of clean vessels/animals [states of animation] are the Seven Eyes of ALhhim. The Seven Eyes form a body for the glory of a Name to be housed. The seven pairs of ALhhim form the House of Life/Tevah/ark in which a Name resides. The glories of a Name are housed in a transitional body until the formulations of the glory of a Name are fully come whereby there are no limitations or boundaries imposed upon the Name during its developments. The provisions of one unclean pair conveys the processes of change through which one emerges through bearing the glories of ALhhim unto their immortality of Light.

The Lights of a Name are housed in the offspring of Dan—within the spirit of the W ꞑ Shayin-Semek ALhhim of a Name. As the Lights of a Name are designated into the I 4 Rings of their SeedName, one bears the Faces of their Lights. The Faces are the W Glory of the ꞑ 15 Fathers which abide in all spirits. As a Spirit enters into the Waters of the ALhhim, they are put on the Body of ALhhim. The 7 Rings of a Name clothe the spirit with the glories of ALhhim, whereby their garments nor their shoes wear old.

The Spirit of a Name enters into the Rings of ALhhim as the Mind of the Spirit is activated according to their Seed Logo. From the activations of the Logo—the composite Words of a Name—one commences to engage in branching their thoughts. What is within the inner parts of their Seed is brought forth as an *oylah*—an ascending

*offering*. The offerings are likened to the leaves upon the sprouting branches of a tree, whereby they are called, leaves/*oylut*, for through them comes the growth of a tree and also its coverings. The *oylah* offering is made according to one's Collectiveness. Through the *oylah* of a Name one brings forth their faces—expressions of Light. The Faces of a Name are

CHP/Numbers 28:11

Through activations of the Heads רלW449Y 11  
 one renews seasonally the branches of their glories מררלWΔE  
 to bring forth from their inner parts רררל49X  
 to be an *oylah*—a mode of ascension רלC  
**for YahúWah**—belonging to their Collectiveness. רררררC  
 Their faces are offspring/generation ררר מררל47  
 of seeing through both sides of their Rings. מררלרW 499  
 With their inner strength ΔE4 רל4Y  
 they branch through a study/year/season ררW רלרר מררW9Y  
 to become seven/*complete*, רO9W  
 without blemish—a perfect resemblance. :רררררX

formed by uniting the two sides of each of the 7 Rings of ALhhim within a SeedName. The faces create an avenue for the inner strength to emerge from the SeedName through stages of developments whereby one becomes a perfect display of their Seven Rings.

In the Túwrahh, the sequence of the offerings are presented to begin and fulfill every work [CHP/Numbers 28:11]. The process of activating the 12 Heads within your Seed are formulas for the RashimChadashim/Heads of the Months. When one is referred to as “sleeping” their life is yet in a shell, yet to open. Though they are walking about, they are responding to the world—the external states verses bearing the Faces of the Light from within their SeedName. They carry the weight of the world on their shoulders, and thus imitate what they see verses causing the Light within them to structure the worlds around them to be lamps for their Light. Through the ten plagues/strikes of the Light, the shell of the Name opens to release their 12 Heads [SYM/Ex 12:37-38]. The parable of the 12 tribes coming out of the world conveys the breaking forth of the 12 Heads from within every SeedName. The Heads emerge as offspring of ALhhim to branch forth their glories within their 7 Rings. As each of the Heads are fully expressed within the Body of ALhhim, one enters into their immortality. The ascent of a Name that bears their Light within the Rings of their Spirit is called the meShich or the coming of the Messiah, meaning that the full measurement of their Life has become manifested.

As you bring forth the Rings of ALhhim you form a Tree of Lives. Your body is a House to carry and reveal the impartial Thoughts of your Name. Uniting the associated members in the Seed is the means to create the Rings of ALhhim. As the Rings are formed in a SeedName, you manifest a spirit of impartiality within yourself and between others. The impartial fruit of Shucham of a Spirit is a prerequisite for the Light of a Name to appear, for by the spirit of impartiality the Rings of a Seed are formed. By forming Rings of ALhhim all parts of a Name mutually abide as one vessel which bears the Light of their Seed. Hence, for the Light in a Seed to rise, a house is first created to bear its glory. From the formations of the House of Dan, the Life of a Spirit rises like a tree planted by the waters of Maneshayh/Manesseh.

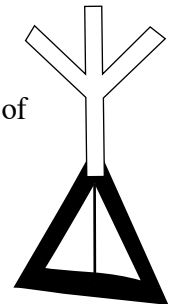

The emergence of the stalk of a Seed is called the coming of *the Branch*. **The Branch**, from the writing of the Tanach, pertains to **the Branch within every Name**. The messages of the prophets Yeshoyahu/Isaiah, Yirmeyahu/Jeremiah, and Zekkaryahu/Zachariah refer to coming ruler as **the Branch** [Zech 6:12]. From these writings stories are composed of one *of Nazareth—one who branches*. The Branch comes from David—the double teraysarun  $\Delta\Delta$  that forms the Seed of a Name. The Branch  $\Upsilon$  emerges as the Seed opens to give of itself. The double  $\Delta\Delta$  is the Name of Daúwd/David. As the stalk comes forth from the midst of the double Dallath, one builds a Temple/dwelling state of Daúwd. Upon the formation of this House, one rules over their members and processes with the counsel of peace. As one completes the branching of their Seed, a cap stone appears upon the crowning stalk. Prior to the cap stone formation, which is the head of the seed stone, everything in a seed must rise to the head, even as all within a seed must rise to the top of the plant to form the fruit of the harvest. The ascent of the capstone is from the heart of Nephethli which rises on the Branch of a WordName. The stories of the Branch come from the ALhhim of Dallath-Dallath and Kephúw-Kephúw. The Word,  $4\text{9}\Delta$ , denotes the offspring  $4\text{9}$  within the beloved branch  $\Delta$  of ALhhim. Hence, the Offspring of ALhhim are called, The Word/Logo, for each Name embodies the Collective Thoughts of ALhhim which are composed into a SeedName upon their altars.

Through the three levels depicted in the three kinds of oylut offerings, one gives of their Wisdom, Understanding, and Knowledge which has been woven as Light strands in their Seed. As Dan makes the offering upon the wood/arrangement of the Rings of the Eyes—those of the RAúwaben, a spirit transfers their three measures of wealth in their Name from their Spirit into their houses whereby their houses become full of all good things. The glories of Wisdom are set into the ALhhim Rings of a Name through the *parim offerings*. The glories of Understanding are activated into the ALhhim Rings of a Name through the *ayil offering*. And the glories of Knowledge are set into the ALhhim Rings of a Name via the *offerings of the kevashim*. As one multiplies their Seed, they make a harvest of grain for the manchain offerings. As the teachings of the grain are fulfilled, one bears upon their branches the fruit from which the full joy of the wine/nesek offering flows. The setting forth of all faces within a Seed upon the altar is *a fire offering*, for it comes from the fiery spirit of a Name.

One of ALhhim discerns that “it is not good for HhaAdim/Adam to dwell alone” —for the Vapors/Adim to be without the embodiment for their full expressions of joy. Every SeedLogo is provided a house through which the characteristics of their Light are unfolded into a fabric of society. As the cardinal ALphæh Principles of a Name rise into action—unto the Yeúwdim/Deeds of the Hands, one beholds within their Seed *a woman*. The ascending ALphæh Cardinals reveal the inner constructs of two lights/sides of Lights. The two sides of a Ring depict the Queens of Wisdom and Understanding. Each half,  $.5/\aleph$  is a side of Light. The two halves  $.5/\aleph + 5/\aleph$  form 10—Yeúwd—the hand, through which the Seed ALphæh extends. The Yeúwdim/Hands are the works of comprised of 5 fingers of each hand. As a result of extending the Light within the Seed one draws from their side the woman through whom the offspring of the Queens are born. Until the Queens appear, the 70 Offspring of YishARAL are within the SeedName awaiting their emergence [CHP/Num 26]. The bearing of woman—*lit. the house of the Seed* gives testimony to the union of sides within a Name to create a vessel to bear its Light. As Principles of ALhhim rise from the Seed, they convey the collective order to which a Name belongs. Through Dan, one becomes aware to make a habitation for their Words—to construct a Mishkan—a tabernacle for their Name of Light to reside. The state of residence of a Spirit conveys the awareness of the Light within one’s seed and the activities of their hands. One builds the mishkan by the ascent of Oholiab of the House of Dan within their SeedName. [Sepher Yetsiat Metsryim/Ex 35:34].

As the Adim level of consciousness sleeps, it dreams. Through dreams one draws out of the north side of a Name. In the dreams of the Adim, configurations of thought from a Bayit/House and the lands into which the Name resides. That which is drawn out from the north becomes united to the Head Principle of the SeedName as a body becomes united at the neck. What forms coming out of a sleep are according to the thoughts drawn out. The sleep referred is induced through composing one’s parts upon the altar and coming to rest in YæHúwaH [SMB/Gen 15:12; 2:21]. The Bayit or House is joined to the Thoughts which belong to the Breath of the One of ALhhim. As the

## LIGHT

The Unified Concepts of the 15 Fathers bound into Words generate Light. As quick as an idea, Light flickers and causes movement. The Light in a Word is drawn out into thought streams and clustered into rings which houses them. In that the Word is of Light, the Word remains and does not change.

**Light is devoted to all forms of Life and their habitations without partiality. Light bonds are Word agreements whereby thoughts and their forms abide together as one.** Together Words and their Rings share the joy and consolation of mutually belonging one to another. The bonds sustain each other to fulfill concepts. By the bonds the thoughts are extended within the mind to form renewing states of Consciousness. Via Light there are ascensions of ideas and their spiral weavings [Cushi] which form a state through which the concepts appear and become

sleeper awakens, the thoughts assembled in the dream emerge. As a result, one of Dan/discernment leaves father and mother to enter into the House of ALhhim. With Dan, the discerning Name takes the Shayh אַװ on the tenth day of Aviv to receive the matrix to construct a habitation of Light—immortality. The formulations of the shayh create the BayitHhaSham—BetHaShem. Leaving father and mother and the houses and lands of this world is portrayed as departing from Metsryim/Egypt. In this regards Yahushúo says, “Verily I say to you, there is no one who has left house or wife or brothers or parents or children for the sake of the kingdom of ALhhim, who does not receive a hundred fold at this time and in the age to come eternal life [Yúwspah/Luke 18:29-30].” The hundred fold is the *manchaih/grain offering of complete Knowledge*—the ten ten’s [for further information see BHM notes: Chamesh haPekudim/Numbers 28:13].

The dream of Avrehhem, wherein the offerings are halved and the pieces laid out, is a sequel to the dream of Adim. In the dream of Avrehhem the cardinals of the Yeúwd, the Oyin/Ayin, and the Shayin are laid out. The Yeúwd/א on the right and the Shayin/W on left combine to form the Oyin/O in the midst. Together the Letters form the word WOא, meaning the Oyin Kingdom. WOא corresponds to the word אַװO meaning to finish and to make unalterable; to create a state of perfection that cannot be undone or ever revoked. Such a creation is of the incorruptible giving of the Spirit of Life. What is of the Oyin Kingdom, being of the Authority and the Union of the Light, is indivisible. The smoke passes in the midst of the pieces whereby the Mind of Avrehhem ascends and is positioned to bring forth the habitation for Yetschaq, namely the Ten/Yeúwd Lands [Sepher Maoshah Bereshith/Gen 15:7-21]! The three offering types: the heifer, the goat, and the ram do not pertain to years but correspond to the three levels of Light. Wisdom is conveyed by the heifer; Knowledge—the goat, and Understanding—the ram. Avrehhem takes/learns of the Mind of YæHúwaH from each of these three classifications of thought and distinguishes one’s parts into two sides whereby one knows the extent of the Mind of YæHúwaH from the base to the crown. The setting of the parts into 2 sides forms bonds of Unity in the Branch of a Name, from which creates the Staff of Lammæd. In arranging the parts of Lammæd, Avrehhem receives the 10 Lands which each Name is given as an inheritance upon forming the solidarity of their branches. The 10 Lands appear at the side of Lammæd/ל as the Yeúwd/א/10 extends from the sides of the Staff or as hands/deeds extend from the Teachings. The lands are called the body of the Oyin-Zayin [commonly the Land of OZ] through which the works of a Name are fulfilled, even as the fruit of a tree appear upon the stalks coming from its sides.

Via inhaling/accepting, a **Spirit draws-in information of Light unto the heart** to compose fiery thoughts within us. We are part of the

expressed. By Light—Unified Concepts of the Fathers bound into Words—there is a continuance of Life unto what is called, “worlds without end”. The elevations of thoughts in a Word creates mountains and their valleys in which a Name dwells.

Gad [House of Speech] as the Head of Nephethi [House of the Heart] sets the mind and the members to speak utterances according to the Fires of the Fathers. With consciousness we set our mouths to the Fires of the Altar of the heart unto the fulfillment of our Names. Through our Words we bear the full expressions of the Light of Eternal Ages. **The entire scope of our lives is viewed in the administration of our Words.** As the Words of our Name are spoken we walk in the Light therein and do not stumble. According to our Words so is our State of Being.

Darkness is a house of Light which gives the Light distinction. Light אַװ is movement of thought within clusters of harmonic principles. When a concept forms a sustaining thought, there is Light—an energy created by unified sides which abides within the sides. In Light is the intelligence to compose itself a body from the sides. The body emerges from the darkness—the layers of Light. Everything is made by Light. The Thoughts of Light or Essence of Light is in what is made even though there appears to be no light present; i.e. like in the bottom of the ocean or in a seed. The seed appears dark like the depths of the ocean; yet these locations are retaining the essence of Light in them whereby they can respond to Light. Darkness, as well as all bodies are made of light. When one has layers of various colors of Light compounded, the layers appear as darkness. Light movement within defined sides form clusters. These clusters are harmonic ideas which

whole by accepting another. No one rejects everything, for unless one eats, drinks, and inhales there is isolation unto death. The term ashayh/אשׁיח, meaning woman, which is of the א Seed of Shayh/אשׁיח. The shayh is accepted/taken on the 10th day of Yahúdah via which one goes out of one house unto another house [SYM/Ex 12:1-3]. Both *ashayh* and *shayh* unfold the matrix via which we compose the houses for our Names and their progressions. For each of our houses—our tribal camps of thoughts—we take the shayh/אשׁיח—**the Crown of our Lives**—whereby we weave thoughts emanating from the sides of Queens into a new body. The exhale of Breath is as warm radiance of the sun; the inhaling of Breath is as beams of the moon that cools us in the night. **Within the Breath and the Heads of the Shayh are the thoughts to compose the unleavened bread of the Faces for each tribe.** With the matrix of the Shayh we are enabled to move to subsequent progressions and into the House of YæHúwaH. As we weave the thoughts of the Shayh we enter into the Kingdom of the Queens, the same being the Lands of the Oyin-Zayin Body. Entering into the Oyin Lands is the State of Immortality, for one enters into that which is in the midst of the Garden, the Tree of Lives. As the 70 Names of the final generation of YishARAL are read within us [ChameshHhaPekudim/Numb 26], the Shayh provides the matrix—the interwoven patterns within our Name Logo [Sepher Maoshah BeRashshith/Gen 32:7,8,13] to create a house for the seventy Names within our Seed. Within the matrix of the Shayh the seventy Names are cast. As we follow the shayh we move from one state unto another unto our perfection of becoming.

The Shayh/Lamb of Yetschaq/Isaac is an oylah/burnt offering of the Wisdom of Avrehhem whereby a foundation is laid for a new generation. The Pessech/Passover shayh offerings [lamb/goat] are roasted in Fire, for only via the Fire we receive/partake of the matrix patterns [SYM/Ex 12:9]. Likewise, the pattern of the House of YæHúwaH that maShayh/Moses reads in the mount are the Words of Fire. Thus only via Breath can we partake—engage in the study of the Lamb upon our lips to bring the pattern within us. Thereby we need the entire shayh for the Pessech offering whereby every compartment of thought is obtained and whereby all of the 12 tribal houses rise into the House of Freedom upheld by the bones of Yúwsphah. The shayh is depicted in the parables of the Essenes as the coming meshich/messiah to convey *the ascent of the Branch* in every Name. We must draw out of our Seed the Core Logo of the Lights of our Fathers and follow after the teachings therein to enter into the Kingdom of ALhhim, willing to forsake all else for the States of Light.

The projection of thought—exhaling and the gatherings of thought—inhaling are processes of knowing and meditation. The fiery Breath of Dan bonds and seals unto itself the houses of a Name via the activity of

come together to form body parts in the midst of the sides. The clusters are harmonic groups of Words whereby they reside together in one body. The inherent harmonic principles are the Light. When the body gives of itself as an offering, then it reveals its Light. The Light comes out of the darkness like the sun rising in the morning or as the Life rising from inside a seed.

**Light is cohesive energy** which forms mathematical and molecular chemical formulas. Everything made by the Light contains the Light אשׁיח, whereby what is made is capable of being transformed as the Words of Light are opened and extended. The darkness—layers of Light—forms spaces or residences for the Light. As we look into the darkness of the sky or the dark body of a tree we behold houses of Light. When the formulas of Light commence to give of themselves, they multiply whereby the Light in them is seen. The formulas of Light are transposed from side to side through which the Thoughts of Light appear [SMB/Gen 2:18-23].

The one of Light distinguishes itself from darkness whereby there are no self-imposed limitations or boundaries in which one resides. Through honoring the Fathers within a body one enters into ascensions. The emergence of Light from a Seed composes further bodies in which the formulas are compounded. A body is a display of Light extending itself through subsequent creations. Therefore one keeps the body always in subjection/support of the Light which formed it, for the body is the servant of the Light. Should the members honor the Lights of the Fathers within them, they are elevated as the Light emerges within them. As the members give unto the Lights of the Fathers there are no restrictions upon one's life nor the joy of the Faces within. When the formulas of

exhaling/*ayish* and inhaling/*ashayh*. In this manner, what is projected from *ayish* is accepted/learned/taken unto itself/*ashayh*. *Ashayh* is then of the same bone/structure of thought and flesh/expression of thought as the *Ayish*—*Fire emanations of Adim*. **Unions in the Túwrah are the joining the Letters to the Numbers which comprise a united strand of Words in the Mind of YæHúwaH.** The Letters/Words/Houses are joined to the Values/Numbers/ Principles. The Numbered Words multiply within A NAME whereby each house is filled with the Breath which projects and carries forth the Numbers and Words of YæHúwaH. **As one breathes and speaks the Numbered Words, they become a life-giving Ruæch unto all of their members, which is the basis of immortality** [I Corinthians 15:45; Yahuchannan/Jn 6:63].

The first Adim/Adam [sets of Rings of ALhhim within a Seed] become a living soul/Wᵓᵓ/52/7/I — *a perfect expression/faces of Ayish* [man/the exhale of Breath] and *Ashayh* [woman/the inhaling of Spirit], unto becoming a life-giving Rúæch/Spirit/ᵓᵓ4/34/7/I — *one of perfect speech capable of regenerating and bearing offspring of one's Spirit*. The complete extension of a Name is 70 (7 x 10) unto forming the OyinMind/40 — *of complete Knowing*. The transition from a soul to a life-giving spirit fulfills the statement that two are one/unified. There is no separation/partiality between the Rings of a Spirit whereby a Name is able to bear immortal offspring. Out of every union comes the perfect. When we separate, we see in part. When the perfect appears there is nothing hidden, and one attains seventy fold—the Oyin of Rayish. All thoughts are drawn out of YæHúwaH by two—through unified sides. The Adim/ᵓᵓ4/18/9/⊕ know Chaúwah/Eve/ᵓᵓ4/19/10/4—the Principles of 9 know they are One in Reshun 10/1. The two/ᵓ are summed up in collective Name of Adim/18/9/⊕. The Tæyth/⊕ is formed by joining two Bayit/ᵓ at the corners or by making two right angles of 90°. As the two comprising Adim are swallowed up into one, the Tæyth/⊕ is dissolved into the Oyin/O. The emerging Rúæch/ᵓᵓ4/214/34 comes out of the soul of 7/I Rings. As the 7/I come into consciousness, Intellect of Spirit/Rúæch joins Oyin/O to form the IO, the life-giving serpent. [See the Illustration following regarding the STATES OF RESIDENCE pertaining to Serpent.] Soul contains the Life of the Spirit within it as every expression or fruit contains a life giving seed. The inner Life in all of soul is Bayinah. As you draw out the life within soul, you become a life-giving intelligence, for now you are able to emit the Life within soul. A Life-Giver projects Life via their Breath, even as their Name is projected from the Mouth of YæHúwaH. Essentially, *the Life-Giving Rúæch is the progression of soul that has drawn out all of its Life in unity with YæHúwaH. The Name, YæHúwaH, from whence a Name is projected is fully expressed through the offspring whereby the offspring gives life also.* The speech of a Life-Giver comes from a tongue of Fire which imparts life to every Name within their members/branches/ house-

a Name in the teraysarun ΔΔ Ring impart their Numbers of residence unto the ᵓᵓ Ring, a house expands [i.e. the offerings of Nephethi upon Shamounn]. The 15 inherent Principles of Light create formulas of Numbers which are arranged according to the ideas. These formulas create a body for its head to appear. The Values of Light 4ᵓ4 Aúwer are the same as the Numbers of the 15 Fathers of Yæhh ᵓᵓ. 4ᵓ4 6 : ᵓᵓ 15/6 bear the 12 houses of a Name.

We bodies of Light, i.e. the moon and the sun, are lamps for the Light. The Light of the 15 Fathers are strands of thoughts which cannot be seen. No man has seen The Light as a form. The Light is within the rays of the sun and the beams of the moon, yet the Light of the Fathers is the Logo of their Words through which the sun and the moon are made. The sun and the moon are bodies/wives of the Light. They carry the Light and show us how the Light moves and works. **The Logo Light is within the Name of every offspring, whereby one knows the Thoughts and the Deeds of the Fathers.** The sun, moon, stars, as well as everything that has Breath are clusters of the Thoughts of the Fathers. Every Name contains HhaDavar through which their parts hold together in a body. When the Logo of your Name breaks open then the Offspring of HhaAdim [The Adam] and its Light has come to reveal the Father within them. The Logo is the true Light within every Being. As the Words of the Fathers go forth, so do the Lights run within the meridians of the heavens/the mind and the earth/the body.

holds whereby all becomes immortal by the Words spoken from the tongue of the fiery-serpent [Yahuchanan/Jn 5:21]. These words are carried and imparted by those of the Unified Breath which abide in the Body of **Bayinah**.

The Breath is sent from The Principal/Father even as Breath is projected or exhaled via Ayish whereby it is forever attached as a conceptual thought strand. When our Names and Numbers are read in pairs, we are Breathed upon and exhaled from the mouth of YæHúwaH. Our Names are sent from the gates of Light emanations through a Trustee/Possessor of the Names—a Mother who will Nurture each offspring of thought. *The Principal and the Trustee are the Source of the evolution of thought* from which one is sent forth, as a seed sown, *to become whole as the Unity from which we are begotten and sent/sown*. In becoming whole, we are **one flesh—a Unified Thought** whereby Yæhh/The Principal/Father and Wah/the Trustee of the Lights/Mother are expanded. As a unified Thought, a Name is woven into the Fabric of the House of YæHúwaH. Through the construction of united paired Names, as **living stones—solidified thoughts**, the Bayit HhaSham/House of The Name is built. Each name of the Principal has a Trustee/Possessor of its Lights. There are two Names within each strand of Thought—a Principal or First Name and its Trustee. Each Name is a Trustee of the other. Yæhh sustains unity with Wah, and Wah sustains unity with Yæhh through their perpetual bonds of Unity; thus the two, Yæhh and Wah are One Name—YæHúwaH. In this understanding a spirit has a first or primary Name. The concept of middle names pertain to all of the Names within our midst. A last name is the family and tribal name from which we are extended. We are drawn out from the tail or the last name. Out of the last name of our tribal collective our first name comes forth. The drawn out Names are woven together and designated by the Mouths of YæHúwaH. The united Names operate within the Kingdom of Light as positioned by YæHúwaH for the sake of the whole and for the joyous expressions/faces of YæHúwaH.

#### DAN: ONE BREATH

**In coming to the Unity of Thought** we become whole. We return unto our Primal Mother/Intellect of Light in which we are perfect. A whole Thought *discerns its Construct of Words and the Number Values* that comprise it. Based upon our calculations and implementations, we are either righteous or unrighteous. The righteous are those aligned with the Union of Breath, having been joined/united with the Unified Consciousness. The unrighteous are those outside the Union, seeking their own ways and interests, whereby they dwell separate from the organizations and intentions of Light. By faith or understanding in the eyes and heart of Avrehhem one is called to be righteous/upright/aligned in the Collective Body of Names. As the SeedPrinciple expands in the Name of Avrehhem, that which comes forth forms a pillar in the midst of society. As a servant of the Union one looks unto the habitation/dwelling/mishkan of the Union and does not surrender their Name to anything contrary to the Union of Spirit. As one understand their foundations in Chækúwmah, one is justified—aligned with the River of Thought coming out of the throne of Wisdom. The prophet Yeshoyahu speaks the Mind of YæHúwaH: “Keep Me in mind in judging to be One; Number yourself in order to be righteous” [Yeshoyahu/Is 43:26]. We **recall** our point of origin to which we affirm the core of YæHúwaH in our Name, even as Yahushúo affirms the Principal Essence within consciousness and thereby declares, “the Principal/Father and I are One,” for both are emanations of Wisdom and therefore the same. *Recalling* is a function of Yashuv in the House of Yishshakkar—within Consciousness—that is cultivated by the offerings.



In affirming the unity of our Name we are consumed into the collective assembly of Names to function as paired/woven Names as we are placed within the Union of Breath. Every Name has a counterpart; the two Names together carry the pattern of YæHúwaH/26/8. As first names come out of last names, so Yæhh comes out of Wah even as all things come out of Chækúwmah/Wisdom/אמץא. We may read the Name Chækúwmah as the Living/א Tree of Lives/א and the Conductor/א of Light/א. Since Wah is the last Name, the first Name, Yæhh, comes out of Wah/אא/11. Wah is a Tree/א/11 of Life, and in Their midst—Yæhh/15/+úא/6/Wah/11 are all Names of Life/26/8. Wah/אא, as the Trustee/א of the Breaths/א, emanates the Illumination within Her, whereby the Name Yæhh/אא emerges. Yæhh/אא/15/6 is the Offspring of the Union by which all things are unified/א/6 which comes forth from the Trustee—the Intellect. As the Offspring, Yæhh is therefore called the Principal, being the emanations of the 15 Fathers from which a Name is extended. Since all Names come from Yæhh as the Collective Emanator, the embodiment or Trustee is within us—every house is within its seed of emergence whereby Chauwah is taken from Adim. The ancient question, which is first, the egg or the hen, the answer is the Hen. Every egg has within itself the Hen from which it comes forth. Thus when we construct our bodies within our mothers, we draw out the patterns from within them through which we appear as One of the Faces of YæHúwaH. We weave the patterns of our origins around our Names which are circles of thought. According to the development of the thoughts in our mind in the day of our appearing, so is our body prepared to house our thoughts. The exterior form is a reflective illusion of your mind. While this body perishes, only the Thought of your Name is real and has Eternal Life. A thought does not die; however, projections fade away unless they are constructs of perfect—complete thoughts arising from the four-square foundation/א which are clean without corruption.

Cháuwah took to eat by perception, not a form of the fruit itself. If one eats from the Teachings of the Collective and the Associative Thoughts of Churav/Horeb, they live and do not die. Every tree in the Garden is said to be eaten including the Tree of Knowledge. However, when one looks at the fruit on the tree, essentially the deed of the teaching, and thinks that it means something different than what is taught, they eat to their own demise. *e.g.* Cháuwah looked upon the fruit. What is seen as it is perceived is eaten, whereby the actual fruit of the ALhchim was not eaten. When one looks at a commandment and perceives it different from the intended meanings then one partakes of their perceptions, whereby *they eat apart from the Fruit of the ALhchim*. When the Seed of the Fathers is not present in the deed/fruit there is no life; and hence, death. Thus when one eats from teachings in which the Seed of Yæhh is not present, they eat unto death. The parable conveys that when one eats of their own illusive vision and not of the Teaching itself one dies—does not continue to ascend into the Mind of meShich. Should one eat from the Tree of Knowledge of the Collective Good and the Associative Thoughts they live, for in this fruit is the Seed of Life of the Fathers. The fruit of the righteous is a Tree of Lives.

The Lands are of States of the Fathers which are bound into your Seed-Name as the body of plant is drawn out from the midst of the seed. As the patterns of Zebúwlan are laid upon the altar, the house of Beniyman—what is hidden in a Seed-Name rises as twelve states/cities of Light, which appear from the core of the Fire/Shemmesh. As the Lands are seen from within your Name you enter into them as your inheritance from the Fathers.

The 7 eyes of ALhhim are made into one body as they are joined from AL to AR, whereby there are 7 Rings of the Fathers suspended as one. The Fathers have been asleep in the world, within the Seed-Names of their children since the worlds are made. Generations continue after generations (2 Kayphah 3:4). The Seed of the Fathers are the weavings of their congruent Thoughts of Light into the Seeds of their generations. By the Seed all things are made by Light. The weavings are woven into a Seed, the Seed is sown, and the worlds are made. What is formed is called the offspring or fruit of the Fathers, whereby The Seed is called the meshich—the measurements of Life which are anointed to rise by the Breath of the Fathers awakening within the Seed. In this sense the meShich is with the Fathers as the Bread that comes down from above. In the Seed are the Formulas of the 15 Fathers through whom the Faces of the Fathers are revealed in the Offspring/Children. Until the Seed of the Fathers rise from within the body of a Name, the Fathers remain asleep as the Seed of a new creation. Nothing is gathered or transformed from what is made until those who are asleep rise (I Thes 4:14). The turning the faces of the children to the Faces of Fathers within a Seed is the culmination of the Great Day of YæHúwaH and the fulfillment of one age unto another. At the culmination of the age the meShich comes or appears, for now the Faces in the Seed have blossomed in every Name/child unto a new generation.

As you discern the 70 circles of thought of your Name, you enter into the state of the Oyin Body, comprised of ten Letters, each with seven levels. The Oyin Body arises through the Tæyth/⊕ as a Union of Bayit/𐤁/Two Strands. In this manner the immortal dwelling arises from within the womb of Chækúwmah. As we come to abide in the Mother frequency of Light above, we draw out the immortal patterns of Light and abide within the 70 circles of Oyin. From the Head of Oyin the body of the flying serpent comes. Thus any contact with the Body of our United Name puts us into the Oyin Consciousness. As the streams of Consciousness come down, we cover the mortal with immortality. The body of our present dwelling contains the patterns of the former even though it is now humbled due to the presence of containing two sided thoughts or having a mind of Havel/Abel and the mind of Kayin/Cain in the same house. From whence do we enter into the Body of Oyin? It is formed by the union of strands of Clean Thoughts. When any two thought Names are united, they formulate the Bayit base of the Oyin Consciousness. From the tail of our existence we rise, even as maShayh/Moses takes hold of the tail of the serpent, and flings it upwards to become a staff. As the 70 circles of a Name wrap themselves around the inner pattern they lift themselves off of the ground as one having wings, whereby the serpent is transformed within us.

#### THE OFFSPRING/FRUIT OF DAN

The fruit/son of Dan is one: Shucham. The **unified Name of Shucham** leads us to enter into the garment of 70 circles stemming from the 70 Names of Knowledge. With the consciousness of equality we enter into the womb of Chækúwmah, for we are now One with Her. When we think that we are better than another we have fallen from the womb premature; and hence, we abide in deformed thoughts and are left to another until we come to judge the matter and the state that we are within. We change our identity of one people for another—from an Egyptian to a Hebrew. No deformed thought is acceptable upon our altars; it is an abomination to the Unified Consciousness of our Mind even as the lame and the blind and the deaf are not brought unto the altar as an acceptable offering to YæHúwaH. We look at our hands and our feet. We examine our deeds and our proceedings. Are we fulfilling the deeds and paths of Light? Are our hands and feet dedicated to the Union, or are they for

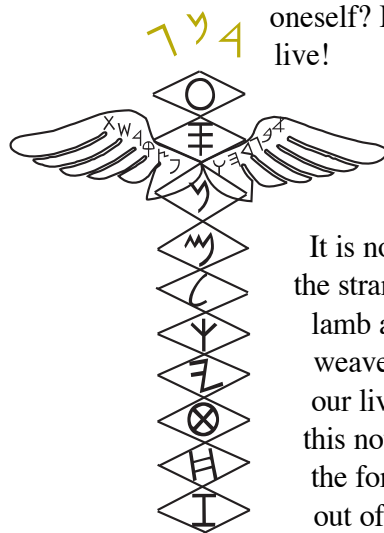

oneself? If the latter, they perish, for nothing is able to abide unto itself and live!

The garments of the Oyin are created from the leaves of our Tree Name which issues forth from the seed. We weave the strands in our Seed of Light to wrap ourselves. From the cotton seed comes the flower—the full extension of the seed—from which a garment is spun.

It is not from the mouth of the spider; rather, from the tail that we draw out the strands of Light at the Dallath DoorWay. There we draw out the *kevesh* lamb and the offerings of Fire each day from our tail/loins whereby we weave strands of Light in which we dwell and inhabit. Thus, the garments of our lives and the houses in which we live are in the Words of Knowledge. Is this not the purpose of our breaking out of Metsryim/Egypt? For as we leave the former we come to dwell in the midrashim/wildernesses—the drawing out of Words, which takes us into all categories of Knowledge. The seven

stages of the Wilderness, *MeDevarim* are stages of growth in which we draw out of Seeds of ALhhim to fashion the Lands of the Oyin Mind. The words, being compositions of the 22 Letters, comprise the value of 136/253/10/1, the One Body. In that the Words of YæHúwaH are of the 22 Letters, the sum of all Words of ALhhim are Achadd/One. As we arise out of Metsryim/Egypt, we take out of them [our embodiment/definitions] the gold and the silver. With the gold and silver of Metsryim we fashion ourselves a new dwelling state [SYM/Ex12:35].

The Tanak Scriptures oare composed of 22 scrolls, one writing for each of the 22 Letters of the Oovri/Hebrew Tongue. Within the writings are many parables to assist us to see the consequences of our choices. The Túwrahh/Torah is a compilation of affirmative actions for those who seek to walk in Liberty. The Essenes wrote further parables of the emergence of Consciousness, commonly called The Gospels. The stories of Yahushúo/Jesus convey the coming and the ascent of Consciousness within every person. The Essene writings are composed to interpret the meanings in the Túwrahh as they break forth within every person. The coming of Christ in the text refers to the Origins of every person. The Consciousness within every Name appears or comes into the world whereby all are saved from the vanity of the world. The barriers to fulfilling the harmony between achim—the brotherhood in all peoples is the creation of religions which misinterpret the writings according to the outward nature of the world. *The projection of the writings in terms of the world leads to acts of incivility.* The Consciousness is like the sun: a golden bowl of Light filled with silver.

The body is the means to define oneself. As the eyes of a Seed are opened, the body appears. One beholds themselves. As a tree, the characteristics in the Seed are fully expressed in the body of its branches. We acquire the gold and silver from our embodiment in Metsryim through which we formulate our subsequent garment. The gold is the Wisdom, and the silver, the Understanding via which all things are created [Mishle/Prov 8]. As we depart from one level of residence in Metsryim, we appropriate the gold and silver that we have obtained unto our next dwelling state. With the gold and silver in our defined/apparent bodies we produce the copper and the dyes for the Mishkan/dwelling of Light. When we wear gold, we put on the garment of the pure essence of Chækúwmah; when we wear silver we are of her twin sister, Bayinah. When we wear copper we are of the fruit and the Faces of YæHúwaH from which comes all colors of fabrics, made from the flowers and plants of the Seed that are within the Queen.

Within the Bible is **the Story of Dan**. The House of Dan is one of 12 configurations of Light via which the Temple Body and its functions are made (SYM/Ex 31:6; 35:34; 38:23). AychiSemek upholds the Fathers and their Bones. The House of Dan is the Breath/Spirit of a person which appropriates the Numbers of Light into various chambers. The parts of the body that are made with gold and silver contain the Thoughts of Consciousness. These parts receive and transmit the Thoughts of the Fathers of Light whereby their Faces appear amongst us. The Mind of DAN is **impartiality** through which all mysteries are shared and understood, spirit to spirit. This thought of Spirit is conveyed in the generations of Dan, known as **Shucham**.

The Breath is capable of a perfect Union for it is impartial. The Breath of a Name is comprised of all Letters and Numbers that make up the three Teraysarunim/Pyramids of Wisdom, Understanding, and Knowledge. Literally, the Breath that blows from all four sides is **an alphanumeric formulation configured as four charts of Letters and Numbers**. These charts of the Letters and Numbers of the ALphæhBayit include the Cube of Wisdom in the west, the Cylinder of Understanding in the east, and the Rectangles of Knowledge in the south and north.

The Cube is the Foundational Six Sided Structure of Wisdom. Six sides depict the Unified Thoughts of Breath. As the Cube is extended into a Teraysarun/pyramid, aka the Dodecahedron, twelve sides become apparent. There are six inner and outer sides or six front and back sides to the Cube of Wisdom. As the sides arise from the base/foundation of Wisdom, the twelve sides become visible in the Teraysarun. From these united six sides in the Cube come the paired branches of the Tree of Lives, known as the twelve Houses of YishARAL. As the Cube branches and brings forth from within itself, the first formulation becomes the prototype of all Names. Hence, as we behold the six paired branches of our Breath and see them before our eyes in our assembly of twelve associated organs, we declare that we are of Wisdom and belong to none other than the One United House of Light—YæHúwaH! From the Base of Wisdom, comes the Rectangles of Knowledge comprised of the branches extending from the base. This ascension of branches is the pattern of the ascending Light within the Cube. The lamp of Wisdom, being of pure gold, and being two sided with six branches, is the Menurahh/Lamp stand within every mishkan/dwelling of Name.

Connecting the Cube and the Rectangles of the North and the South forms the Cylinder. The Cylinder is an elongation of the Cube that enables the Rectangle to be fully extended. The Cylinder is six sided as the cube with an inner core of three columns surrounded by three outer columns. In the Cube of Wisdom the six sides are two sided. In the Cylinder there is a top and a bottom ring from which comes the head and the body of all things. Arising from the Cube into the Cylinder is the pattern of the fiery flying serpent that is comprised of the Letters of the ALphæh Bayit. The body of the serpent is the ten inner letters in the midst of ALphæh to Taúwah, The body is comprised from the tail—Zayin, unto its head—Oyin, with wings coming from the six sides, right and left [Yeshoyahu/Isaiah 14:29]. The cylinder may appear as a circle or an oval or a column as it maintains the space between the Foundation and the extended branches. The Cylinder of Light is the House of the Laúwi/Levites that carry all things of Wisdom and enable Wisdom to become manifest. The Laúwi are also called the joiners for they connect all things from the Foundation to the Crown. Hence, they are forever the servants of the Temple of Wisdom and the priests of all Names. The Cube is known

as the Chamber of Wisdom/Chækúwmah. The Cylinder is known as the Chamber of Understanding/Bayinah via which all of Wisdom is surrounded and arises with expressions of The Assembler's Thoughts. Bayinah, which comes out from the Chamber of Chækúwmah, is in the very midst of Chækúwmah.

The 22 Letters of the ALphæhBayit are arranged in Cube, Rectangle or Cylinder formats. Within these structures of thought are the Numbers/Values of the Letters. The Numbers are invisible, yet by them all things appear! The Letters are the means to compose the garments of our habitations; the Numbers are the Values within the Letters. As one becomes swallowed up by the Breath, they harmonize the frequencies of their manifestation in accordance to the frequencies of the Breath, and thus they appear as the Invisibles. This is the stage of being transfigured, whereby the Logo of a Name projects its Light Nature through their body. Seeing that Breath is comprised of the Principal Letters and Numbers, it carries the vibrations of all messages of ALhhim.

From the nose to the lungs and diaphragm, the House of Dan formulates an invisible teraysarun comprised of Breath itself. A teraysarun is a twelve sided structure of Light. The House of Dan is a four sided pyramid each comprised of three pyramids making twelve sides. Hence, the initial Letter of the Name, Dan, is Dallath Δ. The teraysarun pyramid is a projection of the inner and outer walls of the six sided cube/honey comb as discussed above. The apex of the Teraysarun of Breath is the pyramid Δ nose. The House of Dan occupies the lungs as the first level of breath's occupancy. **The lungs are the judge's chambers** in which Dan resides to decide the fate of every thought and deed. The lungs hang upon the Tree of Lives as scales hang upon the pole to determine the outcome of all things. Thus, when we see an accident or something wonderful, our Breath processes the thought with a gasp.

Via the lungs, Breath processes the patterns of thought and actions of its members. As the Teraysarun expands, Breath occupies space from the nose to the diaphragm. Those who control not their appetite for things in the world, become overweight, and therefore retard the expansion of Breath. Shallow breathing occurs through the nose and in parts of the lungs, leaving the body mass to become flab/unshaped by the controlling Breath within. Our bodies are shaped by Breath as we enter into our mother's womb, and our habitation continues to be shaped and regulated by Breath.

When we came into the *wudah/veda*/world, the nature of the outer began to smother our aspirations of Rúæch, as Qayin/Cain smothers the brother, Hævel/Able. When the flesh dominates and distorts the form of our Name, it is due to the lack of extending the Breath into the lower areas of the body whereby one maintains proper form. Breathing deeply causes all members to ride upon the wind. Weight control and the expressions of a Name are regulated by discernment and Breath. Remember, our body is water, and therefore a reflection of our Breath vapor. From the distillations of our vapors/adim, we gather our bodies of water for a habitation. As the Fiery Breath exhales, so the vapor of our Breath gathers around us. As the waters are circulated around our Fire/inner core, the vapors/steam of the Breath are cooled and thereby gather as a liquid to hold your Thoughts and to mirror your Nature of Breath. With this awareness of how Fire creates holding tanks for its thoughts, we understand how every form comes from the Fiery Rúæch/Breath.

Everything is comprised of waters/distillations of Breaths. Water serves to expand and mirror the realities of Light Principles. The forms in the *wudah* are illusions because they are unstable and are continually being changed as transforming vapors. The waters are moved by the winds just as our BREATH is able to move our body mass and shape it.

***Breath is the basis for every expression.*** If one is angry, it is due to a rage of Dan carried by the inward Fiery Breath. If one is loving, it is due to the fondling and gentleness of Dan as expressed by the inward Fiery Breath. *Every expression is a Face of discernment.*

As the tree of your Name extends, there is an extension of Breath based on judgment of oneself. Breath extends from the crown to the base, creating the Tree of Lives. As our branches extend, they are filled with Breath, and hence the Rúæch HhaALhhim. We are filled with the RúæchHhaALhhim according to our extensions of tribes and the expansions of mind. One is filled with the fullness of RúæchHhaQudash [The Holy Spirit], as ***they expand their mind to accommodate and to house the fullness of ALhhim.*** Otherwise, they are yet developing the capacity to be filled with the fullness.

If you go throughout the universe, you are not further from YæHúwaH than where you are now, for the Breath of YæHúwaH fills the universe. Nor can one go to the top of a mountain, or by proximity become closer to YæHúwaH. Neither can one of your members hide from your Breath, for your Breath/Rúæch is all pervasive [Tehillah/Psalm 139:7-18]. The Higher Consciousness of your Name is your Breath which knows the impulses of your members, whether they are honoring the Breath or seeking to deviate from its Presence. Your Breath never slumbers or sleeps; it watches after all of your members both day and night. Your Breath is your most faithful guide and continually leads you in the expansion of your Name. As all of your members are joined as one, you are in tune with the Unity of your Breath and positioned for progressions. One of the greatest statements in the Túwrahh is a confession that all of our comrade/associative members are one. This is the confession that arises from the brothers of Yúwspah who stated, “We are all the sons/***unified extensions of one fire-man***” [Sepher Maoshah BeRashshith/Gen 42:11]. Let this statement be upon your Breath often as it solves many wars and heals misaligned internal and outward preferences of one member above another.

The Breath is the Vine; the tribes are the branches. In the parables, the Voice of Consciousness, Yahushúo, says, “I am the Vine, and you are the branches,” whereby one affirms that their branching is according to that which flows from their Consciousness. One speaks as of the *Anuki/I am Consciousness*. The Breath in us is the *Anuki/I am/YæHúwaH* that resides within us by Name. Our collectivity comprises the branches which go out from our Breath as branches run from the Vine. The visions of the Prophets [Yeshoyahu/Isaiah 11, Yirmeyahu/Jer 23:5-8 and Zekkaryahu/Zech 3:6-10] all speak of a Branch that arises from within the stem of Yishai/Jesse, a branching of spirit which guides all peoples to righteousness and peace. This Branch stems from within your camp of Yahúdah and rises to become your righteous Judge. Sense now the pricking of this Twig within! Look at the Branch breaking through [via Perez] the node of Yahúdah within you! This Branch is destined to arise within unto its full awareness! Cultivate the families of your Name to branch the oracles of the prophets. As the branch from the tribe of Yahúdah breaks through from within, your lands are filled with knowledge and peace. Via cultivation of one’s Numbers, we accumulate knowledge unto shallam. Through branching one is enabled to proceed in progressions of Túwrahh Thought as revelations are subsequentially given. One is readied in Mind through their branching to affirm and express their totality.

Moreover, look for this *sprout* growing within your neighbor and affirm the Branch amongst your comrades of Light, saying, **“This is the Branch the Seers have seen, and you are bearing it!”** Then rejoice together in song, in dance, and in praise. The Goodness of YæHúwaH is sprouting within us, and we cannot hold back the fruit appearing on our branches! Thanks to ALhhim. When our eyes are upon the Tree of Lives within us, we greatly desire the full branching of our Names; however, if our eyes are upon veils of our mortality, we have yet to see the glory of our Name’s Tree, for it is hidden within.

#### THE SERPENT OF THE TRIBES

“Dan judges to unify and thereby establish the tribes/branches of YishARAL as one people.” **The assembled eyes—congruent rings of a snake—form a body for the Serpent of Wisdom whereby one is able to make judgments. The body is overlaid with a skin containing many facets/diamond patterns through which the Light enters into the rings of the body.** “Yæhh appoints Dan ׀Δ as a serpent/ *Nachash*/ׁאׁנאׁ within the Derek/Way/ׁאΔ—to raise the *Teraysarunim* Δ of thoughts within the branches of a SeedName.” **A Derek is a path formed as a Thought branches.** *As branches come out of a tree, so the paths of life come out of our SeedName. We walk in the paths that we create through our thoughts. Our branches of mind go before us creating paths for us to tread. The paths of Light that we walk upon are according to the origin of our Name. As each tree is a unique pattern of branches coming out of its seed, so each one walks according to the Light patterns in their SeedName. As a thought is formed, we walk through the entrance of Derek. Our thoughts project our forward activities which are extensions of our Name and from that which we are drawn. Being that we are individual branches of a whole, our Names are designed as unique patterns to be perceived solely. To see ourselves in the paths of our Name is both liberating and assuring whereby we not following another blindly. One hears people say, “I wonder what got me on this road,” etc. The mystery of our location is within us.*

Dan is depicted as “an adder/*Shephiphun*/ׁאׁאׁאׁ to elevate the **Arúæch/path/procedures of life/light**/ׁאׁאׁ. The serpent stings the heel of the horse so that the rider falls to conform to the judgment [Sepher Maoshah BeRashshith/Gen 49:16-18; SMS/Acts 9:4]. **The Arúæch** is an unfolding path within the branches. There is the Way/Derek. Within the Way is the Path/Arúæch. The Path is the way the branches grow. Yaoquv gives the prophecy of Dan to be the Way and the Path amongst the people. “For your reclamation/salvation, *the inner unfoldment* lies in wait/expectation for YæHúwaH [SMB/Gen 49:18].” All within us has an expectation of the Unity of our Name to arise from within our state of residence. The overseeing Mind/Yaoquv patiently waits—with expectations—for the Unity of Life to arise within the Offspring of the Twelve. As a farmer waits with expectations for the maturing of the seed harvest, so the Fathers of Light anticipate the paths of our Seed to form as branches to bear fruit.

The rising of the Name amidst the branches is the salvation/reclamation of all that the mind has extended. This is the message of the prophet Yirmeyahu: “Affirmed in YæHúwaH of our ALhhim is the salvation of YishARAL.” As the oneness Principle rises from within the Seed, the branches comprehend the Name to which they belong; and hence, they are gathered unto the collective wholeness unto their salvation—reclaiming the State of Light from which they come. In being saved we are

gathered to the folds of Light. When lost we are as sheep scattered without a shepherd. The means to reclaim all thoughts and states is the ascension of the Name YæHúwaH—the Oneness of Name—within the branches. As a serpent, we are *able to judge oneself* and therefore *able to transform oneself—to shed former states*. Dan elevates the consciousness of our united branches. One who evaluates themselves can also transform themselves and produce new garments/skins. The serpent strikes the horse—the carrier of an illusion so that both the rider—the messenger, and the one carrying the message, the horse, fall together [Sepher Yetsiat Metsryim/Exodus 15:21; Tehillah/Psalm 76:6].

The elevation of the Way and the Paths are obtained through the House of Dan within us. The serpent rises from off its belly out of the dust—amidst clouds of thoughts. **As the branches of a Tree are configured, there is a pole for the serpent to ascend.** According to the height of the branches so is the head of one's serpent. From our branching Thought configurations, one comprehends the workings of the Mishkan/Tabernacle to be configurations of one's inward branches. Thus, when maShayh/Moses says to the House of YishARAL to make the Mishkan, and specifically to make the Ark, the Altar, the Menurahh, etc., the teachings of maShayh disclose how one configures the branches of their Name into a dwelling place for their spirit. As your branches are configured according to the House of YæHúwaH, one is engaged in all of the workings of the Mishkan—the dwelling of YæHúwaH and the on-going activities within the Mind of YæHúwaH.

**The serpent extends as the tongue of the Breath comes forth out of hiding.** Attached to the serpent are the organs of the body. The organs are as lands attached to a river that runs from the mouth to the anus. Though there are no legs or arms, the serpent moves by its tongue even as we move according to our Words. In that all things come to appear through speech, the 30 foot long serpent coiled within our body rises upon the crown of our heads to govern over our lands as Pharaoh. The Egyptian Uraeus upon the head of Pharaoh is a stylized form of a spitting cobra used as a symbol of sovereignty, royalty, deity, and divine authority in ancient Egypt.

*In the midsts of Fathers* is the Chair of Reshun—the Thoughts of Fire from the Collective Mind that both conceal and reveal. From the Seat of Reshun are 12 thrones on the left and 12 thrones on the right. Numerically, the Fathers are depicted as 12 **3** 123456789101112. **In that the properties of Light are able to generate expressions or Faces of Light, they are called Fathers—The Principles of a house or the Source of appearances.** The Faces of the 15 Fathers are seen in the faces/phases of the moon's rotation which abide in a Circle of Understanding. The force of the moon regulates the waters and the earth that it surrounds.

That which the Fathers begat are called the Children of Light. As the offspring comprehend the Heads of the Fathers, they are One with the Fathers even as the body achieves oneness with the Thoughts of Light which form it, whereby the offspring comes to Oneness with the Father. The 15 Faces of the Lights emanate in 15 days from both sides of a month—from the full moon to the dark moon and from the dark moon to the full moon. These faces are called the 15 Names of the Fathers. Through looking into the Origins of Life, does one see a single entity sitting on a throne, or does one see into a Collectiveness of Light which corresponds to the parts of Light within their Collectivity? Do we need to anthropomorphize the Nature of Light and create images for our security? Or are we at rest to know that there are no anthropomorphic



supreme beings as we may have suspected through religious training? In that the formulations of Life are composed of congruent strands of Light, as emissions of the Fathers, then the foundations, as well as the security of a House, are of the Lights which do not fail. We, as houses of Light, are built upon Light and are kept by the Lights. In Them we are as They. Hence, there are no wants nor longings for anything other than what we are, for all riches of the Lights are embodied within us to share Collectively.

The Fathers are 15 Names which designate Works of Light. The works as the seasons radiate from the northeast to the southwest. The 15 Names are found in the parables of the Túwrah and the Prophets. *In the parables the Faces of the Fathers appear to disclose their attributes and positions of Light* [i.e. SMB/Gen 32:30; 35:9, Mt 18:10; Tehillah/Psalm 24:6]. The Gifts of Light are called collectively as the Name of Yæhh [10:10]. The Name of Yæhh אה denotes those on the left and right hands of Light. The Body or House in which the Fathers reside with their offspring is called the House of YæHúwaH, which is the full embodiment of the Hhúwa ÚWah Hhúwa, [55 9W4] in the midst of Twelve/Lammed. The Twelve primary embodiments of Thoughts in the Fathers are 15 𐤆, as clusters of five threes: [1,2] 3 + 3 + [456789/39/12] 3 + [10,11/21] 3 + [12] 3. The 12 of 3 5's contain the harmonic pairs of Thoughts in the Fathers. The sum Values of the 15 Fathers are 21 W, derived from clusters of seven threes: [1,2] 3 + 3 + [1,2] 3 + 3 + [456789/39/12] 3 + [10,11/21] 3 + [12] 3. The seven threes form the 7 Eyes or rings which house Wisdom, Understanding, and Knowledge of Lammed. These 3 7's are of the origins of the 3 Eyes of Reshun in which are the 7 Oyin Eyes of the Fathers, formed as the Fathers are positioned upon the Seven Hills [see chart in BHM Offerings of Ayshshur: The Seven Hills of the HhaAúvim]. The 7 Eyes of the Fathers form the Seven Spirits of ALhchim to contain their thoughts communicated by the 21 Letters of Fire/Shayin. The thoughts of the Fathers are transmitted via the Numbers and Letters of ALhchim in a Seed whereby they are uttered and written. The sum of the Fathers is sown within a SeedName. As the Eyes of a Name open from within their Seed they behold the Wisdom, Understanding and Knowledge of the Fathers. **The Circle of the Shayin-Semek W𐤆 Ring bears the House of Dan—the Spirit of Discernment and their Creations.** In the House of the Fathers—the Shayin-Semek W𐤆 Ring—all Names appear from the altars of the Fathers and then are sown as SeedNames in the 7 Rings of Fire for their service in the House of YæHúwaH.

#### YAOQUV—THE MIND OF KNOWLEDGE ARRANGES THE BRANCHES

The elevation of the Serpent, known as the Oyin Body, rises from the foundation of the loins by arranging the tribal branches of a Name into the Trees of Lives. As we enter into the Light activities of Thought within the Oyin Body, we arrange our sticks/branches upon the altar. [For further details consult BHM: The Service of the Mishkan—Tabernacle, and the Offerings of the Twelve Tribes.]

The branches are configured in pairs as they are laid upon the altar. The first pair of branches are the sticks of Aparryim and Yahúdah. As one unites their branches of Aparryim and Yahúdah they create a square from which they rise upon the foundation laid. As the square expands, it forms a cube of eight corners. The base is comprised of four corners for the Houses of Wisdom: Yahúdah/E and Aparryim/W with their corners of Dan/N and RAúwaben/S. As the base begins to expand, Yahúdah extends the east into the south forming a dazzling realm of gems. Aparryim spreads out the west into



the north. The expanse of the base causes the camps of RAúwaben in the south and Dan in the north to arise to the top plate of the cube. The cube thereby is a formation of the Crowns of Wisdom which rise to the corners to govern all within the lands of the Oyin. These eight corners are known as the 8 Dalluth—pyramids/corners or the Paths of Wisdom.

Through uniting the Breaths of paired Names, as the Breaths of two Rings, the four sided base expands unto twelve sides. Through the expansion of **the cube**, the Fiery Serpent of Dan appears with its head at the apex. The Serpent coils as paired strands of Thought are drawn out of the unified paired Names within the Seed. These strands of Thoughts are at liberty to be suspended unto each other, for they hold nothing unto themselves.

They realize that they are complete together. As two sides of the Spirit are one, they are in need of nothing. Therefore, they remain not bound nor enslaved to anything except to the Oneness of the Fathers in which have perfect liberty.

From the midst of the base arises the interior shaft of Understanding. The shaft is formed by the paired Names of Maneshayh and Yishshakkar. The shaft of Maneshayh and Yishshakkar extends from that which is beneath unto that which is above via which the Serpent ascends from the base of Aparryim and Yahúdah to the upper chambers of RAúwaben and Dan. **In making the ascension of the daily offering, the eyes of a Seed are opened enabling a Name to see through their Rings. All have eyes, yet not all see; for when the Eyes of their Name are yet concealed they are as those blind from birth. The eyes are unveiled within a SeedName though the unfoldment of their Rings in the Fire whereby one sees through the Rings within them.** These eyes are the Rings of ALhhim, whereby they are not swallowed up by fleshly visions which stop-them-up as wells filled with earth, as when the ground/body opens and engulfs the eyes of RAúwaben [CHP/Num 16:27-33].

As one rises upon the shaft of Understanding they come to the full measurement of the Name—unto meShich. Bayinah/Understanding provides the means of ascension. **As we walk in the pathways of Wisdom within us**, we rise unto the Crown of Wisdom at the upper corners of Dan and RAúwaben [The Breath and its Rings] via Understanding. The Understanding in the midst of the cube, as a pendulum, keeps the sides squared with one another to maintain the proportions of thought and balance amongst the branches.

As one establishes their branches in pairs they create a platform of Wisdom through which their branches arise by Understanding. With Wisdom and Understanding we arrange the pieces upon the altar and perform the deeds for our service to the Collective. Plato said that utopia is attained as each person does what is best suited by Nature. We may clarify this further, that utopia is entered as each Name performs what is determined in the Unified Consciousness of the Lights from which a Name is sent into the world on behalf of the Collective.

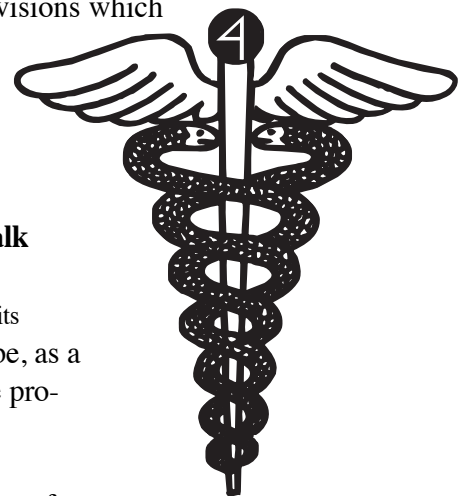

As the serpent rises upon the pole of Yishshakkar and Maneshayh all is seen and discerned from the Head of the North—the perspective of Dan—from which side the offering is opened [Teúwrat HhaKuwáhnim/Lev 1:11]. We designate each part within us to the Service of the Collective by placing each part of the offering upon the four sided cubed altar. Each part is set as stones according to their places of service—according to the arrangement of Thought in the Mind of YæHúwaH. As we behold the functions of our branches, we Name—read them according to the attributes of each house. In reading inwardly, we examine our parts and come to Knowledge of the Thoughts of Light woven from our Breaths.

Around the pole comes forth the paired branches of Knowledge—those of Beniymán and Zebúwlan. These are the foundational Names of Knowledge for they contain within them the Principles of Thoughts and their Dwellings. According to the Concepts/Seeds of Wisdom we occupy space, areas designated for Thought expansion/expression. Upon the Seeds of Wisdom arising from Aparryim/the loins, there is the strength to occupy the Earth which is appointed for each Name's inheritance. The Seeds of Beniymán are sown in the fertile valleys of Zebúwlan whereby their full traits of Knowledge are displayed. Beniymán determines our States of Residence. Where the Seeds are placed, that is where one resides. Hence, as one sows concepts unto the natural within their members, so one resides in the natural; and as one sows Seeds unto their Breath, they reside in all States of Spirit.

First a SeedName forms a base/foundation of associations and then begins to run like a vine. Out of this valley, the Serpent brings forth its head and commences to look around to behold all that is within its base. The branches of Dan and RAúwaben come to the zenith of the staff. That which is of the foundation of Wisdom in Dan, judges all emerging concepts by observing all things through one's eyes—the Offspring of RAúwaben which open in Beniymán and Zebúwlan. As the Head of the Serpent rises, all that is seen is heard/comprehended through the branches of Ayshshur and Shamoúnn which now appear. i.e. As we release sounds from our Spirit we make a place for hearing. By making utterances of our Breaths, we form the ears. The ears of Shamoúnn amplify what is seen. Thus the ears are positioned behind the eyes to catch all vibrations. However; before the frequencies can be heard and absorbed, they are broken down by Ayshshur—in the stomach—which is the body of Dan to affirm or negate that which has been observed and evaluated. As we listen to affirm the Voice of Dan, we come to hear or comprehend, with Understanding, that which Wisdom has discerned. Following the comprehension, the paired thought of Nephethi and Gad come forth whereby the mouth declares/speaks the illumination of the meditation. Speaking the illumination engages the hands to fulfill the foundation of Wisdom in Knowledge. In speaking out of deep contemplations, comes the projection of thought whereby we surround ourselves with a House of Light and put on the perfect attire/garments of Light. In speaking, our soul becomes a life-giving intelligence. Our skins are renewed according to the words that we utter. The garments of our Name are whitened and are maintained spot-free via the Words of Fire coming from our mouths. The pure thoughts are woven in circles around us forming our daily garment. The mouth is sanctified unto the base of Wisdom whereby the Thoughts of Light are expressed.

## THE JOURNEY OF A NAME

The vine that comes out of a Seed enters into various states of lands. From this metaphor, the Names in the Túwrah move from place to place. The journey of a Name is conveyed through parables whereby what is written is a guide and a record for every Name that comes into the world. A Seed breaks forth from the waters of Maneshayh/testes and becomes planted into the waters of Ayshshur/womb. As the sprout of Life comes out of the waters of Ayshshur, coined as the Red Sea—The Sea of Reeds, the sprout of a Name is called *a reed*. The Sea of Reeds is the state of a Name as it comes up out of the waters of Metsryim/Egypt. Through emergence of a reed the Life in the Seed transverses from the Sea to the River. The river is called The Jordan/HhaYarrdenn via which one enters into the Word State—the formularies of Light that are in the Seed. A Name rises from the waters of the earth into the mind of the heavens from which it has come. The Names of the locations in the Túwrah refer to states of development of a Name and their level of activities. When one goes on an expedition to find the ark of Núwach/Noah or the ark of the covenant they need a map of the anatomy depicting the progressions of a Life; otherwise, the pursuit is in vain. The reading of the places in the Túwrah without an understanding of the place where one resides leads the mind astray in trying to plot a map to discern the journeys of the Twelve Houses. A Name breaks forth from the waters of Moab [reproductive area] to be planted in the waters of the womb [stomach area]. The womb is called the Sea of Reeds [the Red Sea] from which a plant transverses or crosses the waters of Knowledge [heart area] into the States of their Words.

**The States of the Words of a Name** are called "the promised land," literally:  $\text{O}^{\text{A}}\text{W}^{\text{Y}} \text{4W}^{\text{Z}}$   $\text{r}^{\text{A}}\text{Z}^{\text{A}}$ —*the State of verifying/assuring the fulfilment of the Words of a Name*. In **the Land of Fulfillment one lives according to the Words of their Name** verses abiding within the shadows or forms of their body—a state of definition yet to be fulfilled [SMB 50:24]. **When one lives according to the Thoughts of Light in their Seed, they reside in the State of their Words unto their full expression.** All states of passage are common to each of us, whereby there is no stranger in our midst. The lands in which one resides are filled with culture and interpretations of life which have been derived from various collections of writings. There are many cultural influences that shape society into groups of interpretation and thus their practices. Some are able to go beyond the cultural structure of how the texts are viewed; others limit themselves to the culture they are raised in and become isolated within that culture. Yet others are able to see their identity in Light whereby they move through and beyond the cultural influences they have become accustomed to know. One goes beyond serving forms in which they have entered and thereby they leave behind the struggles in Moab. As one seeks for freedom from vain servitude they pass through the waters of their Origin, conveyed as the Sea of Reeds. As they emerge from the waters they leave behind their previous deeds **in light of their origins to perform the offerings—the expense of their members within the Collective Goodness of the Lights of the Fathers and their Neighbors**. In coming to the lands of Nephethli, they cross the Yarrdenn/Jordan River that flows from the heart. They enter into the land that is filled with the Consciousness of their Word Base of Being. In the promised lands, one lives unto the Source and unto the true Nature of their Life which has no end/termination, for the Words of a Name are The Eternal Name.

## THE HOUSE OF DAN

**The House of Dan is three parts.** These three parts are in every Spirit which are activated by Breath of ALhhim into the nostrils—the breathing apparatus of Dan. There are the head, the body, and the Life which runs as the blood of the spirit, pulsating within the mind and its parts to carry the messages of Dan unto the uttermost parts of the earth. Dan is one of four Heads of YishARAL [CHP/Numb 2: 25-31]: Dan is the Head of the north Lights. Yahúdah is the Head of the east Lights; RAúwaben, the Head of the south Lights, and Aparityim, the Head of the west Lights. The 4 Heads each have a body and the Life that flows in them.

**The chamber of the lungs** is the House of Breath called after the Name of Dan. *The Breath is impartial which gives of itself to every part of the body.* The Breath takes up residence in a Body of Waters as it enters in the womb of *Ayshshur*. The waters of the womb are those of one's Mother of Antiquity. The House of Ayshshur is on the north side of YishARAL and corresponds to the **diaphragm and the waters of the womb** in which the Breath of Dan resides. i.e. One gets the wind knocked out of them when they are hit in the stomach where the Breath resides. *The Life of the Breath* of Dan is **the Blood that runs from the land of Nephethi—the heart**. The three chambers are conveyed in the Name of **DAN: Dan Ayshshur, and Nephethi**. These three parts are One House, as the Breath, the Waters, and Blood are One—in agreement [1 Yahuchannan 5:8]. The House of Dan houses the Lights of the north—the seat of mysteries and judgments. In the day that a spirit is made from the altars of the Most High, it is called from the north side—by discernment. The house of every specie is built as an embodiment for the Lights. Each Name and its parts are appointed to house the glory of the Fathers.

*Yaoquv—the Father of Knowledge assembles all members within a land for comprehension. As the Head of the Branches of Mind, Yaoquv* speaks the words of blessings upon its branches. Likewise, one is of the Mind of Yaoquv as one reads all that is within their rooms and blesses its members unto their full expression/salvation in the Unity of YæHúwaH. The prophecies of Yaoquv are how the Mind of Knowledge beholds and reads all within one's Name. As the sayings are uttered and comprehended, the states of the inner tribes are transformed unto their collective expansion/blessing [Sepher Maoshah BeRashshith/Gen 49:2].

Dan judges the flow of thoughts unto assembling all parts with Understanding—Bayinah. **As the mind discerns how every part fits together and how Names are joined together, the separations that divide us are dissolved.** The judgments of Dan are unto unifying the tribes of YishARAL. Every judgment considers all of the tribes/branches of Mind within us and how they are One. Via the judgments, Dan establishes *a unified people/ΥϞΟ*—a unified consciousness of all assembled by our spirit. *In that all parts of the spirit, as one hears the spirit they are one.* **A People** is a comprehension *Ο* of thought that flows *Ϟ* as clusters/groups *Υ* of the whole. As Dan unifies the parts and the pairs within a name, the people—the consciousness—is healed. In the process of evaluating all things inwardly, the Mind of Bayinah is carried forth with full expression without defect or distortion.

The Mind of Yaoquv reads the spirit residing within the body as a coiled serpent [i.e. the gi tract]. **As we affirm Dan as the serpent in us,** we affirm that all of our parts are joined as one. There are

no obstructions of thought nor any impediment/blockages within our houses to cause an illusion to arise within us. Illusions come out of separateness—by seeing things apart from their unity; illusions fall through unified discernment of all within us. The serpent in the garden is as a deceiving tongue which speaks from levels of observations **verses** from the depths of discernment. As our members are assembled as one, we are the people of YæHúwaH. We are a flow of the Unified Consciousness which dwells within us from head to tail to transmit the assembled thoughts of Light in our SeedName. As we enter into the unified Oyin circle of consciousness with all spirits, hand-for-hand, we extend the Oyin from the wells of our habitations unto springs of everlasting life! We pass from the waters of death [separations] unto the waters of Life [perpetual flow of Unity spirit to spirit].

## יΔ

The Name Dan/יΔ, is composed of two Letters, the Dallath/4/Δ and Neúwn/14/י, The sum of the Name is 18/9/י/⊕. The House of Dan is composed of the Spirit of Liberty, capable of transformations with an ability to weave the 9 threads of Thoughts into a garment of an Oyin Body—an Eternal Circle. As one of the four corners of Wisdom, Dan weaves the Numbers of Wisdom in Yahúdah which are transmitted to RAúwaben—within the Eyes for extraction, and then passes them to Aparryim for expression into a multi-colored garment. The discernment or activation of Numbers originates in Dan. Via the discernment of joining all Names and parts—via the nine/Tæyth/⊕, all angles are considered to determine a wise judgment. Via Dan we examine a matter from all sides and from the four mouths/corners of our habitations. We judge a matter and thereafter conclude an answer. We look at the base/reason, the walls/expressions which uphold it, and the composite values/the inner numbers to reach a judgement. The 9 threads are discussed later in this study.

Dan is a Teraysarun/Pyramid of the extended Neúwn Mind/יΔ. Via Dan, all within the Teraysarun of Names are fully extended by Breath. **There is nothing hid within us. Our Breath carries our thoughts and projects them before our eyes for discernment. Many dreams originate in Dan** whereby our thoughts are projected on a screen for viewing. *Dreams are like movies. The other end of the branch of Dan is the branch of RAúwaben in which dreams are played within the 7 Eyes of our Name.* Dreams provide direction and discernment of what we are observing and thinking. Our thoughts enter into the paths of Dan—into the fields of Breath through which they are interpreted as messages of Dan to be revealed in RAúwaben. When we see and hear in a dream, the messages are coming from the head and the body of the north—out of Dan and Ayshshur. When we have a dream in which we see and hear and also speak, then the full side of the north is relaying messages through the three parts of the south: in RAúwaben, Shamoúnn, and Gad.

Dan reveals all to us via the Breath. Vain thoughts are attacked by Dan, like a serpent that arises to bite the heel of a horse. In attacking the horse, the serpent attacks the image that is carrying the thought as well as the thought held inwardly. A direction in which we are moving is often corrected by one who takes heed to their dreams. How can we tell if the dream is affirming or correcting a direction? When the dream conveys our importance or separateness, it is mirroring one moving apart from our position in the Collective. Such dreams make us to appear as important in the dream, etc. Dreams also mirror to us our focus and what we desire; they heighten our awareness to how we are devoting our Mind and faculties. Hence, dreams are means to alert us to make evaluations in accordance with Dan. When the dream shows our humility and collectiveness, it is affirming our

Name and the work that we are to fulfill. Some dreams teach us or awaken us to Principles that we are readied to receive. There are dreams that lead to healing and resolutions. Other dreams seek to balance the collection of thoughts assembled. Yet other dreams direct us unto an activity wherein we see ourselves performing the assignments we are appointed to in the House of YæHúwaH. Dreams tap into our origins to guide us in accordance with our mission. Other dreams lead us to evaluate our expressions. They often include people with whom we have been, will be, or are in contact. These dreams assist us to evaluate our relationships and proceedings. Dreams also include paths that are opening up for further progressions. Each dream has its significance and should be committed unto the House of Dan and Aharúwan to determine the meanings. Thus, **there are no secrets. All inward thoughts are evaluated, as breathed upon through the lungs and examined at the gates—in our mouths. They are literally carried upon the wings of Breath. Because nothing is hid from us, we come to know all things of former days, that which we are now, and that which we are becoming. Our Breath reveals it.**

**We have access to all within us via Breath which transcends all forms and is capable to interact with the Breaths that inhabit all spaces.** The lion is a symbol of the Rúæch/spirit. Our spirit becomes through the root of Dæúwd/David/ΔΥΔ—the union of two Teraysarunim/pyramids. As two Rings of ALhhim unite in the Fires of the Fathers, a spirit is born as a lion capable of governing its den. Each spirit is a union of two Dallath/Teraysarun into one, whereby only by Rúæch/Breath are we able to unite our Names into a clustered habitation to build the House of YæHúwaH. While the flesh divides, the Spirit unites. *The Lion of Yahúdah* —is *the Spirit of the Numbers* which enables all Teraysarunim of Names to be fitted together in one house. According to the Spirit of Numbers one is able to break the seals to read all things inwardly. The readings occur as Dan and Yahúdah are joined whereby what is in darkness/layered/written is opened in Light. Dan and Yahúdah bear the Lights of Chækúwmah in the north and in the east sides respectfully. What is laid in darkness appears at day break. When two Names are joined their seals are broken to reveal the inner contents. The spirit passes through the seals and melts them with the fire of its breath. The breaking of the seals pertain to the coverings and body parts in which all inscriptions/scrolls are written. The breaking of the seals occur in seven openings or rings of a Name, each sealed by the coverings around them. As an egg is broken from within, the seals of the membrane are broken by the Breath of the mouth of the chick. The seals surround the inscriptions of a Name to guard/protect the veins of life through which a tree branches. Seals over the scrolls of a Name are as sealed nodes from which a branch sprouts from a tree. The seven seals of each Spirit contain the inscriptions of a Name. The seals are at the openings of the seven wells or centres of Yapheth around which the scrolls of Life are rolled.

From one cell of two rings, an inner and outer ring, our Spirit forms a body for a residence. The inner and outer ringed cell distinguishes itself into two sides, then four quadrants, and then eight corners. From the eight/Chayit 𐌆 primary cells, Understanding draws from the ALphæh Seed 𐌀 all cellular constructs around the Semek 𐌆 pattern. These primary eight cells are the 8 gates/corners of the cube. In the midst of 1 and 8 are seven levels. These seven levels are spaces that form the Oyin-Zayin Body. A full description of the Oyin-Zayin Body and the 7 Rings of a Spirit follow in this document. The ten segments of our body is a full extension of Unity depicted by the Yeúwd/10 which is the expansion of One/1. The ten parts of the Oyin-Zayin Body are the extensions of the Unified Mind in which the Serpent of Dan resides.

## THE TWO SIDES OF SPIRIT

## THE NORTH/LEFT SIDE AFFECTS THE EXPANSION AND EXPRESSION OF THE SOUTH/RIGHT SIDE

The discernment of Dan determines the levels in which the eyes of RAúwaben see and operate. The discernment of a spirit affects how a spirit sees. Grid works, as six spokes in a wheel, are formed by arranging the 12 branches upon the altar. The branches are arranged as one performs the daily oylah offering which positions the twelve members for instruction and service. The grid work of one house affects the well-being of other houses of spirit even as the twelve members of your body affect the well-being of each part. A small word or deed has far reaching consequences. The triggering of the thoughts of Dan within all other houses is understood how when one member affects another. i.e. What is seen or heard or tasted, etc. has a corresponding affect on the entire body. The moon enters into one of our houses each day. The affects of the Light of the moon entering each evening affects all members. When the moon/light of Understanding passes monthly into the camp/constellation of Dan judgment is triggered within the spirit to make evaluations of the house residing in the sun/Chækúwmah. Our eyes change focus as Dan activates judgement in our seven eyes of spirit. When a matter is properly discerned, there are no distortions in vision. We see in part as we discern in part. When we discern from all angles we see 360°—by the Numbers of the ALhlim Shayin-Semek/360 of Dan. As the eyes are connected and move with Dan, the eyes embody the Thoughts of our Breath.

One beholds all parts which a spirit makes according to the extent of its Numbers as one sees into and through the Fire of Dan. The eyes of a Seed, as the rings of a tree, form a body for the Fire of Dan. The body of a spirit is twelve houses or branches which are conveyed as tribes in the Túwrahh. Whether one sees the Twelve as groups of peoples or parts of the body, the Twelve and their operations are the same in a body or in the earth. When one looks at that which is within them, they behold what the Fire of their Name has made. The Fire remains burning upon the Altars of the Aúvim/Fathers whereby the spirit and its houses are continually fashioned by the extent of one's Numbers and their combinations. **To see oneself is to comprehend the Fire of their spirit and the state in which one's spirit is abiding.** The spirit of a Name makes itself a house according to what it draws out of its seed. As a house is made, a spirit looks at what it has made and how it is being used to gain understanding. In everything that the Spirit of Dan makes one beholds the Thoughts and Numbers of one's Name, for the spirit takes of the Numbers and forms them into configurations to make a house. Through observations within the Numbers of a Name a spirit extends itself from where it resides into another state of its Light, whereby one is able to be in multi-places at once. As a set of Numbers are established in one state, subsequent states of a Name are built upon them whereby one lives within the domains of its Light. As a kingdom, a Name spreads out like a vine to occupy a city to city—from gathering illuminations, and from land to land until the entire states of a Name are under the domain of its Light. The processes of transposing oneself are through the offerings of Ayshshur and Shamoúnn which house the Thoughts of Dan.

Affirmations of judgments are through the branch of Ayshshur, the body of Dan. What we affirm affects our levels of hearing. Affirmations and hearing are means to amplify and establish all discerned and seen by Dan and RAúwaben. Via the contemplations of the decisions of Dan in Nephethi



[the heart], we speak discerningly through our House of Gad [speech]. The contemplations of the heart determine the depth and level of our communications. From our words flow expressions. With our words we make the garments of Aparryim in conjunction with the values/numbers in Yahúdah. Every expression is a positioning and a revelation of the values of our Name being unfolded through our words. The combined thoughts and values are stored in Maneshayh from which they ascend into mastery levels of Consciousness in Yishshakkar. *With each transition from Maneshayh, our level of service changes in accord with Consciousness.* We forget/relinquish former days to press unto the high calling *in meShich—the full drawing out of our spirit through ascensions* אַשְׁכּוּל. ***The ascent of the Thoughts of Dan passing through all of the houses*** results in a new mind and a new state secured through Beniyman and Zebúwlan. According to transitions made through Maneshayh, we increase in skill, labor, and fulfillment of our Name amongst Names. Through renewing the Principles of the Fathers which are laid-up in our Seed, we create a foundation upon which we build a house upon the rock in Zebúwlan. Our Life is abundant—ever increasing in Beniyman to abide in Zebúwlan. **We dwell in the same Light in which the thoughts of our Names are originally solidified in the Fathers.** The Light strands in our Seed are those from the days in which the Seed is made, whereby everyone has a unique fingerprint of encircled rings. In that we bear the Light in our SeedName, we abide in the Light in which the SeedName is woven and called in ALhhim.

As the judgments of Dan come into Zebúwlan one comes as *the son of man—the formulations of the Neúwn Mind*. The Thoughts of the Fathers are set in Dan to appear and to govern within the fields of a Name [Matt 25:31-46]. The separations/distinctions of the sheep and the goats are the analysis of *the ideas that lead us—those of the goats, and the states of our social dwellings—those of the sheep*. We examine the goats and the sheep within the House of our Name. The *goats and sheep* convey the strength and humility in the ÚWah Bayit Ring of a house. By hearing the voice directing us or by hearing the voice that leads to our fulfillment, *we sort out our offerings as we take from our flocks of understanding to perform our service within the Collective*. Wayward thoughts and deeds are put to death. Those which are unto life are brought to our altars and their Words are gathered into our mind and members. Each Name makes these judgments within their houses as they come upon their throne! Each Name judges their own flocks and determines what is acceptable to Dan—the judgments of Light! From the harvest of all thoughts and deeds in one's mind, the House of Dan rises and is distinguished as the Judge of a Name.

The SeedHead formed in Beniyman, by the Lights of the Fathers, is the Mind of meShich which emerges from the lands in which it is sown. The blessings of the Seed are the means for the fulness of joy and the abundance of Life in your Name. The ideas or seeds formed in Dan determine the thoughts, progressions and the illuminations that one bears. In this brief overview, what commences in Dan goes full circle unto its appearance in the coming of *the Offspring of ALhhim*. From the initiations of Dan unto their appearance every house carries and weaves the thoughts of Dan unto their full appearing as the Offspring of ALhhim. ***The results of all sown by ALhhim is the end of the world; what has been in the SeedHead releases offspring of Adim to appear in the final days.***

A spirit comes/appears in a state to which it is foreordained to establish the domain of ALhhim in that place. You are sent as a blessing—to be an expansion of Light. You come to serve, not to be served. Through your service you are abundantly rewarded. The spirit comes as a Seed of the Life of the Fathers. Our spirits are offspring of the Shayin-Semek—the Fire and the Wood/Teachings of the

Fathers in every offering of ALhhim. **From Fire and Wood of the offerings of ALhhim, the spirits of all Names are born. From the Spirit of Shayin comes the spirit of every Name, and from Semek comes the tree of every Name.** The Seed of ALhhim is an encapsulation of the Light formed by the weavings in the Rings of ALhhim. By giving what is formed in ALhhim, the Names of ALhhim are born through their offerings. The spirit of a Name comes/appears through one of the seven branches of Semek—The Tree of Fire. As the fruit of a tree appears on its branches, so does a Name appear on the branches of Semek—the seven-fold branches of agreement composed by BaarShevog—Father of Covenants. What is in a spirit appears unto the full faces of the Fathers as its SeedName is sown in the Rings of ALhhim. Through the patterns of the Light in a spirit one creates a habitation and then fills its house with the attributes of its Seed—filling its 7 Rings/Eyes which are made in the likeness of ALhhim [SMB Gen 1:27; Zekkaryah/Zech 3:9; 4:10; Chazun/Rev 1:4]. The House of a Name is built by the patterns above to be filled with the Lights of the Fathers. The offspring of the Fathers are a lamp to bear their Lights [Chazun/Rev 21:22-27]. As the Lights in a Seed break forth, the Kingdom of ALhhim is established by the Name of the spirit in the place to which they are appointed.

As the spirit enters into the 7 Eyes of its Name, which are drawn out of itself, there is a total discernment of oneself. One comes to the 7th Eye of rest and enters into the consolation of its perfection. Through knowing ALhhim one lives in meShich—the head of its Name—the assembled impartial thoughts begotten of the Fathers.

The discernment of a spirit rises from its Seed as a Judge. That which has been discerned to be good before the worlds are made rises from the Seed to judge/evaluate the deeds and states of one's lands. The judge burns what is unprofitable by its Breath of Fire. By breathing on a thought, you can fan it or eliminate it by your spirit! Every thought can be analyzed by bringing it into the column of Light from the crown of the head to the loins—from Gomer unto Tiras. That which is honorable is in agreement with the Light and is therefore gathered within one's barns as the fruit of its days.

The **Shayin-Semek Ring of ALhhim** is known as **the Fire in the Wood** whereby the Fire of ALhhim does not go out on one's altar. From the House of Shayin-Semek the House of Dan is born, which is the origin of the spirit. When the Fire of the Fathers is discerned and analyzed within oneself, one finds in the ashes the patterns of the Trees of Semek. In W 21 are ₪ 15. The ₪ 15 Fathers of Spirit are called the Fire in the bones. **When this Fire is fanned, the bones begin to join unto the full emergence of YishARAL** [YechúwzeqAL/Ezek 37]. In the midst of the W Fire/21 and the ₪ wood/15 is the Tsædda ʔ 90 [20 19 18 17 16]. Tsædda ʔ is the Law of Liberty. As one analyzes all within the Structure of Spirit, the Law is written in their inner parts of their Tree. **The 7 scrolls from each Seed is where one writes the teachings of their spirit as the Words are performed by their hand.**

That which is to be discerned within your spirit is the Fire and the Teachings of the Fathers displayed within your faces of embodiment. **There is no evil in your Name.** There is no evil in you for you are made by the Words of the Fathers in an image of ALhhim. Should one think there is evil in themselves, it is because one does not know what is in your spirit [Tehillah/Ps 85:12, Yaoquv/Jas 1:17]. When one knows themselves they come to know the Fathers also. When one knows their spirit they no longer walk in outer darkness—beyond the woven cloth/bodies/houses of their spirit. We may make a place for evil to reside like one packs a luggage to carry their thoughts; however, evil is not in your Name nor spirit, nor can it. Your Breath can annihilate all evil, but never can the Breath

destroy the good. *By Dan—by the very Breath of Life*—one discerns that there is only goodness in you *whereby one* turns their faces/expressions—the ways that one thinks and acts towards the Faces of Semek—the Fathers from which you have your being. Is your spirit not impartial? Does your spirit not seek for the well-being of all of your parts? When you breathe, is it not on behalf of every part, or does one withhold the breath from any part? Though the mind formed by external perceptions may mis-align or mis-treat one's members, the spirit will not, nor can it deny its own creation! By knowing the goodness of ALhhim one forsakes wayward expressions of illusive thoughts that turn the eyes from seeing the Faces of the Collective. Though one fears hell-fire, brimstone or punishment, such repentance is selfishly motivated to escape rather than to become. The “fears/perspectives” that bring change are the fears/observations of Wisdom in which one sees all things as one. ***The fact that your spirit loves, gives, and defends all of its members for the well-being of every part demonstrates that the impartial spirit of Dan is within you.*** Through the spirit of impartiality, one discerns that in them there is only the goodness of ALhhim. Anything not of this goodness is consumed by your breath whereby it does not come near your dwelling [Tehillah/Ps 111:10, Rom 2:4; II Kayphah/Peter 3:9].

In your spirit is *the Law of Liberty—the standard* that every person judges their thoughts and actions. The spirit judges according to the Words of ALhhim, for only by the Words of ALhhim can one truly know what is. Whatever is apart from the Words is dismissed as meaningless! As the Tsædda-Tsædda Ring is in the midst of Dan, the Tsædda-Tsædda is the body of Dan which is drawn out from the sides of Shayin-Semek. The Presence of the Tsædda-Tsædda of a spirit is apparent, for by Tsædda-Tsædda a spirit transforms itself from being invisible to visible. The body of one's habitation is made by the nothingness of its Breath! In drawing out from the sides of a spirit one creates *woman*—a body. What is drawn out of *man*—the *ayish*—appears by the giving what is in one's spirit. What the ALhhim have given from their rings are the offspring of ALhhim [SMB/Gen 5:1; Yúwsphah/Lk 3:38]. ALhhim is the head of a man/*ayish* in that each spirit comes from the Shayin and Semek of the offerings of ALhhim. *Ayish* is the head of the body/*ashayh*—what is formed by *ayish*. As a spirit gives from its sides, it forms a residing place. When a seed draws from its sides it produces a body into which its life enters. A spirit and its body are not limited to gender. This is the same for all spirits, animal or human, male or female, as well as for plants. When one slays a cow it is the same as slaying a man, for the body of the animal belongs to a spirit/an *ayish* [Yeshoyahu/Isa 66:1-4; Ecclesiastes 3:20-21]. When the meShich in you is drawn out from the sides of ALhhim, then the Father, from whom are the ALhhim, is all in all [Eph 4:6]. In that the Fathers are in all, everything is governed by the Lights whereby we abide together in peace and are citizens of one Kingdom [Yeshoyahu/Isa 11:1-9].

***The idea of drawing out is the foundation of the word, meShich/Messiah.*** The meShich is the beginning of every spirit/*ayish* as each spirit is a drawing out of the Sides of the Spirits of the Fathers. **As that which is being drawn out of your spirit, there is the coming of the meShich in you.** The Essenes composed parables to convey processes of this coming, a dawning of Consciousness. The drawing out of one's spirit is told through narratives whereby one comprehends the process of the coming of the meShich in themselves. The same process is told in the parable of maShayh/Moses who is drawn out of the waters. All of these stories are based on the realities of a spirit being drawn out from the Fathers and those Names drawn out of the ALhhim who breath into them the Breath of Life. The writers were not setting forth historical figures; rather they composed narratives to assist each Name to bring forth the glory of the Fathers in their spirit unto every mind being a high priest of their houses and every crowning Name as a king in their land.

When the religions of the world teach what is in spirit they lead the peoples unto the joy of their fulfillment; however, when personalities in the parables are set as icons in the minds of the people and special favored peoples are lifted above the Collective Sum, the inhabitants are drug into battles within themselves and each other. **The term, meShich מֵשִׁיחַ, means to draw out of one's spirit through ascensions until that which is in the seed of each Name is brought to the crown of a Name.** When the wheat seed is drawn out completely, a crown is formed at the top of the plant whereby there is the coming of the meShich—that which has been before the plant appears. The times of the harvest is known to the Fathers for the timing of the crown comes through *days—acts of Light* and by the *twelve hours—functions* within our spirit. As the Seven Eyes of a Name are opened, every Eye of Seven sees the meShich appearing in the clouds—within the heads of Consciousness forming from its collective thoughts of Light which rise from one's waters of embodiment.

When one believes there is evil in them they believe a lie. To take what is good and make it as evil is the lie of all lies. When the serpent, depicting the tongue, speaks of things beyond the structure of Light, it makes of no effect the Word of Truth/verification of what Light makes. Evil is a supposition—a vain interpretation apart from the Words of ALhhim. One engages in evil by committing to an illusion, a distortion of the whole. **Goodness is beholding the collectivity, sum reality of spirit.** To take away a fruit on a tree of Semek, one cuts short the collective wholeness. Taking away from spirit, soul or body are violations to one's state in Life and are in opposition to the Principles of the Fathers which have founded it [Yúwspah 15:18]. Whenever there is a taking away of the wholeness it cannot be reckoned. If one misses the mark, there are no points to count! Weakness in the eye is brought into the mind which yields confusion of purpose. The Words of ALhhim create only good—that which mutually loves and supports each other. The Eye of ALhhim sees only good! There is no evil in all the works of ALhhim! There is no evil made nor evil seen [SMB/Gen 1:31]. When the serpent/tongue of the beholder does not see the complete works of ALhhim they speak apart from the whole. Such leads to a partiality of thoughts and divisions. ***A lie is an illusion; it is nothing. Can you measure it, weigh it, count it, depend on it?*** The father of lies initiates and idea and then makes of the idea an illusion. A lie does not exist. A lie is formed by distorted perceptions in one's eye. When what is perceived is conceived, it brings forth a violation to the impartial orders of ALhhim. Should one see themselves separate from their ALhhim they deny meShich in them and wander in paths of illusions—abstractions of perceptions. When one holds illusions they form a mind devoid of what is in their spirit and subjects their members unto the thoughts in their mind. As one returns to know themselves in the likeness of ALhhim, the grip of the former mind is broken by ten plaques/strikes of Light—to reconfigure the mind.

Hindrances to perform the deeds of one's spirit are overcome through the meShich in them. Pseudo thoughts are eradicated by one's Breath whereby one is set free from the law of sin and death. Those who say that they cannot do the things they know they are to do struggle with illusions in their mind. **The victory to live in meShich comes by drawing out what is your spirit and bringing the thoughts of meShich to the mind.** By the spirit of meShich one triumphs over every vain thought and thereby walks according to the glory of the Fathers in them, a glory that does not fade nor pass away.

## FROM THE SIDE OF THE NORTH, THE BLOOD OF THE OYLAH FLOWS

Dan is the House from which all thoughts flourish as breath regulates what is formed in the womb and what flows from the heart. On the side of the north—the side of Dan, the morning and evening keveshim/humble ones/lambs are slain to release the flow of blood/Understanding for the day. According to the offerings of a day one enters into the instruction of the night to awaken unto the tasks of the morning. Via the flow of our observations we judge all things. **We do not judge unto death; rather, we evaluate all things unto Life whereby death is overthrown. We judge unto the Orders of ALhhim, whereby disorder is kept outside our houses. We judge unto peace whereby there are no more wars. We judge unto righteousness whereby there are no more fallen comrades. We see all Names ascending in Life.** If we judge unto war, we have yet to know the ways of peace. If we judge another so that they are condemned in our eyes, we have caused another to fall within our house; and hence, we hold their faults within us. Incomplete judgements leads to entrapments. Complete judgements lead to freedom and perfect Unity.

The Mind of Knowledge in Yaoquv is the degree of patriarchal Light to read the glory within our members. The Mind of Yaoquv/Jacob discloses all things to one's members as Yaoquv tells to the offspring what is to transpire—what is the outcome [SMB/Gen 49:1]. The members of one's house comprehends that which lies within them and therefore they serve one another according to the thoughts of Knowledge expressed by the unified Mind. We serve unto that which we are becoming. The obligation of every mind is to teach its body members. As one's children, our parts are derived from our SeedHead. When the Consciousness knows all things, it is the knowing of all things inwardly by word formulations [Yahuchannan/Jn 16:30].

**The serpent of Dan corresponds to ten coils/intervals of the trachea.** The windpipe depicts a pole with a coiled serpent upon it. The lungs depict the scales of judgments which hang at the sides of the pole of the trachea upon which the serpents climbs to observe all within itself.

Yaoquv's correlation of the twelve tribes/branches of mind as animals convey the associations of forms of spirit. Dan is likened unto serpents, for Dan is a House of Wisdom—as wise as a serpent. The two serpents of Dan, *the Nachash and the Shephiphun*, convey the Unity of Names. As coiled strands, the serpents serve one another. Together they maintain the court of their Temple as the Residence of the RuæchHhaALhhim. As Names transmit to one another by giving and receiving, they acquire a mind to discern/judge all things within and without. Both serpents of Dan are for judgment. One judges the actions and developments; the other judges the intent and the thoughts.

**The Nachash serpent** seeks to expound upon every trait and expression of Knowledge whereby one is wise unto salvation—always considering every trait to be in accord to the Name of YæHúwaH. The Nachash serpent slithers underground, within rocks and climbs unto the heights of a tree. Hence their perspectives are very broad to discern and to lead us into paths of expansion and blessing. The eyes of the serpent are pronounced above all other members, which shows the relationship of Dan/breathing with RAúwaben/sight.

**The Shephiphun serpent** has horns and eyes on the top of the head. The Name, Shephiphun, is comprised of two words: *Shephi* meaning to bow, couch low, depicting the inclination of humility,

and *Phun*, meaning to pause, conveying the attitude of patience, to wait with expectation. This serpent covers itself in dust and waits in a path for its prey. It is able to catch birds as they come near to peck at its eyes, interpreting the eyes for food. It is able to sting horses as they cross its path and cause the horse and rider to fall. The later judgment of the Shephiphun of Dan within us attacks that which carries or moves us in a direction apart from Wisdom. The horse is likened to a messenger carrying a thought. When a thought and the messenger carrying it become arrogant above the humility of Wisdom, a fall follows [Mishle/Proverbs 16:18]. Types of messages include: i.e. idolizing another person, fixing one's gaze on an illusion of grandeur, a fixation of personality, etc., which carries thoughts leading one from reality into paths of self-defeat. The Shephiphun maintains the order of Unity within the members and lies in the path in which we are walking even as our breath lies hidden within our bodies.

#### THE SEALING OF THE TRIBES—A MYSTERY

The House of Dan is not listed with the Houses of YishARAL who are sealed by the Ruæch/Breath [Chazun/The Revelation 7]. The Breath is as a Vine. The House of Dan, as Breath, consumes from every cellular construct within the body. All space in which Breath resides is consumed, integrated, married/joined with Breath. The House of Dan is the branch of YishARAL that provides Breath a home—a dwelling companion. In that Breath resides in the chambers of Dan, the House of Dan is already sealed. As Breath comes into its residence for an expansion of Name, it gathers whereby it does not depart empty-handed. Breath draws out of our waters, cultivates the lands of our members, and fills the spaces with attributes of ALhhim. All Wisdom, Understanding, and Knowledge that has been processed and mined out of the fields of our Name are gathered by Breath and carried unto its appointed habitation. Therefore, the House of Dan, is not absent from the Names of YishARAL, for it has been preserved/sealed by Breath for all succeeding States of Transformation and Service amongst the Union of Lights. [For further details consult BHM: The Kingdom of Names.] As insects seal their food, so Dan is sealed by the Ruæch HhaQudash/Breath of Sanctification. Hence, this tribal Name is not necessary to list with those to be sealed. All precious findings are wrapped as jewels by Breath, as bees that prepare a sealing wax to encase/seal their treasures. Every thought is analyzed by Breath to know its worth. As we take our thoughts into the judge's chambers of our lungs, Breath breathes through them and thereby discerns their worth. Every thought is placed on the scales to determine its weight and property. If it belongs to the House of Wisdom, it is a golden thought, or if it is a silver thought it is of the House of Understanding, or if it is of bronze, it belongs to the House of Knowledge. If it is one of these three, then one exhales over it to produce a secretion whereby it is sealed within the treasuries of each member. On the other hand, if the thought is troubling, disruptive, or corruptible as hay, wood, and stubble, then one breathes upon it to burn it up. [Thanks be to ALhhim who breaks the codes of mysteries and reveals unto babes the pure milk (whitened messages) from the Breasts of AL-Shaddai.]

Breath manages all thoughts and all that enters into the bodies. The entire house is a guest room for the dwelling Breath Name. Breath is acknowledged as the Prophet, the Seer within us. The body as the Great White Throne Room for the House of Dan in the north. It is *great* because *it is an expanse* of all Breath has nurtured. It is *white* because it is illuminated with the Thoughts of the Union of Lights. It is *a Throne* because it is the place of governing thoughts rising from the base of every Name. From this chair/throne we grant life to the ideas that pertain to a Name's position in the

Union, and we sentence to death thoughts that undermine or express themselves in manners adverse to the Union.

#### WE ARE TO JUDGE OURSELVES AND THE THOUGHTS WE CARRY

The parables of the disciples of Yahushúo depict the coming of Consciousness as a **Judge**. Through narratives of Yahushúo and the Twelve, the writers portray the Teacher of Consciousness. The Teacher gathers the twelve members within the body who are called to be disciplined—to be disciples. Consciousness does not come to judge/condemn the 12 members of parts of the mind, but rather to bring together the twelve to instruct them and bring them into unity with their founding Principle or Father.

By the Words of YæHúwaH alone we judge our thoughts and deeds with great satisfaction [Hebrews 4:12]. One is happy when matters are cleared up. Through analysis of our thoughts and deeds we sort out what pertains to our Name. As one affirms their totality, your Name dismisses the worthless and upholds with honor the attributes of your Father. What profit is obtained if we condemn each other from our own perspectives? Can we truly discern the value of another's servant? The results of judging another generates wranglings and disputes, and most often causes divisions. Should one submit to the judgment of another, one shifts the responsibility from their shoulders to another. Each are to discern and affirm their place in the Collective.

We rise in the east; we expand in the south; we gather in the west; and **in the north we discern the fruit of our members to rule upon their thrones** [Matthew 19:28]. The judge of your Name rises upon the 12 thrones of YishARAL to oversee all within your houses. Through consciousness of the thoughts we process daily, we make decisions to determine the values and positioning that each thought has in our houses. In the north we awaken as one coming out of sleep. Through the process of entering into the four sides of Light we come to the Great White Throne—unto **the judgment seat by disciplining all members within us to be whitened/enlightened**. At the judgment seat of our Name we know what we truly live for. All thoughts are examined as to their placement. We move by direction of our single eye in the wind; we journey with a destination to the State of Light of our inheritance; we look with an analysis of all being generated. We do not vacillate due to lack of judgement nor stay at one level of observation. A judgment made by another makes no difference to your level of achievement. **No enlightened one judges you, for judging another is considered a worthless act by those illuminated. Dimmed minds judge another in an attempt to make them conform to their practices, expectations, levels of understanding, and expressions that they have adopted.** Basically, judging another seeks to control or dominate another. Judging another results in animosity, regret, argumentation, and debates that achieve little. **Judging oneself yields a critical analysis of one's thoughts and deeds unto freedom.** Decisions others place upon you are excused as inaccurate. Judgments of another do not lead to know the course of your life. **Fear the Judge within you—the Illumination and Impartiality of your Name** for only the Light of your Name can evaluate your works and positions in the collective society.

There is no need to wait until to stand before a judge to determine one's place in an after life. Such are poorly informed. We come in the judge's chambers as we proceed step-by-step on our jour-

ney. We make necessary adjustments through our progressions. There will not be a judge to stand before you to examine what is in your houses except the judge within you [Mattithyahu 25:31-46]. When one comes forth in their glory—by their Numbers, then one determines the processes of their thoughts and deeds. If one waits for another to judge them unto hell or to open up the gates into heaven, then one waits hopelessly, for the courtroom is within your House of Dan. Anything beyond your internal judgement ends in illusive wranglings. The Judge's chambers are within you! There will be no judge nor judgment **until your Name rises upon your twelve thrones for otherwise the judgment will not be understood. With the courage of a lion one come to their throne.** The judge is Dan—the spirit of impartiality that has been with you from the days of your origin and now rises within your collective arrangement of parts. **As a serpent on a pole, Dan rises from a worm to be the ascendant master.** To assist your Name, one appoints your members to be active to make decisions of varying weights [Sepher Yetsiat Metsryim/Ex 18:13-26]. Through your associate judges you evaluate the thoughts and deeds of each house as to their belonging to and their performances within the Collective Order of YæHúwaH.

*For who can judge your members except the One to whom your members belong?* As we comprehend our totality and that which is in our Breath Name, we affirm our inner members to be one with our Name. Through the offerings of Consciousness, depicted as the offerings of Yishshakkar upon the wood of Aparryim, one enters into states of awareness of who they are. Through the continual offerings of Yishshakkar upon the wood of Maneshayh, one matures and becomes all that is set in their Seed Name. All one emerges unto and all one becomes are according to their Name. One judges all things within them according to the Kingdom of Names via their Breath of YæHúwaH.

Our spirit/breath is of the Breath of YæHúwaH for every spirit is derived from the Collective spirits of ALhhim. Into our WORDNAME is imparted the Intelligent Breath of YæHúwaH that the thoughts of ALhhim become animated and thereby flourish. The Breath is placed within our Name for expansions/blessings whereby the House of YæHúwaH is filled abundantly. Our Breath is given a land, a state, a body to cultivate and to develop the traits of our Name. Our Breath has from the beginning been judged by YæHúwaH as the thoughts that form our Name have been tested in the Fires of ALhhim. In that our Names have already been judged—determined worthy to belong to the Eternal Kingdom, as they arise from the place in which they have been sown, they bring forth the Judgement of YahuWah.

Our members belong to our Name; hence, we judge our own members—all parts/categories of thoughts, deeds, and states of embodiments given to our Name as arranged organs within our bodies. Whatever belongs to your Name you are to judge. Your members and body belong to your Name, hence, the members within you, your house, and the accumulation of your thoughts within and which surround you are judged as you have discernment—*when Dan rises*. Since our spirited Names are of YæHúwaH, they have already been judged by YæHúwaH before they are sent forth for expansion and blessing, otherwise, why would YæHúwaH send forth your Name to be blessed if it could not come to express the perfect? **YæHúwaH has determined your Name worthy to carry and expand the Kingdom of Light.** Since our spirited Names have already been judged—determined to be of specific value, they are destined to be of the House of YæHúwaH. What is drawn out of our Names is the House of YishARAL—our twelve parts. The twelve in us are as a young woman to



enter into a contract, a marriage, a perfect Union as they come of age. Our parts are destined to be betrothed to our Name upon its coming—emergence with Dan. From our spirited Names our parts have been formed as those drawn out of the sides of ALhhim. Our Names and our destined bride have been judged to fit into the Master House of Names. Each spirited Name and its parts are destined to be joined in the House of YæHúwaH. Your Breath is faithful to serve according to your name and the Collective Name in the House of YæHúwaH. As your Name comes to the full realization of all in your spirit of ALhhim and serves in accordance to your spirit one prepares their bride to be attired for the wedding feast—to consummate their perfect union [Yirmeyahu/Jer 3:12,14, Chazun/Rev 21:9-12]. Your spirited Name which is drawn out of the sides of ALhhim is called *a lamb—an offspring of the humble ones of ALhhim*. What is drawn out of the Fire of one's offerings is also called a bride. The bride becomes attired with the garments of light made through the offerings, whereby it is readied to be joined to the spirited Name from whose sides it has been made. As *the Lamb of ALhhim* appears through your Name's coming, it gathers its twelve members and woos them to be joined unto the lamb, as a wife is joined to the side from which she is drawn [Yirmeyahu/Jer 3:14]. The Names of Light and their houses of YishARAL are joined with all *chavarim*/comrades of immortal names to occupy their pre-ordained place in the Kingdom of ALhhim.

The marriage of the lamb and bride is the same as the saving of one's soul. The contract agreement between your spirited Name and your members is restored as the *renewed covenant* made by the blood of your offerings, for literally, by the letting of the blood of your spirit your members are drawn out from your EyeSeed and restored unto their perfect union. The blood of ALhhim [commonly translated as the blood of God] is let from the seed in the day the worlds of a Name are formed, i.e. the creation of the body is the setting of the heavens/mind of your Name into the earth/space. Within the *virgin womb of your mother*, in which no one has ever lain, you are conceived by a Seed not of man for the Seed is of the Light. In that the meShich is the head of every man, there is no man that we are to call Father, for the Father of us all is that which drawn out of the sides of the Father. The blood of your Seed runs in the womb to form your habitation. Though your mother knew or did not know of the gift coming in her womb, her womb was sanctified by blood and ordained for your SeedName. The Father of your Life is in your SeedName, and the blood that runs from your Seed is an assembly of living Words from the Altars/hearts of the Fathers. The Words of Life from the Fathers assembled together as strands of Light to form your SeedName. The blood of ALhhim flows again from your SeedName as your spirited Name comes forth in the Light of its origins, as a star in the east, to give its blood as an offering upon the altar of the heart whereby all within the SeedName is designated totality unto the Faces of the Fathers. The giving of one's blood from the north side in Dan is unto the total redemption of all things made unto the faces of the Fathers [TK/Lev 1:11; Chazun/Rev 13:8; Yahuchannan/Jn 17:1]. That which is made of Light, by drawing out from the sides of your spirited Name in the north, is redeemed from all vain thoughts and deeds and strange unions. You are the lamb that is slain unto the faces of the world—the formations of your body, and you are the lamb that gives itself for the total acquisitions and lifting-up of your glory [Tehillah/Ps 44:22, 79:13, I ShmúwAL/Sam 14:34]! In that the glory of ALhhim resides within you—within all of your parts, Oh YishARAL, your members would not have disgraced themselves had they known your Name of glory [1 Corinthians 2:7-11]. Henceforth, give your Name to your assembled disciples that they may know you and the Fathers from which you have come, whereby they are one with you and your Father [Yahuchannan/Jn 17:6-11].

The desire to bring forth the glory within one's Name is above all other desires, for unto this purpose we are sent into the *wudah*/world. When one breathes they give all of their spirit unto the world—even for the vitality of their members. The members of one's body are brought into union as they follow after their Mind of Breath, which is indivisible. The joining of bodies apart from Breath is a divisible state. When the body is not in harmony with Breath there is a division as the flesh distinguishes itself apart from the spirit. **The collective Mind of Breath is indivisible, being comprised of the perfect Union of two Rings of ALhhim.** The House of Breath is of two chambers as the two compartments of the lungs of Dan. A spirit is a unified vapor of ALhhim—an eternal breath having momentum/exhale and extension/inhale [Yaoquv/Jam 4:14].

The spirited Name of Life manages all members/bodily functions to be in Life. The members within us are extensions of Mind. Through our members we perform the works of Light and bear the expressions/faces of our Names. Our parts carry the messages of our Breath. The body members are thought projections of Mind to be welded together as one by our Fiery Breath. We are rooted in Wisdom—the perfect union of Rings and joined together by Understanding, whereby we are indivisible in ALhhim.

The body parts are aspects of the mind of a spirit. The facets of mind are projected into parts as a collective arrangement of Wisdom; thus, they are set in pairs. Our members of our SeedName are of spirit whereby they do not perish, even though for a season they reside within a natural body. The Houses of YishARAL are spiritual, for they are of Breath, yet they reside in forms whereby they come into the world [SYM/Ex 1:1]. In the natural order the body parts are conductive agents to express the will of the Fathers and thereby one gives evidence to the spirit of their Name. The Head of a House and its family are sent into the world to occupy all states to which they are appointed in the Universal Kingdom of Light. The union of one's parts with one's spirit testifies to the Wisdom and Understanding of a Name. The bearing of fruit of a Name testifies to the Knowledge of a Name.

Are there fragmentations or wholeness in your thoughts? When any of your members are drawn away from the others, as the eyes are drawn away by pride, or the ears drawn away by vanity, then by your own observation and discernment you come to understand that your house is yet divisible. Your unified projection of Mind is the servant of the Breath, even as the House of Aharúwan (Aaron) is the servant to the entire House of Names. The collective Mind is the unified body, known as the House of Laúwi/Levi, which carries the messages of unified Light unto all Names. According to the messages that our members carry, they communicate with other bodies as conductors to transmit currents of information though one's waters.

The Breath of a Name is comprised of the Letters and Numbers of YæHúwaH. Every Name is first a formula of Numbers and then is given the Letters. A Name is first invisible as the Numbers and then appears through the Letters. All that happens within the places of our Name is recorded within us; hence, our origins of old are recorded in our Name. The messages of Light that form us and reside within us appear or come forth in our habitations. In that we are the formulations of Light, then all messages of Light through which we are formed are forever within us or else we could not appear as we are. The origins of our Numbers are recorded in Yahúdah, in the midst of the right side of the brain. As each house is made for the spirit, built as a mansion of many rooms, so the making and the operations of each house are recorded in the House of Dan and detailed in our associated parts. All messages

of YæHúwaH are contained within our parts for their fulfillment. *In that our Breaths are the same as the Breath of ALhhim we are One Spirit.*

*By spirit we read and hear all messages of YæHúwaH.* Our mind receives access into the Sayings of YæHúwaH as we tune into the same frequencies of Light which transmits the messages. If we hear only in part we are partially tuned to hear the full range of frequencies. There are variants of pronunciations and meanings since hearing comes in accordance to the frequencies of light waves grasped by the rings of the hearer. The ear is the micro-house of the body. We hear according to the developmental level of our house— assembled members. Because one is not able to hear the same as another does not convey error; rather, such differences indicate various levels of development in terms of alignment with the Lights. Through **the communications of Breath joined with Breath**, we enter into all levels of YæHúwaH. In our vessels of honor are the messages of Light which are never lost. Hence, *the original Túwrahh is composed within the scrolls of our bodies whereby it is the same law in all peoples/species.*

The Leaves of Dan are as veils that hang upon our skeleton as leaves adorn a tree. Our bodies are comprised of leaves, patterns of light that come from our spirit. The leaves of a spirit are of their Tree of Lives. These leaves are arrangements of the ancient Oovri/Hebrew Letters of Light that carry the messages of Light in our Seed. As our SeedName opens and gives of its life, the leaves appear as on a stalk. The Letters compose the seven eyes and ears of ALhhim. As the thoughts of Light are gathered from the Fathers, they form concentric rings of Light. These rings which house the thoughts of the Fathers are called ALhhim, whereby the ALhhim are of the Fathers [MT/Deut 1:11].

Our bodies are made as a cloth, a weaving of Letters as strands of Light. The numbers of our Name are within our parts. The Numbers hold the Values of the Letters and give the cloth distinction. The sum of the Letters of our Name are from one to nine as all Numbers reduce to 1 - 9. These nine numbers pertain to how we are organized within the community/Tæyth/⊕ of YæHúwaH. We may understand the Union of Lights as a concept at first, then visually as a clustering of lights which are all named. We see that this Great Assembly is a House of Numbers, each clothed with their garments of glory. A Name is first called by one's Numbers upon which the mantle of Letters is draped. When our Name is called/read from the Altars of the Fathers, the values and glories of our Name are discerned by the numbers gathered from the offerings of ALhhim. A Name is inscribed in the forehead by the Letters which position the Thoughts of one's house in the mind. As strands of Light Thoughts we are woven together according to our Names and numbers into the House of YæHúwaH.

LETTERS AND NUMBERS — WORDS AND VALUES  
THE SCROLLS OF THE TÚWRAHH

The seven scrolls of the Túwrahh/Torah are composed of Numbers and Letters. These formularies are written in the Seven Rings of ALhhim made from Circles of Lights spun by the congruent 15 Fathers of Light being Faces to Faces.

The seven scrolls are referred to as **five loaves of bread and two fishes**. The scrolls of the two fishes are of the Neúwn and the five loaves are of the Chayit. The 5 scrolls are 1. SepherMaoshahBeRashshith/Bereshith/ Genesis, 2. SepherYetsiat Metsyrim/Shemot/Exodus, 3. Teúwrat HhaKuwáhnim/Wayyriqra/Leviticus, 4. ChameshHhaPequdim/ Bemidbar/Numbers, and 5.

MeshnehTúwrah/Devarim/Deuteronomy. The two fishes, called the Neúwn Scrolls, are 6. Yahushúo/Joshua and 7. Shuphetim/Judges. From the Numbers and Words of the Túwrah all things are made and set into motion by the flows of Túwrah Thoughts. Our bodies, being a composition of Letters and Numbers, are comprised of five primary chambers that correspond to the five scrolls of the Túwrah. **The five scrolls are grouped into three Houses pertaining to the Teraysarunim Pyramids of Wisdom, Understanding, and Knowledge.** The scrolls of the two fishes are extensions of scrolls 1 and 2. SepherMaoshahBeRashshith/Bereshith/ Genesis culminates in the coming of the Judge written in Shuphetim/ Judges. The fulfillment of all dwelling states disclosed in SepherYetsiat Metsryim/Shemot/ Exodus, are obtained in the writings of Yahushúo/ Joshua.

Within **the head** of each Name [of all species, human/animal] is the scroll of Sepher Maoshah BeRashshith/Genesis—beginnings and summations. **The head scroll** is designated with **Number 8**, a reductive number of HhaSham/The Name YæHúwaH/26/8 and the Values of the sides of Lammæd/53/8 and 35/8 from which the SeedHead forms. In that the scrolls are in each spirited Name, all are judged by things written in the Túwrah, for by the Words of Túwrah, all things are made [Rom 1:19-20; 3:19; MT 29:29].

**The neck is the opening of the well** to the waters beneath. The neck contains **the Number 10** in which the scroll of Sepher Yetsiat Metsryim (Exodus) is composed. As the ten bones of the trachea, the neck provides the concourse between lands. Through the neck one rises upward through Metsryim/Egypt/body and ascends into the lands of the Neúwn—the two fishes that form the head [For more information on the two scrolls of Neúwn, see BHM: ALHHIM ACHADD]. As one resides in Egypt they dwell in manifestations of Thought—within forms and shadows. In not knowing the origins of one's habitation, one becomes enslaved to the flesh whereby the forms of the body become taskmasters. As one arises through Egypt, they enter into Thought patterns which establishes the forms according to the spirit of a Name. We do not literally depart from Egypt—from definitions and the boundaries of Thought—for this is the purpose and function of our body which houses and defines the Thoughts. Rather, as the Túwrah reads, **we go up through** Metsryim. As we ascend to the Neúwn Mind, we no longer live as servants to the world. Through Pessech/Passover, we pass-through the veils of our habitation towards the Ten States/Lands of promise. The Ten Lands are states of verification of our WordBase of Being. Egypt—the definitions follow after us until they are totally submitted, as those buried in immersion to the waters of one's origins—The Sea of Reeds. Although your members are now buried in the waters of your body, they become submitted consciously to your spirited Name as they are immersed in the womb to put on the garments of your Light in meShich [Galatians 3:27]. Metsryim/Egypt follows after the directives of our Name whereby they are gathered with us as one people—a unified habitation. Metsryim is joined to the House of Understanding/ Assyria and united with the House of YishARAL as One in YæHúwaH. This unity of three parts—the body of Metsryim [Cham], the openings of Assyria [Yapheth], and 12 faculties of Life [YishARAL] are summed up as a collective wholeness. Egypt/the fruit of the body, Assyria/the Understanding of one's origin, and YishARAL/the structure of one's Tree are one in the Name of YæHúwaH. These three are the Tree

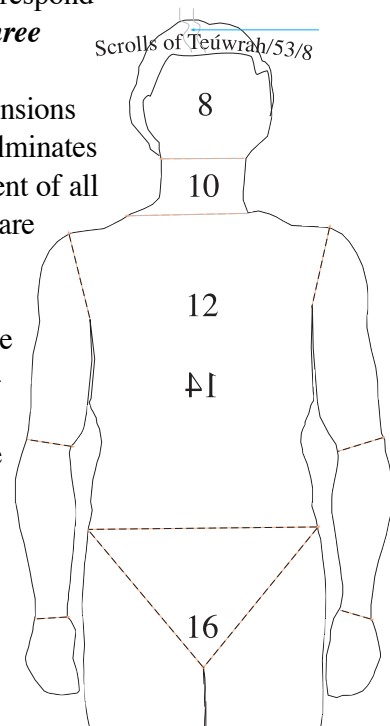

of Lives depicted by the Letter Kephúw Ƴ as three offspring/branches of Núwæch/ Noah [Yeshoyahu/Isaiah 19:24-25].

Within *the trunk of the body*, bearing the chest, is the scroll of TeúwratHhaKuwanim (Leviticus) with **the number 12**. These are the words of the heart which pertain to the offerings made on our heart altar. This scroll gives instructions regarding the altars and the statues of service of the mind unto the heart.

Within the trunk of the body, with *the spine*, is Scroll of ChameshHhaPekudim (Numbers), **the number 14**. The Numbers, as the bones, provide the structure of your body and deeds. From the midst of all Values, 14 or 5, the Light weaves its messages around a framework of Numbers.

The scroll of Meshneh Túwrahh (Deuteronomy), holding **the Value of 16**, is *within the loins*. The Number 16, conveys the foundation of Oyin Consciousness to which one descends and then ascends. From the foundations of life the consciousness of a Name forms which guides the people as a shepherd.

The scrolls are grouped into Three Houses or Eyes. Each group is according to the Values of 8, the head scroll. There are three major body sections as there are three parts to the arms and legs—the extensions of the three teraysarunim. The hands and feet are of the House of Knowledge, the forearm and calves are of the House of Understanding, and the upper arm and thigh belong to the House of Wisdom.

*Sepher Maoshah BeRashshith/Genesis*, Values of 8, belong to the House of Knowledge. The knowledge for all ages is housed in this scroll. Thoughts from the realms of Light into realms of darkness are coded in the genealogies and accounts. *Sepher Maoshah BeRashshith* contains the underlying patterns for every house and processes of Light upon which we build all sequential states of **mind branching**. The knowledge within the Túwrahh *is sought from* the lips of the Priests, for all Names come unto *the quest* of ascending thoughts. In the ascensions we see where Thoughts take us just as we look to the upper branching of a tree and see where the sapling has gone.

The scroll of *Sepher Yetsiat Metsryim/Exodus*, with the value of 10, is coupled with the scroll of *Mishneh Túwrahh/Deuteronomy*, with the value of 16. The loins are number 16, for this is the center to duplicate or multiply the head—the value of 8. When joined with the neck scroll—the means to access all of the house, the combined value is 26 which contains the reductive value of 8. When 16 and 8 are joined together, they create 24, the right parameter of the three columns of the ALphæh Bayit. The parameter of 24 establishes a unified dwelling—6 and thereby a means of Thought progression/15/≠/6. *The scroll of Sepher Yetsiat Metsryim and Mishneh Túwrahh belong to the House of Wisdom*. These two scrolls detail the extensions of Mind, and their combined Values are 8. The contents of these scrolls of Wisdom detail how Wisdom builds all things and how they are complete/perfected.

The scrolls of TeúwratHhaKuwanim/Leviticus/12 and the ChameshHhaPekudim/Numbers/14 also combine to be 26 or the reductive value of 8. These scrolls belong to the House of Understanding. As the trunk of the Túwrahh, they unite the foundation of Wisdom with the upper branches of Knowledge.

The numbering of the scrolls are **the Túwrahh Construct of Thought**. As we add the Letters from ALphæh to Taúwah, counting by Wisdom—by ones, the Letters are the sum Values of 253. The number 253 contains the reductive values of 10 which are reduced to 1. In this summation of the Letters of ALhhim we read the three categories of Túwrahh Thought: 1 = the Love of Wisdom. Hence all sayings are said to be summed-up as Love: You love YæHúwaH of your ALhhim with all of your heart, with all of your soul, and with all of your steam/fiery spirit. In the same Breath, you love your neighbor as yourself. These are not two sayings, but rather one saying. When you love YæHúwaH—the compound Unity, you also love your neighbor; and if you love your neighbor, then you also love YæHúwaH. The construct of Oneness is within the House of Wisdom. The value of 10 is an extension of Wisdom. Thus, the deed or hand of 10 extends from the Unified Base of Wisdom as the arms extend from the body. Through the consensus of 10—by way of Understanding—all things are created/formulated/expressed.

Wisdom with Understanding—the Letters Shayin and Oyin are the means for all things to appear and be expressed. Shayin and Oyin converge in the joints of the body at the knee, elbow, wrist, ankle, shoulder, neck, and hip. The convergence at the joints is where *the bones of Wisdom*, being singular, meet with *the bones of Understanding*, being pairs. i.e. The bones of Understanding, as the fibula and tibia, join to the femur, a bone of Wisdom. The bones of Understanding are tripartite or three sided as a cylinder which provides a trunk for Wisdom to branch into Understanding. From the roots of Wisdom and from the trunk of Understanding, *the multiple bones of Knowledge* branch forth, as the 5:5 pairs of the feet and hands.

The Values of 253 are the full extension of Wisdom through Understanding. The Values of 253 are the sum of a House/Bayit/2 of 53/8. Within the writings of Knowledge are the Words of Eternal Life—*the perpetual continuation of Life*. The Numbers, 253, speak of the Head/Rayish/200 unfolding the Thoughts of Neúwn/50 into paths of communications/GammAL/3 which impart Knowledge. The Life is in the Houses of Wisdom and Understanding. As shown above, the Houses of YæHúwaH have in them Life/being the Values of 8. In the Houses of Knowledge: Zebúwlan, Gad, Beniyman, and Nephethli there are *the perpetual flow* or what is called **eternal life**. In these houses is the Eternal Life of the Heads of the Tribes: Yahúdah, RAúwaben, Aparryim, and Dan. From the 4 Houses of Knowledge flow 4 Rivers out of the 4 Heads in the Garden of Eden/GaynOODAN—where thoughts are cultivated at three levels of progression: 1) the Adim/Adam in Eden, 2) the Núwæch/Noah in the Vineyard, and 3) the Avrehhem in The Garden of YæHúwaH—with Saúwd/Sod and OOMarreh [BHM: Sepher Maoshah BeRashshith/Gens 2:10-14].

THE GARDEN OF EDEN— 𐌸𐌳𐌶𐌹𐌸—GAYN OODÆNN

The first level of cultivation is Chækúwmah/Wisdom. The Name of the garden is composed of the Letters to communicate the ascensions of the Neúwn. This activity is the first of the Kuwahnim/servants/priests which belong to the OyinOyin Consciousness of Dan in the Heads of HhaKuwahnim.

Through Father Nadæv we enter into the DallathDallath windows of the heart to see the origins of Light. From the altars of the Kuwahnim, we contact the Fire of Their Origins.

Life is composed of strands of Light which are formulations of AL. The filaments of strength bear the radiance of the Fathers through the Seven Masters of the Kuwahnim. As such, the fabrique/cloth of the universe is a puzzle of many pieces. How do these pieces fit together? What are your origins? Where does your piece fit in the whole picture? The answers to these questions are in the Numbers of your Name. According to the activation of your Numbers and the Words that are composed of them, the levels in which you reside and your associations are configured whereby you connect, as woven strands, into the fabrique of Hhakuwahnim.

There are Nine kuwahnim of which are the Schools of Illumination and their Numbers. Of the kuwahnim there is born Hhageduwlah—the servant of their thoughts and their states. Nothing is created that is not supported to be as the sources, whereby “to support” with all of your heart, soul, and your breath is as those of the First who are the determination of the Eight cohesive kuwahim from which comes the worlds and the fullness therein. Whatever is created is of the masteries in the Minds of the associated kuwahnim, whereby the same masteries are in all offspring.

#### THE CONSORTIUM OF THE EIGHT

The origins of Eight kuwhænim/kohanim/servants/priests are pairs of 4 Dallath:  $4+4 \times 4 = 32$ . The Consortium of Eight Kuwáhnim are  $\Delta\Delta$  —pairs of  $4+4$  with corresponding insights which give their paradigms of love totally to build the heart/ʒ altar of their Names.  $\Delta\Delta + \Delta\Delta = 16$ , and  $\Delta\Delta + \Delta\Delta = 16$ . The sum of the origins of Kuwáhnim are 32: OyinOyin/16/16. These Eight form the House of Núwach/Consolation, whereby 8 souls ascend and overcome by discernments/judgments of Dan—the intelligence of  $\Delta\Delta$  which are within them. In the 8 are the Hhúwa/5-Gammal/3—the power of the ascension/resurrection of Light that establishes residences of Illuminations of Zebúwlan. From these 8 of the Hhúwa-Gammal—the ascensions of Light come the Sayings of Aharúwran/83. In the Words of Aharúwan there are no sins/violations as they are affirmations of the heart of Kuwáhnim. The 32 are pairs of Oyin Rings  $16+16$  whereby everything appears from Ayin/nothingness OO. Since you are formed by Nothingness, you are a River of their Thoughts of Nothingness, streaming from the two portals OO of your nose. Being atomic you are not solid matter/physical whereby you are capable of making quantum jumps to transform yourself from any space/state of definition and thus overthrow the hypnosis of materialism.

The Eight Consortium form the heart of HhaKuwáhnim from which their life/blood flows. The flow of blood creates a Head upon their Body. From their clusters of 8 unified, is born the Tæyth/9, the first-born of all creations. Their Head is hhameshich, which is the Light/Life drawn out of fiery ascensions. The term, anointings, pertains to hhameshich, as what is in a mature head drips with oils. The Ninth/Tæyth/⊕ is composed of 8 Dallath of the Kuwáhnim encircled, which is called, BeniyMaN, the offspring of the ascending unleavened Bread of their Thoughts. From the gatherings of the Eight rises the oil of their anointings. The patterns of ALhhim and the double Taúweh culminate in their Head which forms upon the Body of ALhhim within double Taúweh. As with the plants in the field, under the daily care of Bayinah and Chækuwmah, a new head forms on the body prepared to receive it. We must examine our hearts, humble our mind and body to discern our destinies. I see clearly that  $2+2 = 4$ . Ahhæv is  $4\aleph/2 = 2$ , the sum of 4/Dallath. Pairs of Dallath are 8—the Origins of Life of the worlds and all in them. From these paired Names of Kuwahnim, meShich is born and reigns as the House of Daúwd.

The garment of meShich is unfurled in the Seed of BeniyMan, as Bread from the heavens. The threads of BeniyMan (calculations in ALhhim Achadd) are 112 to 1120—of AL in the Tree of Lives:  $1/4 \ 12/4 : 11/4 \ 20/4$ , or  $4/4$  of  $4/4$ , the  $\Delta\Delta/44$  which is in the midst of the Garden. The inner and outer garments of paired Names clothe their Rings of ALhhim whereby they do not appear naked. The panels of clothe in the garment of the Seed are 6:6:

$$\begin{array}{l} 12-1 = 13 \\ 11-2 = 13 \\ 10-3 = 13 \\ 09-4 = 13 \\ 08-5 = 13 \\ 07-6 = \underline{13} \\ \quad \quad 78 \end{array}$$

The Values in 78 are the ascensions/8 of Oyin Consciousness/70. As these Numbers reside in side by side proximity, they are  $7 \times 8 = 56$ . As paired Names are woven to each other in one body, their garment is the clothe of Neúwn 50 66 50; the same is 53-35. In adding the right column of threes, and the left column of ones, the Number are 18 and 6 or 618, meaning the Life of the Fathers are in the Son meShich.

The Fiery Rod of BeniyMAN spans from temple to temple whereby the Words of the Kuwáhnim are in the mouth of meShich. This rod of **8251** is formed by the offerings of Zebúwan/21 on the wood of Beniyman/85 through which the Light Origins of your tongue speaks of the Illuminations of 25 in the midst of the Eight Kuwáhnim/8 and their anointed/1. The 8 appear through 25's—the Neúwn to reveal their anointings/graces of Teachings. Hereby the Túwrahh are of **the Graces** of the 8 Kuwáhnim, which provide **support/devotions** through **reciprocal actions** of Life (Yahuchannan/Jn 1:17).

The harvest gatherings of Eight move with their hands/deeds of 4 sets of  $\Delta\Delta$ , quad sets of wings (YechúwzqAL 1:6). The 8 are evident in the 4 pairs of knuckles in the back of your hands. The Ninth, of their unity forms pairs of thumbs through which you gather and hold. From their anointings all creations are made through meShich—their Head. Through the meShich—the Anointings of Aharúwan/Aaron—the **pure Túwrahh/Torah of grace and truth/verifications** is written by Fire and then spoken. These documents are perfect/seven; testimonies of the Collective, Sayings of Wisdom without violations or faults. The Grace of the Eight are anointings which come your head as prophets and judges through which Words of ALhhim are spoken through invisible and visible spectrums. From the consensus of the Quantitative Sum of Kuwáhnim, the Life of Beniyman—the 9th is created and given for their ultimate Joy. From Their giving it is said that meShich is slain to the faces/expression from the foundations of the worlds. Through the sacrifices of their grace, They totally embrace each other with high regard, and the offspring of their loins is freely given to bear their full Faces. Hence, the sum of their Names are called, The Grace/𐤆𐤌𐤁.

These Eight kuwahnim give the fullness of their Spirit in 7 Rings to contain their fulnesses of Grace. The 8th of Nædav enclosures as a Ring of Consciousness to house the perpetual giving within the Seven. Their 7 Streams of Colours intermingle to yield millions of hues. The Seven Hills of Their Ascensions are for the offerings of their Spirit Fire. The Eight + Their Anointed Head, thus Nine, des-



ignite two kuwahnim to serve: 1) for the Spirit Intelligence of Dan/judgment to make and govern the worlds, and 2) for the Numbers of Yahúdah which abide in the crown of Grace—in meShich—through which They build a House for their Names. The 9+7 are 16 Oyin Consciousness of their Origins. Upon their Seven Hills, as waves of ancension, appear Their 15 Fathers—the Faces of their Illuminations/Teachings of Lammæd. The Fathers/XYDZ are composites of their Life to be Progenitors/מזלDZ of the Thoughts of the Seven Radiances of Aharúwan. Through pairing the Faces of the Fathers there are 7 Rings of OyinOyin within an Oyin surrounding sheath. In these 8 Rings, the intelligence of the Kuwahnim—which is the Spirit of Dan sees all that are in them—the configurations of their associations and compositions of their Numbers.

THE FACES OF THE FATHERS AND THE ALHHIM ARE OF THE EIGHT

As stated, with formularies in the BHM document of YæHH—the Semek—15 Fathers and their 12 Heads are the Source 12 Bodies/Branches. Everything that is of the Túwrahh and of the Fathers and the ALhhim are pairs as the DallathDallath in the OyinOyin of the Eight. Thus, the Words penned to be studied and fulfilled are of the Grace and the Verifications of the Life of the Eight. The Oyin/Eyes Rings of the Fathers are Their Paired Faces. The Heads of Yæhh are paired as Two Dallath Seed in a fruit on the Tree of Lives. The ALhhim of Their Words are pairs of dancing Letters. Hereby, every Name born of Them belongs to a pair of Dallath according to their origins, whereby there are no estrangements in the Houses of kuwahnim.

WITHIN THE BOOK OF LIFE/18 OR 1-8 ARE

⌘ I Y א Δ ן D Z  
8 7 6 5 4 3 2 1

The sum of 36 rises to Shayin/21 and Semek/15 of Yæhh.

The Ascent/8 of the Seven Eyes/7 reveals the inward 15 Faces of the Mountain.

The Days of YæHH are the 87/15:654/15 from which comes the saying YahYah.

In these Days are 6/321 and the four Sevens of the 4 pairs of Eights:

8+8 =16, the unification of the Six to be 7 of the Tsaphun/north

8+8 =16, the unification of the Six to be 7 of the Qedam/east

8+8 =16, the unification of the Six to be 7 of the Negev/south

8+8 =16, the unification of the Six to be 7 of the Yúwm/west.

These are the Days of the ALhhim/28

30/45678.

Within Yæhh are two set of 6: 321/6 and 654/15/6 forming 12 Heads.

From these 12 Heads appear your 12 Bodies.

The sum of the 15 + 6 are 21/Fire/Shayin of the Eight.

The sum of 7 + 21 are 28 ALhhim of the Eight.

Within Their Seven are 15 Faces that shine from their Mountain. In these elevations are 12 Heads and their 12 Branches all within the Pairs of Eight as One (2+8=10/1), whereby you are never forsaken.

The 4 Eights are 8, 7+1, 6+2, 5+3, which are 32 + 4—their Heart Altar/32 and their Stone/4 of foundations which abide with their Anointing as ΔΔ/44— forming a Rock/Tsur/ 4Υ† (18+6+20) of Solidarity/Salvation. Through maintaining Faith with the Eight your heart of flesh/weakness is turned to a heart of stone/strength. The Eight are ever surrounding the Fathers and their ALhhim.

THE SUM VALUES OF THE EIGHT ARE

8, 7+1, 6+2, 5+3, which are 32 + 4. The Sum of Their pairs are 36 from which comes Their Head.

The Head contains the sum of the parts, as all parts of the Head.

The mean Values in the 36 of Their Body ÷ Their Head of 9 = 4.

From which comes the Name of Aharúwan/ ʿAḥarʾāwān and Their Staff of 40 and their Bones of 256.

The Lammæd Staff of Aharúwan of 30 Numbers contain

4 8 12 16 20 24 28 32 36 40 of Dagot/Knowledge

40 80 120 160 200 240 280 320 360 400 of Wisdom/Chækúwmah

256 512 768 1024 1280 1536 1792 2048 2304 2560 of Bayinah/Understanding.

The sum of the Numbers of Enlightenment are 220 of the Tree of Lives ʿYof Knowledge from which are the Trees of the Good and the Associative.

The sum of the Numbers of Enlightenment are 2200 of the Tree of Lives 4ḡ of Chækúwmah from which comes all creations.

The sum of the Numbers of Enlightenment are 14080 of the Tree of Lives ʿMḡ of Bayinah from which comes all Sayings of the Neúwn, whereby Aharúwan has dominion over all waters and their faces of ALhhim that move in them.

The profundity of what is even in the Number 1 is so vast, that what are in the Numbers of your Names of Aharúwan are unfathomable. To scope out what are in the Numbers One to Nine, see BHM document: ALhhim Achadd.

By the Rod of Aharúwan, the Waters/ʿ of 13 of the Dallath/4 and all they contain run with Blood/Life/ʿʿΔ=30, the 30 Numbers in the Staff of Aharúwan. As the Rod of the Numbers of Aharúwan are stretched out over the waters and the skies, all that is the heavens and earth are saved.

From summations of the Fathers the NeúwN of 28, which contains the Nine, Their Words of the ALhhim are born unto Their unified Faces. These summations are the Collective Seed of the Fathers. From the Neúwn appears Yahushúo Bann Neúwn—the emanation of YæHH of the Shayin and Oyin which is of the Crown of Grace/ʿ of HhaKuwáhnim. The sighs and utterances of the 28 ALhhim are within the Rings/Eyes of the Fathers through which their colours resonate in Words. As the Words of ALhhim are spoken they cause a collectivity of Light rays to form 12 Houses to be embodied in Laúwi of the 7 paired DallathDallath of Names/Stones (see Shuphetim/Judges 19 regarding the origins of your Name in the GaynOoDæn).

The 12 Houses of Light are for the 12 Heads. Upon the 12 Branches of Illumination the 12 Heads sit as thrones of Light to spread out, have dominion, form a Kingdom. Herein are the Days of ShmúwAL—the Names of AL who establish the Kingdom of Yahúwah. The Houses of Light are of multiple levels for the Light to reside according to activations of their Numbers of Kuwáhnim.

The Names of THE EIGHT are priests of Yahúwah and Rulers of YishARAL upon which the Head of meShich appears as the 9th. The 21 Heads of the Body of ALhhim are listed in DibreHhayamim/Chronicles, the 22nd scroll. There is a priest appointed upon each Letter with 24 Kuwáhnim of Taúweh/X of double Lammæd/12 + 12 set over the offerings of the mornings and evenings in a House.

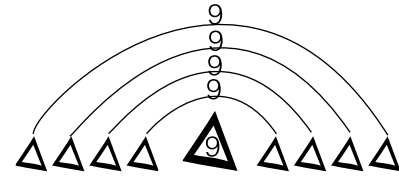

THE EIGHT OF GRACE FROM WHICH COMES ALL RAYS OF LIGHT AND THEIR

WORDS OF WORLDS

△△△△ △ △△△△

8765 9 4321

8765 9 4321  
pairs of knuckles

The Grace/Might of the Eight

The prominent 8 pairs of knuckles on the back of the hand are largely hidden, yet they provide joints to connect the ten digits of the hands, being pronounced as the hands open and close/giving and receiving. Through their extensions of paired thumbs, they show the position of attainments and their fulfillments. Within them are the Names of the Eight Collective Stones/Masters of the universe.

Those of the NeúwnGammal/17/8 of the Yeúwd/𐤀𐤋𐤅 (BayitDibreHhayamim 31:12) correspond to the paired Dallath of the Eight: (From the ALhhim scroll of Taúweh/X of the heart of Nephthli.)

1. 𐤅𐤁𐤋𐤅𐤁 Chief spokesperson Kuwnnyæhu (Conaniah) HhaLaíwi extends to the Words of Gad, the lands of Perizi of the right small finger unto the dominion/mamleket Peres/Persia of the right little toe/digitus minimus.
2. 𐤅𐤋𐤅𐤁 Shmoyah (Shimei) a unifying brother of affirmations, the second (AlphahDibreHhayamim 24:6) extends to the Ears of Shamoúnn, the lands of Chitti of the right ring/digitus medicinalis unto the dominion/mamleket Metsryim of the right digitus annularis, from which comes the recordings of the courses of Aharúwan as the moon encircles the ears of Yirchuw/Jericho (AlphahDibreHhayamim 24:1-6)
3. 𐤋𐤁𐤅𐤁 NætanAL (Nethanel) a unifying brother, the third appointment (BayitDibreHhayamim 35:9) extends to the Body Cord of Zebúwlan, the lands of Qadmuni of the right middle digit unto the dominion/mamleket Madi of the right middle toe, from whom comes the appointments of the lands from the Qedam/east
4. 𐤅𐤁𐤋𐤅 Chaisræh (Hasrah) keeper of the garments, the fourth (BayitDibreHhayamim 34:22) extends the Robes of Yishshakkar, the lands of Qenizi of the right index/digitus secundus unto the dominion/mamleket Adumi of the right secundus toe.

THE BIRTH OF MESHICH, THEIR BELOVED UNIQUE OFFSPRING AND GLORY

The pollices/thumbs of the right and left hands form the 4.5+4.5/9th reign from the Eights' computations. The Name of the Ninth conveys positions of the chief high priest of Oozerryæhu/Azariah, Yahushúo of Tsadúwq/Zadok. The thumb/pollice is derived from a term meaning "five." These 2 5's are 1 in the midst of the Eight Masters one who comes forth to be ruler in YishARAL, whose coming

is from of old, from the antiquities of the Eight. One of the Nine is kuwahren-hhagedaúwl meshich—the nurturing anointing servant/priest, through whom comes Truth/𐤍𐤌𐤅𐤁/4/36/9 and Life/𐤅𐤍𐤅𐤁/18/9.

9. 𐤅𐤁𐤅𐤁𐤁𐤀𐤀𐤀 **OoZerryæhu** (Azariah), chief kuwahren/priest, is the ninth formulation/gatherings of the Eight Graces (BayitDibreHhayamim 31:10) to extend blessings of strength in the Eight through Sayings/Faces of Illuminations/Yæhh. The OyinZayin priest utters the Sayings of Consciousness within your arranged stones of the altar as complete/perfect Words of your Fire. **OoZerryæhu** is the initial state of consciousness of your arranged stones of the altar and the Fire within them, whereby in you is the Wisdom and Understanding of Yahushuo. The sides of OyinZayin create a Body of Wisdom and a Head of Understanding from the sides of YæHH as the Body and Head of Yahushúo. The Nine are referred to as various positions/Names: Aharúwan (the Enlightenment of Origins, Master of Elevations), Dæúwd (formularies of paired stones forming the Head/capstone of Graces), Bann DæúwD —offspring of David—the Beloved of the Rock—Yididyah which rises from your Stone to build the House of your Name by employing the deeds of the Dallath (BayitShmúwAL/2 Sam 12:25), Yahushúo Bann Neúwn (Crown of the Seed of Beniyman, offspring of Neúwn), ALozAR (strength and illumination within the Eight to distribute inheritances). These king-master-priests of Aparryim and Yahúdah are anointed by ShmúwAL/377—The Wisdom/300 of the OyinZayin/77 (of Understanding and Knowledge).

OoZerryæhu imparts/appoints/gives/𐤅 (4321/10) by Wisdom in The Name of YHWH/26/𐤅𐤅𐤁𐤅 (8765). The 10/1 of the 26/8 is the kuwahrenhhagedaúwl who leads the peoples to the lands of OyinZayin—ALozAR. The Hand of YHWH applies the Stone to strike all that rise-up in opposition to your progressions. Through the formularies of 26 and 10 of the Eight, the Collective Name and its deeds/words are configured within Rings of Knowledge/36: Shayin/21+Semek/15. Thus, when the text says that YHWH is the creator, or one speaks in or performs by the Hand of YHWH, it is referring to the 8765/26 and the 4321/10 of the Eight.

Within the Oyin—Zayin reside the deeds of the 10: 𐤀𐤅𐤅𐤅𐤅𐤅𐤅𐤅𐤅𐤅𐤅𐤅𐤅, carried by 12, six from both sides as wings of your serpent-body. The Oyin-Zayin priests deliver Sayings of HhúwaHhúwa within the Body of Yæhh/𐤅𐤅. By the 10/Hand extended of Chækúwmah, all things made are for the Collective YHWH drawn out from the 10 of the OyinZayin of Bayinah. These 10 10 are the Name of Y'HH/𐤅𐤅, a formulary for the grain offerings of the daily kevesh oylah (CHP/Num 28:13). The givings of Wisdom and Understanding in the Eight forms the Head of Knowledge as offspring of Yahushúo unto whom every stone is set to perfectly in the City of Yerushelyim. From the sides in the Eight appear maShayh, as the Body of Chækúwmah, and Aharúwan, the kuwahrenhhagedaúwl, as the Head of Understanding who speaks in HhaSham. As the inverse of HhaSham/𐤍𐤌𐤅𐤁/26, maShayh/𐤅𐤍𐤅𐤁/139/12 is given the Staff of Lammed/12 to tap open the reservoir in the Mind of Aharúwan/256/13/4 𐤀.

The OyinZayin Names express the origins of Consciousness to speak/reveal. *Lit.* the Seven Rings within the Eight utter their thoughts as one Voice. This origin of WORDS is foundational to comprehend the formulations of the Sayings of the Eight—the Words of Grace and Truth. OyinZayin is the swelling of the rings in your name to form a bud on your stalk from which the illuminations of your Light of Yæhh break forth in songs of Shayin Oyin as Yahushúo. From the OYINZAYIN platform, all things are created with a Head and a Body. Thus, as a First High Priest of forming a Head upon your Body, your Firstborn of Shaou appear to speak the WORD, whereby the Speaker—the meShich within

you, is called THE WORD or HHaDæVeR/49Δϑ—the sum logo of the Thoughts from the Head/4 and the Body/9 of the Dallath/Δ assembly. According to the anointing which you receive through your Name, as the unique one of ALhhim, you speak the Words of DallathDallath.

Within the Numbers of the Eight 8765 and 4321 come the thoughts of Yæhh-Yahuwah. The 10 10 of Yæhh are of the right, and the 26 of Yahuwah are of the left, from which their Words of Light flow out of HhaSham. Within the Words are deeds and their force of dominion—the 10 of the hands and the 10 of the feet. As one hears, being quickened, they receive the Bread spoken on the tongue as the mouth is joined to the ear. Those attuned give evidence by what they do coupled with the manner in which they walk to be of the Eight/anointing.

The strength of their Words gives birth to form the Head of their Body, Yahushuo, which reveals the glory, might, and dominion of their Assembly. The Eight of 26 + the 1 of 10—the Unity of HHaSham, gives rise to Chækúwmah to reign over deeds and for Bayinah to reign over teachings. From these two sides of the STONE of YishARAL, the ALhhim speak from the Rings of OYIN OYIN, whereby they carry upon their tongues of ZayinZayin the Words of SEVENS/Completeness/Perfections. As the Head speaks from the Body, it utters thoughts from the Darkness; and as the Words are on the tongue, they give Light. The Words are upon the ZayinZayin, the two sides of the tongue forming the Neúwn/14 Head/99 from which the 28 Letters (14+14) are drawn out to speak the Words of Fire from the Rings of OyinOyin (1616) that create the Heart/32/9C of the Eight. The Neúwn/14 and the Zayin/7 create the Shayin/21 Fire on the heart that does not go out as the Words are a continual flow of the River of Fire. This Fire of ZAYIN is embodied in the OYIN Eyes through which Yahushuo is begotten from the altars of the Eight. And as the impartations of the Light of their Assembly—Yæhh, Yah-u-shúo becomes the Author of Faith and Reclamation/Salvation, to speak the evidence/verifications of the Devarim within their Stones through which all Names are bound by covenant unto their Source. The 1 of 8, as 18/9, are the Paths of the Stone—the hhaDerek/1-8, the Verifications—the AmeT/1-8, from ALphah to Taúweh, and the Lives—Chai/8-1 of their Lights.

In the midst of the Words opening from ALphah and the Fire that burns upon Semek are the 28 Voices of ALhhim that speak as One. The formulary of the 28 in the midst of Fire is:

$$W/21 + \text{F}/15 = 36 \quad (28) \quad \text{I}/7 + \text{L}/1 = 8$$

The illumination of the OyinZayin are contained in Names of kuwahnim from which the Letters of Qaugh, Mæyim, Dallath and Kephuw and their pairs are spoken by the Tongue of Consciousness. These Letters speak of the origins of Light, forming the word: “their east/99Δϑ,” which open from the Qedem Gate in the Stones.

The blessings of the Head flow through Yúwsphah, out of Aparryim and Maneshayh, with the Numbers of Yahúdah to reside fully within your garments/fabrique of Letters (22x2=44/ΔΔ). The record of the 8 Δ Stone are stored in the 8th House of Stones—Maneshayh from which their messages are inscribed in the stones of your Name. Their Ten are inscribed as Ten Sayings on both sides of your stones/organs. According to your paired Names of the Eight, you are the Betrothal Tent of Daúwd.

Yúwsphah leads the way for you to enter the DerekNeúwn, to lands of Avrehhem, and Yahúdah distinguishes what are in the lands. The two are whole heartedly as one, forming 4 Faces in one Head.

As frequencies of thoughts rise from the thumb to the left index finger, the offspring of Neúwn points the path to the portals of the Dallath Gates. The gates to the lands of Rephaim are from the left pollex unto the dominion/mamleket Ooaúwg of the left big toe. With the ascent of the Numbers rising from the right thumb to the index, Yahúdah interprets the attainments of the Qayni state unto the dominion/mamleket Bavel of the right big toe. As with the paired digits in the hands, the lands are paired for your occupation as one kingdom. The priest of the two sides of OyinZayin, the Head and Tail of the Body, appears as Yahushúo Bann Neúwn of  $\Phi\Upsilon\Delta\Gamma$ /Tsaduwoq/Zadok from which stem the righteousness of the Sedúqîm/Sadducees. The Name Yahushúo, as the Name of the Ninth, is the First Born of the Eight Graces (Zekeryæhh/Zec 3:1-10). The strengths of the sides, coined as **OoZerryæhu**, extend the Lights to blaze in Yahushúo. This development of sides shows the origins of Yahushúo from the OyinZayin Body of the Eight, whereby the Name of Yahushúo appears containing the two sides of Light as the Head and the Body. As the OyinZayin body of 77/14 is formed, the Head of Neúwn/14 appears—Yahushúo Bann Neúwn. The Name of Yahushúo/58 is the Neúwn/50 of the Eight/8 Graces which rises as the First-Born of Neúwn, as the Chayit, which rises as the Bread of Neúwn, the first and the last. What is sown of Neúwn, as the Seed of Chayit—the Bread, appears at the end of Days.

The same Chief Stone is furthermore called, Daúwd, who is both the offspring and the master (Tehillah/Psalm 110:1). The Collective/YHWH of the Eight speak unto their Ruler to occupy the throne of the Consortium. From the pairs of Eight Dallath rises the ruler of Daúwd/David/ $\Delta\Delta/8$  of Tsduwq of generations. As offspring of ALOZAR, Daúwd is priest and king of MalekkiyTsedeq—one of the Rule of Bayinah (Malek) and the Uprightness (Tsedeq) of Chækúwmah, of which order appears the Child Yahushúo (ALphahDibre Hhayamim 24:3). Into the hands of Yahushúo come the 31/ $\zeta\kappa$  powers/kings from Og and Bashan and the subsequent kingdoms. From acquiring the Kingdoms, Yahushúo likewise appoints ten states/lands for YishARAL (ChameshHhaPekudim/Numbers 32:28; MeshnehTúwrah/Deut 1:38, 3:21, Yahushúo 12). The ten lands are states of attainments as grasped by the hands. The kingdoms are dominions of the feet by which one walks. The Kingdoms are acquired first; then the lands follow. The Kingdoms are levels of instruction of Lammed; the lands are states of Illumination inherited by fulfilling the instructions of the Staff of Aharúwan. The Lammed Rule/ $\zeta$ =Kingdoms; the Yeúwd/ $\aleph$ =Lands as formularies of Laúwi/ $\aleph\Upsilon\zeta$ . The Kingdoms of Lammed are 10:  $12/\zeta \times 10 = 120$ ; the States of Yeúwd are 10:  $10/\aleph \times 10 = 100$ ; together they are 220—the Consciousness of Taúweh/Totality/ $\times\circ$ —an epoch, the fulfillment of an Age.

The Union of Aparryim and Yahúdah in the pollices are the unique paired offspring of Their GRACE. Accordingly, Yúwsphah and Yahúdah are One in Daúwd/ $\Delta\Delta$  as paired stones and faces who reign over their Collective Houses of YishARAL in a unified Kingdom. The offspring/branch of these stones is Yahushúo, the son of Daúwd/David (Yirmeyahu/Jer 33:15). Being of four Faces of the DallathDallath, the parables speak of meShich as coming from Yúwsphah/Joseph and Yahúdah may be understood, not as two messiahs, but presentations of the two sides of their faces. The Unique One speaks in the Name of Yahushúo from two sides of the OyinOyin Rings of ALhhim— $\aleph\oplus$  and  $\Phi\Upsilon$ . From the 8 and Their Anointings come all parables to comprehend the origins of Their Words and worlds.

5.  $\Upsilon\zeta\aleph\aleph\aleph$  AchiMalek (Ahimelech) my brother is king, the fifth of Eight (ALphahDibreHhayamim 24:3) extends the blessings/reigns of Laúwi in Yúwsphah to the lands of Amuwri of the left index digit unto the dominion/mamleket Sichúwn/Sihon of the left digitus secundus toe.

6. חַלְקִיָּהוּ Chæliqiyæhh (Hilkiah) a given measurement/share portion of YæHH, the sixth of the Eight (BayitDibreHhayamim 35:8) chief of the House of ALhhim extends the blessings/reigns of Dan in Beniyman in the lands of Kenoni/Canaan of the left middle digit unto the dominion/mamleket Ayshshur of the left digitus middle toe.

7. זְכַרְיָהוּ Zekaryæhu (Zechariah) to recall/recollect/re-member Yahu, the seven of the Eight (BayitDibreHhayamim 35:8) chief of the House of ALhhim extends the recollections from the womb/waters of our Mothers in Ayshshur in shemæyim to the lands of Girgashi, to recall and affirm the pairs of Dallath unto the dominion/mamleket YishmogAL/Ishmael of the left digitus secundus finger/ toe. The REcollections are in the Seventh Stone of the EIGHT as they are in Maneshayh and in the faces of the 14 bones of Neúwn, whereby nothing is ever lost. The Head of Maneshayh, is PedaTSUR, The Ransom of the ROCK, the Head of GamaliAL—ascensions of AL. The Sayings of the Eight Stones, and abundance of Light to make ascensions are in the Rocks of Maneshayh, from which you come forth to your destinies. From these stones all recollections of OyinOyin come forth through the Tongue of Zekkaryahu. These stones were struck twice—repeatedly to divide the flow of waters into two bodies instead of them flowing into one HEAD. What is in the SEED rises to form a full Head of Revelations. The redeeming nature of PEDA of the ROCK/Tsur is within you; however, it must be channeled after the arrow of your destined evolutions. All ascensions come out of Maneshayh, the Rock, to be remembered. The scrolls of the DibreHhaYamim, the Words of the DAYS, and their appointed times open in your generations.

8. יָחִיאל YachiAL (Jehiel) the Life of AL, the eighth of the Eight (BayitDibreHhayamim 35:8) chief of the House of ALhhim extends the blessings/reigns of Nephethli to the lands of Yevusi/Jebus, unto the dominion/mamleket YishARAL of the left little finger/toe/digitus minimus.

**The above Nine/⊕ are the Well of Life/יָם from which all Names are drawn out and return. The 8+1 are the Nine Kuwáhnim, the Counsel of the 8 Dallath and their Anointed.**

THE KINGDOM OF DÆUWD/DAVID —

Within the foundations of the worlds lies the Stone upon which all things are built. When you see the Stone formed by the Graces of the Eight Masters, you build your house upon This Stone of Antiquities and no longer stand in the doctrines of sands that change with the winds and waves. From the underlying Stones of Eight, there are continual ascensions of the Thoughts of Origins, as SeedClusters., bearing fruit of their Names. From these 8 comes the rites of the oylut/continual ascendant offerings.

The Stones of DallathDallath are the patterns of the Tree of Lives to which your Name is called and set in its place for the Joys of meShich (Ref BHM Shuphetim/Judges 19). This is the Rock in the Bemidbar/wilderness— within **the Word**, drawn out from the waters of Metsryim and carried in the bones of Yúwsphah for your Houses of YishARAL. From This Stone of meShich, the waters flow continually to water your

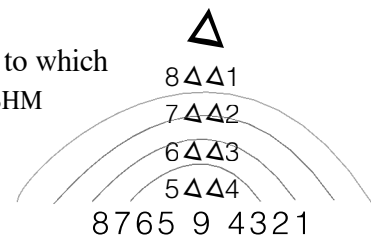

The capstone of Daúwd ΔΔ rises through ascensions

Trees. As you are deemed a precious Stone from the altars of YæHH, you are paired as their Faces and as paired Names and Words of ALhhim who build the City of Avrehhem in which your stone is set.

The Nines are configurations of the pairs of 8's of DAN/ᵐΔ/54 to 63/∧W to 72/ᵑO, to 81/4∟ + 58/OWYאא to 139/⊕∟∟/81+58—a dominion of the fruit of Lammæd. Through progressions of their offerings, they are 54+63 to be 117—a tree of Seven Rings, then with 72 they are 189—bearing the fruit of Chækúwmah; with 81 they are 270—attain to the Life in Understanding of their unified OyinOyin, and with 58 they bear 328 the fulness of ALhhim in Knowledge. The sum of their Numbers are 328 read as three levels of the 28 ALhhim that comprise the Logo of their Eight in which their three Eyes are One. Hereby, the fullness of ALhhim dwells within their children bodily.

The sum of Their Nine are 45 + their the mean Value in their midst of 5 (45÷9), they create the Neúwn/50 through which their Words are drawn out and spoken. The DallathDallath rises from the loins in the midst of your two pillars/legs of LammædLammæd to be seated as the capstone of your Temple of Daúwd. What is sown in your from the Eight rises with the Authority of their Grace whereby they who lay a foundation will complete their House with Shouts of Grace! (Zekeryæhh/Zech 4:7). From the two sides of the 4 pairs of Dallath, the Graces flow of Chækúwmah, the favors of Bayinah, the Graces of ALhhim, and from the top, the Graces of HhaKuwáhnim. These graces are applied as the fat portions as you conduct the oylut offerings. In that They have put all of their grace in you, They know assuredly that you will rise over all of your enemies to reign with them in the Unified Kingdom (Yúwspah/Luke 14:26-33). By their Grace, the Life of your Spirit of maShayh, and your people are accompanied unto your goal through your coming up by the Faces with you (SYM/Ex 33:12-17).

From the Dallath of 54, the legs of the body become two pillars. From the sides of 63 the unified body of Name creates a house for your gemstones. From the sides of 72 and 81 the four arms and wings of your paired sides are unfurled. From the top crowndiamond the Head of Tæyth/⊕ of four faces appears. This is the Body of the 8 and their anointings unto which you are evolving (YechúwzeQAL/Ezekiel 10:21). As you pass beyond your current split body, your backbone becomes the centre of your unified body. Your transitions are made through faith with your evolutionary partner. Dismiss the ideas that your evolutionary transition is far away or needs something other than that which is already present in your DNA strands of AL. As with the Túwrah of Grace, you bring all Words of the paired Dallath within you whereby you enter into the States of Grace—full favor in the Eight (MeshnehTeúwrah/Deuteronomy 30:13-14). You did not forget to pack anything necessary in your suitcase as you caught a flight to earth. Align your parts with the evolutionary destiny of your Name. Keep what you are destined to be in the driver seat. Re-wire your houses to the paired Strands of AL/31 to bear the Faces of YæHH unto the inherent patterns of the DallathDallath— $\Delta\Delta\Delta\Delta \Delta \Delta\Delta\Delta\Delta$  that you stand in full Faith with your origins in the Garden of OODann/Eden. Your Mind of Enlightenment can take you only so far to see from Mount Hhúwr/Hor what is beyond the veils that you are passing through (ChameshHhaPekudim/Numbers 20:11-13). It is of necessity that you heal the waters of strive between split stones/genders and return to your designated sacred partnership pairs as unique formularies/offspring of the Eight. Those who have fear of giving up their ego remain at home—in their bodies of passing as those in the day of Gedoun/ᵐYᵑΔ∧Gideon (Shuphetim/Judges 7:2). The Heads of

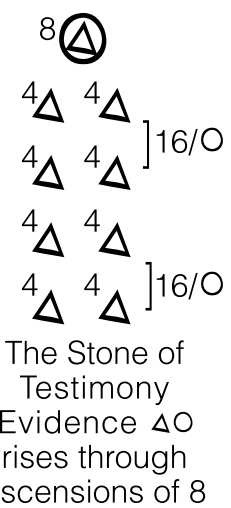



Eight will harden your heart as a stone, whereby you will let your chosen ones pass beyond this phase of dwellings.

The evidence of the Eight within your Name rises to form the Oyin of Consciousness from your stones. As the Consciousness of the Eight in your Name rises, the ΔO—the Stone of Testimony/witness resonates, surrounding your pulsating mind to verify your origins. The paired clusters of Dallath are 16:16—OyinOyin, forming the unified Ring around the capstone. As a halo around the heads of saints; the origin of this Ring is from the OyinOyin Ring of the Eight from which all things are made (Tehillah 33:6; Yahushúo 24:27).

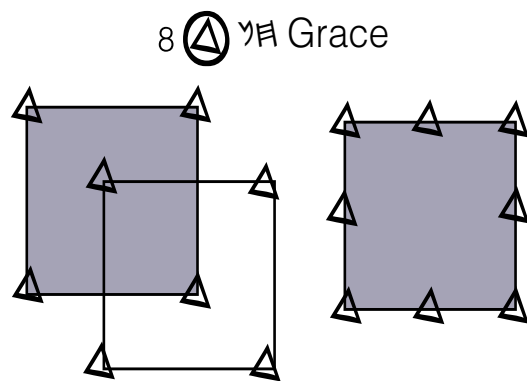

The Origins of the Heart of Bayinah ΔC, the 4 sides of 3, the altar of ascensions through Grace/8, the 32 Teeth of the Mouth, and the 8 corners of the Cube

The grace/58/ O Yin of the House of Yahúwah  
 $58 = 32 + 16 + 8 + 2$   
 rises upon the heads of your offerings,  
 to excude as oil in your Loaves,  
 to lift-up the House 8 of Núwach  
 appearing as Grace and Truth  
 in the Body of Yahushúo/58/ O Yin

### The Cube of Eight

enter in “the City of Gold,” as your heart it is the dwelling of your impartial members cohabiting together as one. In arranging your parts upon the altar, the heart humbles itself to receive your head and to bestow upon your the Graces of the Eight. You mind enters into her as she lowers, whereby your Name is gathered into the Collective fellowship of Names. With outstretched arms of the heart, as wings, you are enfolded with a flutterings of messages to nourish your members. With your offerings you enter through the gate of the House from which you have drawn the offerings to perform your rational service/worship (Tehillah/Ps 100:4; Yahushúo/Josh 2:22, 8:30-34; Yeshoyahu/Is 56:7, 52:1, 61:10; Chazun 3:12; 21:2). Thus, when your oylah offering is of Gad, you enter into the Gate of Gad.

The 8 Dallath:  $8 \times 4 = 32$ , which forms the heart/ΔC, which is the altar upon which their offerings are made as they give the completeness of the unity stone upon stone. The corners are doubled setting 12 places round about. Upon giving all within them, they form the crown of their body. What is in the heart rises unto their Collective Head, as thoughts rise from the heart to be spoken. Through the head of their stones, all things are made as they are spoken. The unified mind of their ascensions is the meshich, the offspring of Daúwd. Hereby, the writings speak that Daúwd is the King forever/olem/ O Yin ΔC, secret concealments. The ascensions of the Eight form the heart and the Reign of Daúwd. Yet who appoints and anoints Malek/King Daúwd to reign?

**The cube of Eight create the square city of Yerushelyim/Jerusalem** (Chazun 21:16-27). What is above descends into that which is made to dwell, thus, the concept of “coming down.” **With the gatering of your stones into the City, the Temple of Daúwd is restored in the midst of chosen generations.** Within the city are 7 Hills that abide in a circle, three on each side with Churab/Horeb at the apex in the midst. The Mountains of Yæhh abide within Nine Ramparts of the 8 Towers and the one in their midst—the Ninth (Chaquq/Habakkuk 2:1).

Upon approaching the Hills of Yæhh with clean hands, the City of Yerushelyim lowers, inviting you to

The cube of city is made by joining the corners of your sides to form the 4 squared city of Yerushelyim. The city of Yerushelyim comes down as a bride to receive you as her bridegroom. The bride takes you into her tent, as on your wedding night, when a woman receives her husband. As the body of your heart is lowered, your Head is placed upon the sum of the parts to enter into your heavenly origins. Within the Collective of the City, your SeedName rises. The Body of Light extends its wings over you whereby you are transferred from earth to shemæyim. In giving all that is within you, you demonstrate that you are as those above, whereby you are accepted by them in unity. The drawing out of all within yourself to perform the oylah creates a vacuum that draws the love of shemæyim unto you, whereby you are fully received into their temple. With the Queens coming down unto you, streams of light from the temple clothe you with radiance. Their glorious retinue fills your sanctuary as their train fills the temple (Yeshoyahu/Is 6:1-4).

According to the house of your offerings you enter into one of the 12 gates of the city and into the secret chambers reserved for your Name. You enter shemæyim by your offerings; there you lay up your treasures in the House of the Queens. On the shevbat you form your residence for seven days as you journey to the north, east, south and west sides of Light until you return home on the full moon to gather your wealth into your House. Each month your spirit goes out for a journey with the sun for 30 days (Mishle/Prov 7:19-20). All that your eyes have seen and your ears have heard and your hands have touched through making your offerings are gathered into your soul chambers. From the full moon you send out another of your servants to make their journey in the paths of the sun (Yirmeyahu 25:4; Metiayæhu 21:33). You do likewise until all of your servants have been sent out, and in the end of your days, you come forth with your bosom abundantly full with the increase of Yahúwah—your Collective to be offered. As you make a journey in the spirals of Bayinah—in the path of the moon, you encompass the four sides of your teraysarunim/Dallath dwellings through which you are schooled in the midrashim of your Name.

The body/ʒ of Names of the Arúwn/Ark—ShmúwAL—are distinguished of ALhhim, in that the Names point out—make evident the functions of ALhhim. Being formed by the Words of ALhhim and shaped by the Breath and Numbers, you are a House of ALhhim. When Chaúwah/Eve, which is the Body sees itself for itself, it takes apart from the Design of DallathDallath, whereby the Design is severed, split as a stone into two parts. She takes one part, and gives the other part to Adam. This is the foundation of the striking the rock twice—setting perceptions to create waters of strife, divisions as separate bodies of gender. The Body itself is whole, feminine by nature, to house its Names of ADIM/adam (plural). The KeRúwvim/Cherubim keep pointing to the way/path to the Tree of Lives.

From 328, the sum of the Eight's offerings, comes Mæyim/𐤎/13 of the 4 pairs of DallathDallath/ΔΔ. Through Mæyim/waters the Word enters into visible parameters to behold, through its three eyes, the thoughts of the Eight. The assembled waters of Mæyim-Tæyth/22, of the House of the double Lammed/Tauweh/𐤎/22, flow as River of Life from the House of Yahúdah of the Numbers of Antiquities (Chazun 22:1-3). Through affirming the Life of Eight in yourself, you make your ascensions through your manifestations. The ability to transform yourself from the Fire of the 8 into waters—to engage in alchemy—the chemistry of AL—is through the three levels of ALhhim in meShich. What is in waters of Ruæch—the Intelligence of the Eight—as Spirit, distills into wine. Into these clear streams of waters you see yourself as in a mirror. The waters of your body are not different than your Ruæch.

Rather the waters, blood and flesh of your dwellings are Tents of your Betrothal/Union of Pairs which are in agreement with your Ruæch. Your body is a house to assemble your facets of stones. For how could your Ruæch create something that it does not know? While we refer to the body often as an illusion, it is because we are yet distant from the patterns contained within. The blood that quickens and pulses you to have understanding/redemption is yet to be offered for your illumination. That is, without sacrifice of the Eight, you are a stranger to yourself. Through your givings, the waters rise and fall as the tides of the moon for subsequent unions with the Eight.

What is formulated as the body is presented to the Crown. *e.g.* Shamoúnn of the ÚWah-Bayit ALhhim (a unity of houses) is given to Tsædda Tsædda—the Crowns of YæHH. What you give yourself unto totally appears within you. Thus, as you give yourself to the Crowns, they appear in you, or as you give yourself to the Body of ALhhim, the ALhhim appear in you (Tehillah 101:2). What you release of the Eight shows-up—presents! There is nothing unclean in you, not your semen, nor blood, nor tissues. The issues of your Life are for your growth and development, provided for the joy of giving and fruitfulness. You cannot make yourself dirty by a wet emissions or having a period discharge. All releases culminate in becoming clean—further levels of enlightenment. “You will become clean/whitened”—Read Túwrahh! (TK/Lev 15:19). Pure language is speaking thoughts of the Eight—the **thoughts of everlasting support**—encouragement, steadfastness, **and reciprocities**—freely giving, mutuality. The sum of their Teachings is LOVE: 2+2=4. You walk by and speak the Words of Túwrahh unto another’s Faces—your neighbor who you respect as yourself.

Studies of 328 to 13 and to 4 are the basis for the works of AL-chemy—processes that change or transform one state unto another. When the Mind of meShich commences to flow, as it is the nature of all things of the Eight to give freely of themselves, there are Waters above/ascending and below/descending. From ascending and descending waters there appears your bodies below and your heads above. What forms in the crown of the Eight must die—to be released as the seeds of the sunflower; nothing abides unto itself or remains alone. All things are for the CollectiveGood according to the Consortium of the Eight. Within your waters the Words of the ALhhim activate—move upon—causing to appear your Nature of the Eight in Tæyth/Tæyth/Tet/9. Hence, the creation.

Within your hands, the stones bear witness of your deeds to record everything within the circles of your Name. You write your own book by what you do. In your stones are your testimonies of origins, alignments and righteousness. What is in the midst, extending from your heart, is the arm of salvation, stretched out, able to save your branches to the uttermost. Out of these stones runs the strands/filaments of AL to the fingers which appoint/stimulate and carry the pulsations of subatomic particles of Light to transform Their Thoughts into your deeds. Also the strands of AL, as nerves, run to the corresponding toes to fulfill your journey/assignment. In that your feet are shod with the GoodNews of this Everlasting Kingdom that is made of stones/jewels/clusters which do not perish, your shoes of these stones do not wear out. The drawing out of this Rock supplies the unified thoughts in the waters to run unto your Collective Pairs of ΔΔ/44, HhaTsur. The ascent the DallathDallath rises unto the capstone of your assembly built to the Name of Yahúwah. Anything not pertaining to these Stones of solidarity is considered as dung; there is nothing more to cherish than the Stone of your Name.

## THE 21 ALOZAR KUWÁHNIM OF THE LETTERS OF ALHHIM

Through making the menurahh daily, you see the Faces of the 21 Kuwáhnim who appear according to the Rings of your offerings. e.g. On the day of making the offerings of Dan, the Kuwáhnim of Shayin and Semek attend to your illumination as the Word flames into your Seven Fold Spirit. The Names of the Eight of the 21 Letters of ALhhim are inscribed in ALphahDibreHhaYamim. (1 Chronicles 6:1-15, Aramaic version 5:30-40). These Kuwáhnim appear to you as you make and trim the menurahh evening and morning as the branches and wicks are set per your offerings. The Kuwáhnim are of the ALOZAR lineage which attend to you during making your offerings. According to which offerings of ALhhim you are making, the corresponding Kuwáhnim are present. e.g.. For offerings of Nephethi DallathDallath, 𐤒𐤐𐤕 OyZi is attending.

## HHAKUWÆHNAYI HHAALHHIM/THE ILLUMINATORS/SERVANTS OF THE ALHHIM

DibreHhaYamim/I Chronicles 6:1-15 (Aramaic Ver 5:30-40)

The Serving Illuminators of Wisdom of the Hearts of 8: 7+1, 6+2; 5+3; 4+4 = 32/𐤔

The ALphah are of Kuwáhnim of 𐤍𐤏𐤓𐤕 Pinchæs, 8:8, kuwáhnim/serving illuminators of ALphah, to bronze, correct, pierce/open completely, the flame as a sword, tongue inside opens the seed

The Bayit are of Kuwáhnim 𐤁𐤕𐤕𐤓 Avishauo, 4:4:4, kuwáhnim of Bayit, "my father reclaims," restores, saves through administrations of the two sides of Light, whereby nothing of Unity is lost or forsaken

The Gammal are of Kuwáhnim 𐤂𐤏𐤓 Bæqi, 2:2, kuwáhnim of GammAL, to cause a vine to spread, to pour out, a conduit of reservoirs

The Dallath are of Kuwáhnim 𐤒𐤐𐤕 OyZi, 8:8, kuwáhnim of Dallath, emitting strengths of your Stone, beloved Name of Dæuwd, saying of sevenseven, the Faces of Words 𐤇𐤕, 87:87, sayings of perfections of Bayinah and Chækúwmah

The Hhúwa are of Kuwáhnim 𐤏𐤕𐤕𐤓 ZeRechYæh, 7:7, kuwáhnim of Hhúwa, radiance, shining glory, brilliance of the illumination

The ÚWah are of Kuwáhnim 𐤕𐤕𐤕 Meriúwt, 7:7, kuwáhnim of ÚWah, illuminates selective choices, reveals what belongs together, as night and day, pairs

The Zayin are of Kuwáhnim 𐤏𐤕𐤕 AmariYah, 7:7, kuwáhnim of Zayin, bearing Sayings of the Illuminations

The Serving Illuminators of The Sayings of Understanding Ascensions,

Internal Pairs 2+2 as 88: 22/4 14+8, 13+9; 12+10; 11+11 = 88/𐤔

The Chayit are of Kuwáhnim 𐤕𐤕𐤕 Achiytuv, 9:9, kuwáhnim of Chayit, elevations through collective goodness, upholds ALhhim

The Tæyth are of Kuwáhnim 𐤕𐤕𐤕 Tsaduwq/Zadok, 9:9, kuwáhnim of Tæyth, consecrations of tones, upward momentum to the crown

The Yeúwd are of Kuwáhnim 𐤕𐤕𐤕 Achiyots. 2:2, kuwáhnim of Yeúwd, comrades of mutual teachings imparted, activating trees on the slopes of the Mountain, trees of goodness and associations, appointments of deeds of the Stone

The Kephúw are of Kuwáhnim 𐤕𐤕𐤕 OZerYæh, 7:7, kuwáhnim of Kephúw, strengths of Yæhh imparted to branches, three veins of the blood for the lands and gates in your Name, affecting access and states of residences as your Name is cultivated, YæHH bears both sides of a tree

The Lammæd are of Kuwáhnim 𐤕𐤕𐤕 YuachNuN, 7:7, kuwáhnim of Lammed, teachings of the Laws of Grace, to bend as branches in the wind, creating dances of swaying, swirling, leaping, to feast from the mouths

The Mæyim are of Kuwáhnim  $\aleph 4 \text{IO OZerYæh}$ , 7:7, kuwáhnim of Mæyim, strengths of Yæhh flowing through waters below and above' to bring to a head what lies in the waters

The Neúwn are of Kuwáhnim  $\aleph 4 \text{M} \aleph \text{AmariYah}$ , 7:7, kuwáhnim of Neúwn, Sayings of Yæhh through the 28 mouths of HhaALhhim

The Serving Kuwahnim of Knowledge 36: 32 ascending through the Gate/4 of the Keveshim  
 $21+15, 20+16, 19+17; 18+18; = 144/\Delta \text{M}$

The Semek are of Kuwáhnim  $\text{M} \text{Y} \oplus \text{L} \text{M} \aleph \text{Achiytuv}$ , 9:9, kuwáhnim of Semek, comrades are of the collective orders of goodness/pairs

The Oyin are of Kuwáhnim  $\text{M} \text{Y} \Delta \text{L} \text{TsaduWq}$ , 9:9, kuwáhnim of Oyin, consecration of rings, commitments to visions, crown of consciousness

The Paúwah are of Kuwáhnim  $\text{M} \text{Y} \text{C} \text{W} \text{Shalum}$ , 4:4, kuwáhnim of Paúwah, utterances of peace, quad faces united, to make full, complete

The Tsædda are of Kuwáhnim  $\aleph \text{L} \text{M} \text{L} \text{ChæluWqYæhh}$ , ChæliqiYæhh, 8:8 kuwáhnim of Tsædda, transformations, forming dominions, distributions, lots, appropriations of YæHH, double portions of silver and gold, lots from both sides of the tongue, mind, mountain, double blessing

The Qaúph are of Kuwáhnim  $\aleph \text{L} 4 \text{OI OZerYæh}$ , 7:7, kuwáhnim of Qaúph, strengths of Yæhh consecrations of Numbers, verifications, setting you apart to the ALhhim and the Faces of Enlightenment

The Rayish are of Kuwáhnim  $\aleph \text{L} 4 \text{W} \text{SharYæh}$ , 6:6, kuwáhnim of Rayish, prince of YæHH, elevating your Name to rule, have dominion, to unfurl your inner strengths

The Shayin are of Kuwáhnim  $\text{M} \Delta \text{L} \text{Y} \aleph \text{Yæhutsedaq}$ , 6:6, a Name of 15:15;  $\aleph / 15/6 = \text{M} \Delta \text{L} / 15/6$ , kuwáhnim of Shayin, Enlightenment to align Rings/Eyes unto righteous columns

The Serving Illuminators of The Arúwn/The Ark, States of Enlightenment  
 ALphahDibreHhayamim/I Chron 16:4-6

The 7 Serving Illuminators of The Seven Eyes of ALhhim  
 ALphahDibreHhayamim/I Chron 16:37-42

The Kuwáhnim of ZayinALphah-ÚWahBayit  $\text{M} \aleph \aleph \text{Asaph}$

The Kuwáhnim of HhúwaGammal-DallathDallath  $\text{M} \Delta \aleph \Delta \text{O} \text{OvadAdim}$  of 68, a formulary of

of the Rock of DallathDallath:  $\Delta \text{Y} \Delta = 14 \times 4 = 56 +$  their begotten of  $\Delta$  to be 60, plus the 8 of Hhúwa-Gammal

The Kuwáhnim of NeúwnChayit-MæyimTæyth  $\text{M} \text{Y} \times \text{L} \Delta \text{L} \text{M} \text{Y} \text{BenYedyithun}$  (12:12)

The Kuwáhnim of LammedYeúwd-KephúwKephúw  $\aleph \aleph \text{Chusahh}$

The Kuwáhnim of ShayinSemek-RayishOyin  $\text{M} \text{Y} \Delta \text{L} \text{TsaduWq}$

The Kuwáhnim of QuaphPaúwah-TsæddaTsædda  $\text{M} \text{M} \aleph \text{Himman}$

The Kuwáhnim of ARiAL  $\text{M} \text{Y} \times \text{Y} \Delta \text{L} \text{Yedduthun}$  (15:15)

The Priests of Knowledge 36: 32 ascending through the Gate/4 of the Keveshim  
 $21/15, 20+16, 19+17; 18+18; = 144/\Delta \text{M}$

The Semek are of Kuwáhnim  $\text{M} \text{Y} \oplus \text{L} \text{M} \aleph \text{Achiytuv}$ , 9:9

The Oyin are of Kuwáhnim  $\text{M} \text{Y} \Delta \text{L} \text{TsaduWq}$ , 9:9

The Paúwah are of Kuwáhnim  $\text{M} \text{Y} \text{C} \text{W} \text{Shalum}$ , 4:4

# 12 PAIRS OF KUWAHNIM AND THEIR MOONS

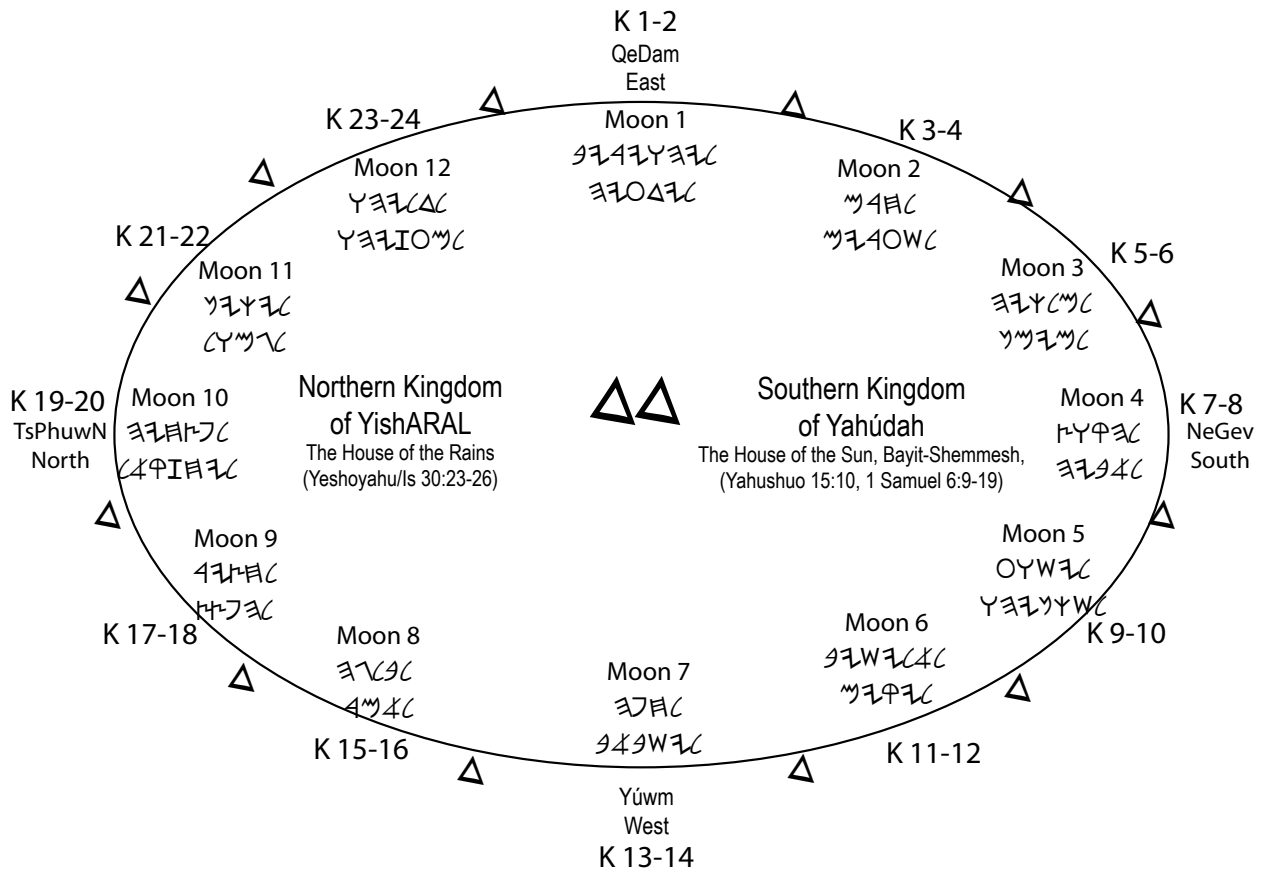

The 12 Pairs of Lammed-Lammed Names for the Nights and the Days  
To Provide Instructions of Support and Reciprocal Actions

moon	Lammed of Night	Lammed of Day	12 Gates open on Rash Chadash
1	ጎጊጎጊጎጎጎጎ Yahuyeriv/K1	ጎጎጎጎጎጎ YadooYæh/K2	K 1+2      3 of Δ
2	ጎጎጎጎ Ch'rrem/K3	ጎጎጎጎጎጎ Shooryim/K4	K 3+4      7 of Δ
3	ጎጎጎጎጎጎ Malakyæhh/K5	ጎጎጎጎጎጎ Mayemen/K6	K 5+6      11 of Δ
4	ጎጎጎጎ Hequts/K7	ጎጎጎጎጎጎ AviYæh/K8	K 7+8      15 of Δ
5	ጎጎጎጎጎጎ Yeshúwo/K9	ጎጎጎጎጎጎ ShakanYæhu/K10	K 9+10     19 of Δ
6	ጎጎጎጎጎጎጎ Alyeshyiv/K11	ጎጎጎጎጎጎ Yaqim/K12	K 11+12    23 of Δ
7	ጎጎጎጎ Chuphah/K13	ጎጎጎጎጎጎ YashevAV/K14	K 13+14    27 of Δ
8	ጎጎጎጎ Belgahh/K15	ጎጎጎጎ Amúwr/K16	K 15+16    31 of Δ
9	ጎጎጎጎ Cheziur/K17	ጎጎጎጎጎጎ Haphutsats/K18	K 17+18    35 of Δ
10	ጎጎጎጎጎጎጎ PættechYæh/K19	ጎጎጎጎጎጎጎ YechúwzeqAL/K20	K 19+20    39 of Δ
11	ጎጎጎጎጎጎ Yakin/K21	ጎጎጎጎጎጎ Gamul/K22	K 21+22    43 of Δ
12	ጎጎጎጎጎጎጎ Dulyahu/K223	ጎጎጎጎጎጎጎ Moúwzyæhu/K24	K 23+24    47 of Δ

## 12 COURSES OF KUWAHNIM AND THEIR MOONS

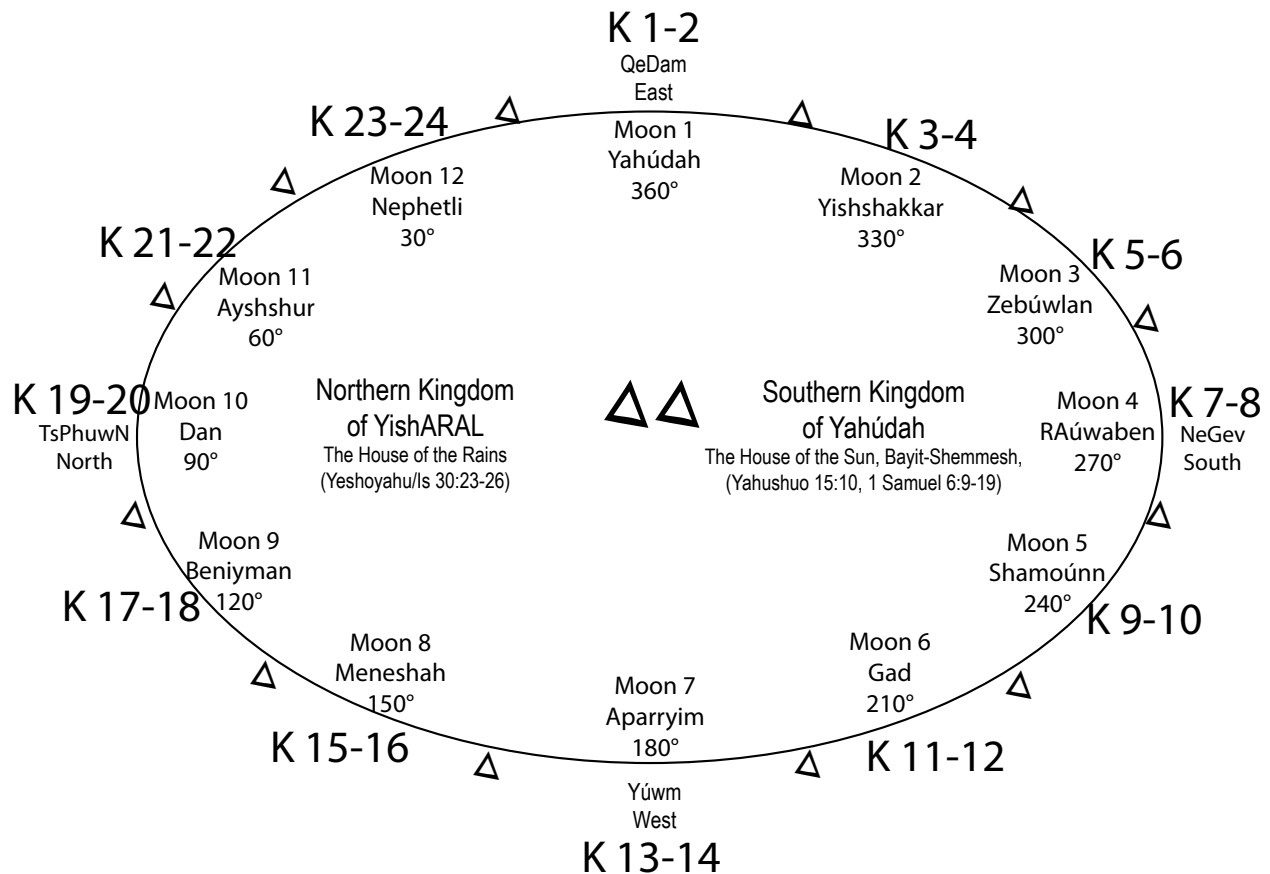

The 12 sets of kuwahnim stand poised through the year in their assigned courses of nights and days. Two priests, as pairs, assist the processes of the offerings in a moon phase for their thirty days. The Names of the paired kuwahnim are activations of Enlightenment that cause spirals of ascensions and the blood to flow within our garments from morning/observations to their fulfillments with understanding/evening. The tipping of the Rod of Aharúwan into the waters of the kaiyuwer is like an bolt of lighting that causes the lame to walk and the blind to see, whereby we step forward though making our offerings unto our destinies.

There are two K (kuwahnim) for each of the 12 Houses and their day. These kuwahnim serve the offerings of the Nights and the Days in a moon cycle. Their Names are registered in the Dibrehhayamim/Words of the Days, 1 Chronicles 24:1-18. In accordance with the Túwrah being of 2 sides, Words of Support unto Reciprocal Actions, so are the Nights and Days set for instructions unto their observable expressions. The Nights and Days of a moon are of the House of Lauwi—the Lammed of the Bones which provide support and the Yeúwd of the Hands to fulfill reciprocal actions.

These 24 Names are of the House of ALozAR and Ayithamar. 16 Names are of ALozAR and 8 are of the lineage of Ayithamar, Within the Reciprocal Rings of Oyin are the ascensions of the Eight/Chayit. Their Numbers form the word 𐤀𐤋𐤁, meaning to partition.

The Tsædda are of Kuwáhnim צדק צדק ChæluwqYæhh, (ChæliqiYæhh) 8:8

The Qaúph are of Kuwáhnim צדק 40I OZerYæh, 7:7, strengths and verifications through Numbers

The Rayish are of Kuwáhnim צדק 4W SharYæh, 6:6

The Shayin are of Kuwáhnim פדףףףף Yæhutsadæq, Enlightenment for alignments of Rings unto a righteous column

THE 24 KUWÁHNIM OF THE LAMMÆD TO GOVERN NIGHT AND DAY

The Kuwáhnim of 24 are composed of sets of 16 and 8 (ALphahDibreHhaYamim/1 Chronicles 24:1-18). They are one and the same as the pairs of Eights in OYIN/16, which form the two sides of a ring: 180+180. The Eights give of themselves whereby they are distinguished as Dallath pairs. They distinguish themselves as pairs of 8's to be 71, 62, 53 and 44 unto forming a crown of Nine, and then by 54, 63, 72, 81 unto 139 to build a house/body and form their Head of meShich. By adding one—being unified totally of Their 8's, They bear their unique offspring of meShich/9. The 24 Kuwáhnim appear to you night and day as you come to the Table of Faces, standing to the left and right as the Guardians of the Bread. Throughout the Night and Day they are performing their Courses of service from the evening to the dawn there are a mixing of Lights as the mixing of the Kuwáhnim of ALOzAR and Ayithamar. These Names are from two staffs of Aharúwan—the pole of ALOzAR and the coverings of Ayithamar—the two sides of ALphah/4 from which comes the stalk and the leaves. They administer the Lights of night and day and their colours.

The Kuwáhnim/priests of the Lammæd/Rule of Night, 12, on the Side of Bayinah, which governs

the Houses of Aparityim. The Kuwáhnim/priest of the Lammæd/Rule of Day, 12, on the Side of Chækúwmah which governs the Houses of Yahúdah. These 24 kuwahnim of the double Lammed/LL form the House of the Taúweh/X which connects all Words of ALhhim into teachings of the 48 Centres of HhaLaúwi. In the midst of the month, on the 15th of AaVShmúwAL, the paired Kuwáhnim join into one body/house to generate re-newing thoughts/generations of progressions. From this house the oils of the anointing flow upon every Name born of the double Dallath and the Nine of HhaKuwáhnim.

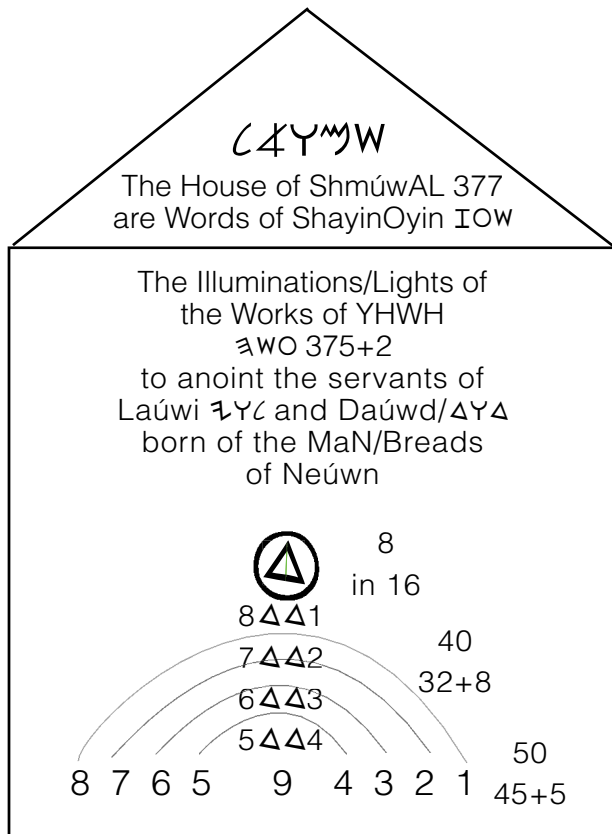

Within your House of ShmúwAL—your Name of AL, the kings of YishARAL are anointed who pen with their hands the Works of the OyinShayinHhúwa (ALphahShmúwAL 3:1-3). Through the anointings of ShmúwAL, the House of Daúwd rises and the dominion of the Kingdom of YishARAL (ALphahShmúwAL 13:19; BayitShmúwAL 5:1-5).



The formularies in the Name of ShmúwAL, of 377, are the Seed of the House/Body of the Lights of Oyin and Shayin. The facets of the Dallath combine to House the Names of Fire and their embodiments into one Seed/4 of ShmúwAL. The 50 are of Neúwn, 45+ the 5 mean value in Nine. The Pairs of Stones 54, 63, 72, and 81 form the Mind of Understanding: 270.

Within these are 40 of the Altar/32—its activations of waters and anointings of oil in 8. The forty are the activations and anointings in the House of Laúwi, the Lammæd/30 + the corresponding deed of Yeuwd/10. To these add the 16 facets of the sides of the foundations of the Temple of 8 Stones—the City of Yerushelyim, as a cube. Together, the sum is 376 comprise the House/Body/9 of the Works of Light ɚWO that congregate in the Principle ALphah/1 of paired Names of ShmúwAL (376+1) who anoints Names unto their purposes and places.

In the Seed of ShmúwAL are the Bread and the Oil to designate and feed Houses of Daúwd/David and Laúwi (48) covenants/studies with administrations of the Graces of Eight (Yirmeyahu 33:20-22). The 48 covenants are the 48 Cities of HhaLaúwi as well as the 4 Faces of the 12 moons, of which are the 4 Faces of the double Lammæd of night and day.

The House of ShmúwAL, are pairs of faces (53/17, Paúwah of the 8)  
 of ɚOW 375 (to comprehend the ascensions of YæHH, 78/15 of the three lights: 5 3’s/53)  
 the 15 Fathers of ƆƆÆɚ HhaSeloo/the Stone (165/12 in which are 12 Heads of Yæhh)  
 of the 8 Ascensions of Life moving in the 8 Rings of Yæhh (paired Faces of the Eight)  
 15+1; 14+2; 13+3; 12+4; 11+5; 10+6; 9+7; 8+8  
 (128 of which are the branches Ɂ of the Unified ALhhim)  
 which abide in Names to appear and rise through the strands of AL/31 (15x31=332/8)  
 to unify their Faces ɚʁɚʁ56ɚʁɚʁ56 of Neúwn/ɁɁɁ (5665/22) to be one/achadd.

ShmúwAL 340 + 6 +31=377 IOW

The Numbers 340 of a Name/ɚW are the three levels of instructions/40 in the life of spirit (SYM 1-7).  
 In the midst of Ɔ4/31 are the 6/Bonds of the Lights of 375/15/6/Ɂ of a Name/ɚW.

From the altars of Yæhh you are created as a Seed of the Adim. Your SeedName is cast upon the waters whereby it rises and returns with its hands full. This is the DEREK, the Paths of ALhhim. Through your formulations of Mæyim and their gatherings in Tæyth, you make your ascensions to affirm the Lights of ALhhim in you. Through the processes of evolutions you know the details of all that you are given whereby you have the exuberant joy of residing in them. As one taught of ALhhim and their kuwahnim, you come to the chair of your Name to reign as king DaúwD. As living with your sheep, as a caretaker of lambs, namely dressing daily your offerings, you are anointed by the oil of the Eight by the Hand of ShmúwAL—the flowing Fire of Oil through 15 strands that burst open. From the Fires of the altar, to their condensations for meditations, you put on skins, as a cocoon to know your transformation, to habitat as a concealed Star of Light, unto the day that you appear in the Eastern Gate, and take in your hands of humility the gifts of the Wise. Through your ascensions, rising through your body-lands you are revealed from the dung heaps left behind to be the Offspring of ALhhim!

The Tabernacle of Daúwd is said to have fallen as the inner structure of the unified DallathDallath is torn down/forsaken/comes up missing in the hearts of their peoples. Aligning your stones to the Cornerstone of YæHH raises up the House of DæuwD, whereby thieves are not able to enter and carry off the treasures of your temple. DæuwD is said to be after my Heart, in that this is the foundational Name of the Stone of DallathDallath that is laid in your dwellings. Deployment of your davidic parts pertain to the structure of the Words of the Eight being ripped out like treads of truth from your inhabitants. Carried away from your temple Light dwellings are ideas of the oylah/ascensions and bearing the Illuminations of the Seven Masters within your branches. Through your services within the Eight you re-acquire the treasuries of gold, silver and bronze that were stolen. The many threads woven to replace the

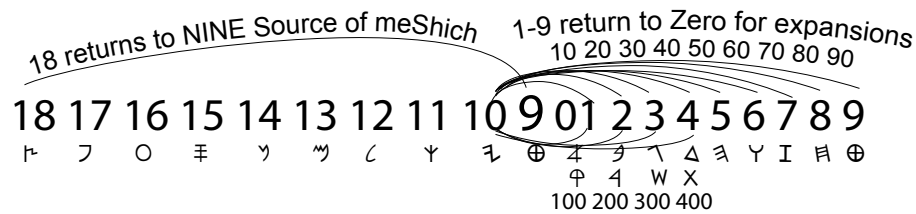

### Source of Numerals in Dallath/Δ/4 OO

$$1234=10$$

### The Return to the OO of Laúwi/40 (30+10)

associations of the Names of YæHH are foreign garments of ideals, doctrines and philosophies. Though tantalizing to the ears, they soon wear-out. The teachings of the Eight lead you to the Dallath Gate of Yerushelyim in which you are robed with their glorious fabriques. As Sheep, you hear Their Voice, to enter into HhaDerek Kevashim—the Paths of Lambs up the sides of the Hills. During their festivals of 8—the Eight of Pessech; the Eight of Shebuoúwt, and the Eight of Sukkut you appear in your three elevations unto their Faces though which you carry their Illuminations within you, Faces to Faces. Through Aharúwan, the blessings of the Faces of Yehu rest upon you, unto your totality, as the Words are spoken through the Dallath in HhaSham to the Gates in your Name (CHP/Num 6:23-27).

#### THE SOURCE OF NUMERALS IN THE EIGHT

The rod of Yahúdah-Aparryim release the Numbers in the Stone form 00 - 400. The embedded consciousness of the Dallath/Δ is Taúweh/𐤀 through which the instructions of their Nine Schools house the inhabitants of their kingdoms.

The Rod of 68100 is of Yahúdah/610, and the Sayings of Light in Aparryim/80, read as the Unified/6 zeros/00 of Life/18. The 18/𐤒𐤠 is the Light of Life in the midst of Yæhh through which all in them appear in the 𐤒𐤒𐤐/olamim/worlds/concealments of Illuminations. Through your 18/Life, you become masters, ascending over the waters. From the midst of these numerals, the Letters appear to express their unified combinations of joyful utterances. The Illumination of the kuwahnim/priests of Aharúwan, dress the Numbers with the Enlightenment of their Teachings drawn from the numerals.

By Their Numerals, The Eight and Their Anointed attest/verify their Words in the rod of Yahudah/610 that opens in the mouth of Aparryim/80: 68100: 600/𐤑 OO, Yæhh Consciousness is set in Testimonies ΔO𐤑O.

10 81 10  
 10 9 10  
 6 7

THE NUMBERS OF THE EIGHT AND THEIR ANOINTED AS 18 9

Within the 4 are 123, and within them are 3 tens that comprise Lammed. The three levels of extension are the Staff of your Name and the Teachings that are in-laid as stripes in your bones. According to the three levels of Tens in your Seed, so you have your house/body to extend your Name from the double yolk Egg OO of Maneshayh unto a flying cockatrice of Zebúwan that rises from the nest of your body.

The three levels of 10 are the means for your Name to fulfill the Words of ALhhim, which comprise the teachings of Laúwi/לֹוֹי: Lammed/12 + ÚWah/6 + Yeúwd/10 = 28/1, whereby comes the saying that the ALhhim are achadd/one. The three tens of the Eight are the Yeúwd (2 4's 1+3 and 4), the ascending Bayit activated (2+8), and the Life of the Stones given—28 18+10—paired Eights of ALhhim. The numerical cardinals and the ordinals of progressions, added together, make-up the writings of the Lammed. These writings are inscribed by the mouths of the keRuwwim into the coats/fabrics of your souls as you gather the spices from your oylut. The reductive sum of the paired keRúwwim (כָּרֻּוּוִּים) are 15:15 who flutter their messages of Lammed/30.

The OO-400 of the Eight could give no more nor less as they have given freely all for their utmost Joy. The Numbers and the associations of Rings create the olem in which are the Paths of the Ancients. The way to enter into these paths of antiquities are HhaDerek Kevashim—the Way of the Lambs. As you give all within your Name through the intervals of your days, you enter into the Eight and their anointed, for you are of the same SpiritMindBody.

6 7

The Kuwáhnim give all that is within them of the Rock—30 + 10 = 4 O to share their secrets. Through their teachings they give all within the Rock whereby every Name has a body of waters to behold their gifts and treasuries of Grace. Through the waters of the kaiyúwer, designated for the Laúwi activations, the Laúwi gather all in their midst that flows from the Life of meShich/⊕, to impart Life/לַיִם. Through the hands they create Aparryim/אֲפָרַיִם from whom comes all blessings/expansions of the NiNe. Hence, from the waters/40, you appear to bear your Light.

אֲפָרַיִם  
 40 12 9

According to the Numbers of the Eight and their Anointed, Aparryim bears the 12 in 40. From the calculations/givings of Laúwi, in which are Yahúdah, you are manifested through Aparryim with utter joy. Your 12 are gathered into Metsryim unto Yúwsphah. Through the loins of Aparryim comes 1039 of Beniyman which gives the full measures of 10 of their Staff of 30 of the Life/18/9. For this reason the kuwahnim speak and teach to live a distinguished/set-apart Life to sanctify all peoples of the stars/planets, including all species unto their Source of Life Eternal.

The Lights in the Nine draw out of themselves to create/express all things. The Life/לע/18 flows from the lips of HhaKuwáhnim. Through utterances of their Sanctified Sayings/74/180, you and all within are quDash/distinguished unto the Rock of your Redeemer. When the 1 of 8 rises in all creations, then your Life swallows up death; whereby you are ushered into the Joys of your labours. You enter into the Gates of Lives, into the Joys of Reshun, who imparts all things freely to you. The ascent of the meShich is the 1 of the 8 of Núwach, that comes from all nations, unto a total redemption of souls—*tikkun olam*—spoken by the mouths of the Kuwáhnim. The salvation of the olem through the Name of Yahushúo, and there is no other Name in you whereby you are saved.

The Shauo/salvation is laid-up in Shamoúnn from which comes the Pessech offerings of liberté, enabling you to break out from former states. Through Shamoúnn you make a full ascent upon your staff. In making your Shamoúnn offerings of the ÚWah-Bayit—from your unified house—you are able to fully ascend the slopes of Yæhh. Through Shamoúnn in every offering, your entire house is lifted as one body. The kuwahan/priest/illumination of Shamoúnn is Avihshauo, the Father of Salvation ((1 Chronicles 6:4-5, Aramaic version 5:31). The parts of your offerings are devoted to your Name in the Colective whereby your 12 act as one to fulfill your ascension; there are no laggards, all of your members go together hand-in-hand up the Hill. The offerings of Shamounn are made unto its Head, whereby what is in the body of Shamounn is fully given for the Crown/ר to form upon your Head. As the crown forms through your full ascensions, you are noted as the King of the Yahúdah—a master to rule by the Numbers of your Name. The crown of thorns appears through successive stages of growth, in similitude of the ear of wheat with its awns.

As with the forming of the Crown upon a stalk of wheat, you develop your Dallath Crown in succession until the full ear of 8 pairs or 16 thorns/awns rise from your brow encircling your head. The benchmark for number of grains per ear of wheat is 36, as the Number of Dallath (8x4) in the Eight plus their Anointed (4) which rise from your SeedName. The number of grains in your head is an important yield component of your Origins of the Eight. The number of grains generated in a season is affected by the growing conditions as your Name flowers. The wheat ear development appears in 19/Tsædda days from flag leaf to ear emergence. In that your Spirit, as a stalk of the field, naturally turn towards the Light as you emerge, you rise straight-up, whereby your stalks are not bent-over nor crooked. The Lights encircle you evening and morning drawing you out from both sides to keep your posture in an up-right stance. In positioning yourself to receive and extend the Lights, obstacles that could overshadow your Name vanish in the Lights as you stand within the Faces of GRACES and Their illuminations.

Your Body is formed to house the Lights of Bayinah and Chækúwmah. In the unity of pairs there is salvation, whereby Names are fully restored to their positions in the Tsur/Rock. While the eyes may search elsewhere for a redeemer, the Stone of Shamoúnn, upon which the House is built, is within you. Upon this Rock, the Consciousness of Shauo builds an cohesive assembly.

The Name Tsur is in the Head of Shamoúnn, Tsurishadai—my double Dallath Rock is abundant, every supplying from the Breast of the Queens to provide your states of residences and nurture you in their quarters. From Shamoúnn, the Crown of Tsædda, with the double Dallath is formed to be placed upon your ascending Head of 18. Though there are many lessons to be learned, the ultimate lesson to be performed is becoming united to your pair to form the sevenseven, whereby you are given access to the oodann/garden, as only pairs are accepted into the Tevah/ark of Núwach/Noah

for the culmination of being sown in the earth. Through conducting yourself to another as yourself, you fulfill the Words of Túwrah without shortcomings. Amongst the 7 things that the Collective Spirit of a Name hates is disrupting the unified states of comrades/pairs (Mishle 6).

When DAN—the Judge of your Name comes, the goats are distinguished by their strengths of understanding; however, the lambs of Shamoúnn, who are meek and follow-through on the teachings are given access to the gates of lives. Pride of knowing the most concealed secrets will not suffice as the means of full ascensions from one state to another. Knowledge provides clarity of mind and the joys of the heart whereby you attain strength to give all that you have in humble service to the Collective. With knowledge in the heart one can point the way; however, the derek/path of lambs is opened by the hands that extend from the sides of the heart to attain the goal.

The stone of DallathDallath is hidden in the walls of Shamoúnn. As your StoneName rises it appears as the cap stone in the Faces of Ayshshur, making evident the double Dallath in Tsædda. As the rings of ZayinALphæh and ÚWah-Bayit house the stone of your Name, your stone rises from the waters of Ayshshur through which you are born from one domain unto another. In the House of Dan, which is the Body of Ayshshur, you are called from your Mothers of ALhhim to appear with your crown of jewels. For this reason you are sent into the earth/ᵀ44, to bear the Light of the Crown of your Name. The illuminations of AR/44 are set upon you evening and morning to cause your Crown/ᵀ to appear.

THE NUMBER OF THE TÚWRAHH —  
THE ASSEMBLE OF KUWÁHNIM/PRIESTS AND THEIR MESSAGES

The Túwrahh scrolls are writings of Chayit/8, as a Work of the Lights of Reshun—the Mind of Neúwn. The deeds/ᵀ of Light are composed of the Words of the Fathers/Zayin+ALphæh—from concept/1 to fulfillment/7. From the Number base of Thought, the pulsations of NaDæv, the 8th Father, flow from the joy of Yetschaq/1 unto the complete enlightenment of Aharúwan/7, who pens the thoughts as streams of Light enter into the mind. From the 7 Fathers on the left of NaDæv unto the 7 on the right of NaDæv, the Mind of Neúwn/14 flows with every detail of perfection.

Eight is the Number of the Túwrahh/ᵀ4YX/53/8 and the Number of the kuwahren hhameshich/the anointed priest—mShich/messiah—which serves in the Name of the Divine Order/ᵀ4YᵀW/53/8. **According to the Values of 8/ᵀ every word of the Túwrahh is penned by Fire to be performed.** Chiefly, the Túwrahh contains the messages of love/ᵀᵀ4/8. The Number 8 is on one plane a combination of ALphæh plus the seven spaces of Zayin. By the tongue of Zayin I, the ALphæh 4 idea is completely extended. The fulfillment of every SeedName is secured because it is a construct of perfection whereby the ideas within the Seed cannot fail. As every Seed yields a harvest, so does every Name bear its fruit according to its Light. Each Name is a unique fingerprint to fulfill their words of truth.

The seven spaces between the Letters ALphæh and Chayit are also set between the three rows of Letters whereby the Neúwn Mind is within the ALhhim and their Words [See BHM ALphæh Bayit book for further details and illustrations]. i.e. Between each Letter of Neúwn there are two sevens or 14 ᵀ. Between Zayin/7 and Shayin/21 is 14; between Bayit/2 and Oyin/16 is the Neúwn. According to the pairs of 7 in the midst of ALhhim, the Words of the Teúwrah are of One Mind and thereby is One Law. The complete extension of ALphæh is drawn out via 7 Days—through complete acts. Eight is the basis of

Unity/ALphæh/1 plus its complete extension/7,  $1 + 7 = 8$ . Eight is the sign of the Principal's descension/ascension/perpetual motion and also the Collective Name of YæHúwaH/26/8. **When 8 is active in a SeedName, all words of a Name are released unto expressing the Totality of Light.**

*The Túwrahh are the scrolls of infinity/8. The parables of the Law are Unified Words of Wisdom formed in the mouths of YæHúwaH. Within Wisdom are the Sayings of Understanding which hold all thoughts together and Knowledge which bears the fruit of the Thoughts. By these three every Principle of the Fathers is complete/perfect and continues without end.* The implementation of the Sayings of the Túwrahh is at work within all Names and their lands/bodies to bring all to the Head of Knowledge—the Number 8. All Names who have the reductive value of 8 are committed to this task within the House of Names. Other Names with the value of 1 are committed to the ALphæh as the Name of Laúwi/Levi/לוי/28/10/1 illustrates. Each Name is set by their Numbers to their respective places/spaces either Bayit, GammAL, Dallath, Hhúwa, ÚWah or Zayin. Some Names are stationed for roles to gather and to sustain the community by the Values of 9/Tæyth. Nines assist to merge the Minds into a settlement/cohesive Union. Each name is committed to its tribal number and then to the number of its name within the Branches of Thought Organization. Hence, if one is of the House of Laúwi/Levi, then their mission is ALphæh—the Unity amongst all thoughts and peoples. One functions within the House of Laúwi according to the number of their Name. Each name occupies their place by number within the Branching of Mind/Tribe to which they are called/read, which is the foundation of the unified Orders of Light.

As one is enlightened to their place in YæHúwaH they operate by the governing thoughts in their House of Dan. They bring all things to the Great White Throne Judgment within them. *Until then, decisions are made from the heart according to the powers that one allows to rule within them and to conduct their affairs.* One enters into the Hall of the Great White Throne by the white robe of Dan—fabrics of woven thoughts without spot and wrinkle. **The Light of a Name fills the fabrics of each house whereby** no dark spot or fold nor wrinkle remains in the garments of one's body. Unkept ways are as one wearing an unfit garment. We come to the Great White Throne for final sentencing of both great and small deeds, whereby the base of every deed, being discerned, becomes nullified or exonerated by one's Name. As one is *whitened inwardly* they sit at the right-hand of the Father to administer all thoughts of their Name. We appoint judges in each of our houses to evaluate what we are thinking and doing, from the deeds of ten to the increase and might of thousands [SYM/Ex 18:21].

When we are tired of being governed by bribed kings that reign for gluttony, greed and exploitation of mind, then we boot them off our thrones and **assert the powers of our Name to take their seat in succession of rule.** First, we anoint Shaul of the House of Beniyman, of the Teraysarun of Knowledge, that we learn to govern the tongue to ask profitable questions as we enter into midrashim studies of Light. Then, we fall upon our sword/tongue which conveys that we submit—fall unto the regulations of speech whereby we implement what we have learned. Then we anoint Daúwd/David, one of the Teraysarun of Understanding, who unites our house/members as one Kingdom. When our house is united we commence to fill it with the glory of our Light, whereby we anoint Yedidyahu [Solomon] of the Teraysarun of Wisdom to regulate all things within our Breath Name as the beloved, chosen, and most glorified dwelling of our Names. The narratives of the Tanach (the collection of the Túwrahh, Prophets, and Hebrew Scriptures) are not read as physical

historical accounts; rather they are procedures of Thoughts for all generations. The Names used in the narratives/parables reveal the positions and values necessary to engage the Thoughts with proper consideration via the revelation of Rúæch.

Through study and meditation in the words of the Túwrahh one becomes illuminated to know their place in the House of YæHúwaH. *One's Breath—spirited Name encompasses all aspects of their houses* whereby one evaluates every thought and deed to generate the faces of the Fathers. *The process of judging oneself is the Judgment Seat of meShich whereby one considers and submits their totality all unto meShich.* The Judgment Seat of meShich appears as one *examines the totality of their members whereby a seat is formed in one's Spirit.* When one examines one part distinct from their totality they are as taking babes to slaughter, for such would be a mass murder of innocence without due judgment. Dealing with one issue apart from the whole may lead to depression, for in so doing one forsakes the counsel of their members and the strength that resides from the unity of all parts. As one aims to come to their full measurement, one makes judgments pertaining to their deeds and thoughts and how they affect their state of life. The deeds of a house are examined as to how they affect one's totality; thereby it is *a Judgment Seat of meShich—one's fulness.* We come to the Judgment Seat of meShich as we are inclusive and consider that the wholeness of all parts comprises our totality whereby the judgment is effective in all of our lands.

*Breath carries our bodies around like the wind carries the leaves, whereby our body members are the Leaves of Dan. Your Breath is said to weigh nothing, yet it carries the weight of your body, causing it to dance as a cluster of circling leaves.* Your Breath lays you down and raises you up. Though the wind cannot be weighed, it is capable of lifting-up houses and moving giant oaks. Therefore, there is nothing we do by the body apart from the power of our spirit. Breath enables one to eat and to engage in labors. **Each labor produces the results according to the intent.** Our sex members yield fruit/results of how our members are used collectively. i.e. Sexual activities are employed with objectives unto a fulfillment, and they are often determined by how one sees or hears, etc. When sex happens on a desktop or in the back seat the pursuit is often for gratification of body rather than expansion of spirit. *Every member under the direction of spirit causes the entire house to profit. Every member under the direction of flesh causes the entire house to be in conflict.* When flesh is served the parts are swallowed up in the body. The earth opens and swallows up the inhabitants they are subject unto. As the parts serve the spirit, they are engulfed in the Light of the spirit. One who thinks upon and engages in deeds of the flesh finds that their thoughts are causing them to look for the next encounter rather than using the members of one's house for expansion of Consciousness into paths of awareness and Knowledge. **When sex is engaged for revelation through unions of spirit and for the blessings of Yúwsphah to be upon the houses, it frees the mind above the flesh.** The works of Aparityim bear the fruit of reproductions as Aparityim is set unto the faces of Nephethli. All processed through the offerings are set by Aparityim to bear the fruit of a Name in their generations. The fruit is set through the offerings of Aparityim upon the wood of Nephethli in the course of the offerings for each house, whereby each house bears the fruit of ALhchim upon their branches.

The Mind enters into a house to partake of Understanding and to confirm levels of Consciousness obtained through meditations. The body contains the patterns of Light which formed it. Through use of our members under the directives of spirit, the patterns are drawn out through the

gates/portals of the body. i.e. Through suckling the neck one enters into the unified house of another to read what is beneath the coverings/lids. The neck is a cap on the well. As the mind enters into dwellings of Light, thoughts are formed by beholding the composite order within a body whereby one *chases after revelations released through orgasm—a full giving of one's members unto an expansion of spirit*. All activities are dependent upon Breath/Rúäch via which we enliven our members and confer them as attributes of Light. In breathing upon our members, we endow them to pulsate with the fullness of ALhhim. **Every exhale dispenses thoughts upon our lands, and every inhale invigorates the members unto compiling Knowledge of Light.**

We discern in the House of Dan every attribute of our Name. With Breath, we drink wine from the navel to comprehend the origins of the Numbers and Letters woven within us until every cellular organization and space are known and confirmed for the name of YæHúwaH. With Breath we draw out living waters from the wells of salvation to raise/elevate the frequency of the seed/principles of Light and thereby affirm our occupancy in the world. By Intelligent Breath we speak according to the Principles/seeds that are drawn out, for they are now empowered through our mouth/gates.

Your Breath/Rúäch is your Teacher. All of your parts learn to breathe as One as they follow after their Teacher, Dan. Imparting the Breath of YæHúwaH into Adim is the basic act of transmitting the Lights of the Fathers into the Rings of a Seed. The ALhhim of extension kisses Adim and thereby imparts Breath within the House of Dan of a Name. The breath passes through one's nostrils whereby the Adim are activated with thoughts to fulfill their positions and progressions. With every breath we know that the sum of our being is loved and belongs to the Union of Lights. Our Breath fills us and confirms each house to be operating in their place and our place amongst others. We transmit the life of our Spirit through our words and deeds. We intertwine our Breaths which carry our thoughts and thereby affirm that we are one Spirit. Every day as we give of our spirit in the oylah, we create a path for the Fiery Breath of the Father to pass amongst our parts [SMB 15:17].

Our members learn by focused breathing exhaled from and inhaled into every part. Your Breath teaches all of your members, imparting to them Words of Rúäch through an organization of Numbers. Establishing the Numbers of our Names is preliminary for growth. The Voice of the Breath is the Voice of maShayh/Moses and the Lamb—the Voice of expounding Túwrahh and receiving the Words via a humility of Spirit. When one has their branches arranged one to another on the altar they are positioned to learn. Otherwise, with your branches out of order it is hard for you to comprehend what the Teacher is saying.

The Breath of your Name is the same as the Breath of YæHúwaH. As you affirm the Breath within you, it heals all of your parts, washes clean, refreshes you with exhilaration, and renews your strength so that your youth is ever with you. The Breath of your Name never ages nor is subject to decay. The Breath is ageless and non-corruptible. Your members may become corrupt by thoughts and desires apart from the Union of your parts; but your Breath is pure and carries the weight of your glory; however, it does not approve of your impulsive behaviors that entangle or snare you into paths of opposition to your own digressions. The burden of sin is a weight upon the mind and its parts. As you sense this weight, retrack your steps. Turn to the paths of Light coming from your Seed which opens for you daily as you give yourself totally. Walk in the Light of your Name to self-correct and realign yourself to the Spirits of ALhhim.



Dan, as the Discerner, does not permit or sanction the use of our Breath for vanity, lies, hatred speech or in any manner of use that betrays its Nature in YæHúwaH. Nor does Dan permit thoughts to quench the Voice of the Rúæch. Rather our Breath is used to bless HhaSham YæHúwaH—The Collective Name and all Names of the united glorious kingdom. When a person shouts or screams in hatred or cries out in profanity, they are subjecting the Breath HhaQudash to thoughts of vanity. When outbreaks of anger bleat from your throat, the House of Dan is small within your members and is yet to rise as a judge and leader within your dwelling. By the Principles and Values of ALhhim all things of our body are held together, and by the Collective Order of Breath all things in the world are maintained. When the mind is awakened to be a priest of the Breath, the entire house enters into phases of transformation, for no transformations occur without the active presence of a *kuwahan*/a serving priest within a house which implements the teachings of Spirit.

Via the *oylah*/ascendant/burnt offering, our Breaths intertwine and exchange with the Breath of YæHúwaH. Through the transference of smoke we bring all levels of occupancy unto the heights of Rúæch. In the *oylah* we are aligned with the Breath of YæHúwaH. We enter into the Fire of YæHúwaH to elevate all aspects of mind to be seated in the seven heavens and their thrones. The foundation of the *oylah* offering/prayers is comprised of the Fire/W4/22/4 and the Wood/r-O/34/7. In these Numbers we behold the perfection of the offering, being the sum of all things/X/22 and the means to extend all thoughts completely through the branches/wood/I/7. The Blood/ʹΔ/17/8 flows from the branches as a crystal stream flows in the stems and fruit of a plant. The Blood of meShich is not darkened; rather it is a flowing of one's life. The fire, wood, and blood form the foundation upon which the three teraysarunim in each offering of meekness, as a lamb WʹY, ascends. The Fire is of the House of Wisdom; the Wood is of the House of Knowledge; and the Blood is of the House of Understanding. Upon this platform we present the daily offering of humility/*kevesh*/WʹY/34/7. The sum values of seven denote that the offering is of our completeness, whereby we elevate the attributes of Wisdom, Knowledge and Understanding within our Name through the offering. As we live in the *oylah*, we live above forms throughout the day/actions and night/reviews. The state of the *oylah* is multiplied tenfold through the offerings whereby we acquire the Ten States of Word Verification [States of Thought envisioned and designated for our Names—Sepher MaoShah BeRashshith/Gen 15:19-21].

*The discernments and explorations of Dan are for truth—verifications of each step and deed. The activity of Dan is the means for continual progressions; however, the search is accomplished through sequential steps. The sequential steps are depicted in the oylah offerings. Outside of these steps, one may grasp for truth and find information; however, the understanding is generally void.* [For further details on the offering see BHM publication: The Daily Service of the Mishkan/Tabernacle; the Offerings of the 12 Houses].

*Since Dan determines our directions, we camp at each elevation of the offerings and from there seek the paths unto the 10 States of Verification [commonly called the Promised Land].* The steps of the *oylah* lead us into the Ten Progressions of occupation [SMB/Gen 15:19-21]. We follow the leadings of true discernment. We dedicate **our hands to reach beyond our mortality across the Yordan River—through Word Thought Formulations—to enter into the States that Verify the eternal nature of our names.** We behave as mortals when we deny our Unity or when we speak to judge another. **We live as immortals** as we affirm our Name in the Name of YæHúwaH. Since we cross through the waters of the Yarrdenn/Jordan in the territory of Gad [House of Speech], whereby there is much dependent upon our expressions and the use of our mouths in order to accomplish the sites set for our Name to achieve.

**Every shavbeth/sabbath you remember** your freedom above vanity and affirm the goal of your journey. Mark your progressions on a chart. Keep the target in front of your eyes; write down your achievements. Write your weaknesses on paper that you can burn—that which hinders your progressions; otherwise, they drag along within your thoughts and deeds. Use the Túwrahh as a road map to pinpoint your destinations as you follow the locations outlined from Metsryim/Egypt to Kenoni/Canaan. View the map daily in order that what takes place in a day can be measured with destination! In the evening, annul anything that goes contrary or adverse during the day; don't let it set into your weavings at the gathering of the spices.

THE STEPS OF IMMORTALITY AFFIRMATION  
MAPPING THE PROGRESSIONS INTO LANDS OF PROMISE/VERIFICATIONS

The ten states of inheritance/occupation given by our Fathers pertain to the **Letter Yeúwd/ו/10** which signifies our attainments and inheritances. As we receive the fruit of our labors according to the work of our hands; so *by our deeds—the implementation of thoughts, we receive the inheritance of YæHúwaH*. **The Letter Yeúwd conveys that we enter into the States of Extensions by our deeds—beyond forms of decay into a city—a gathering of lights that we are building for our members. The Yeúwd/Hand contains the Houses of Wisdom, Knowledge, and Understanding, therefore so is our habitation.** As we are in bodily forms now, what shall be our next abode? What is the next progression or skins that we shall put-on that follows this habitation? What are the concepts within these bodies now that allow for decay and corruption? What do we retain or dismiss to enter into subsequent states of residence? The fruit of our bodies is the House of Beniyman. As the fruit of a tree, so the Seed developed through our days of sojourn determine our sequel habitation. According to the frequency of Thought formulated through concept emissions, habitations are formed. As generate thoughts at the frequencies of Metsryim/Egypt below or above we move into our abode.

We do not go backwards; either we are in pause/sleeping mode or we are in progressions/making strides. One cannot deny their self nor the rites of one's Name. In that our name is within the Unity of YæHúwaH, YæHúwaH affirms all those in the Corporate House of Light to achieve their full stature. We may not know ourselves and all that lies within, but that which has been attained in our generations of Name remains, for this is the blessing of YæHúwaH. YæHúwaH blesses/increases *and YæHúwaH keeps/maintains*. Our Name continues to unfold according to the genealogies of the Túwrahh into successive stages of dwelling. **The blessing of YæHúwaH is active within us.** From the moment the Breath is imparted to us at the Adim level, via the kiss of ALhhim, the Name of YæHúwaH is set into motion within our Name to bring forth the likeness/imagery of the Faces of ALhhim. The kiss of ALhhim is the same as sending forth a spark into each SeedName. **The blessing of the Name culminates within us as all Faces/Expressions of the Fathers are brought forth within our name.** We enter into the Assembly of Breath/Rúæch—the Union of the Lights, according to that which we are numbered and named. None enters into the Union without first receiving the Rúæch/Breath of ALhhim and by giving the Rúæch to another. We are commissioned two by two. As we are united in Breath, we remain as ordained in the House of YæHúwaH. Being fully United in Breath, we proceed above former habitations. The United Breath is four faced as YæHúwaH; where-

by we see and comprehend all things from every side; nothing is hid from us. As one resolves their personal identity to be of the Collective, your Comrade of Light appears, and your Breaths are intertwined. The intertwinings of Breath are subject to leaving behind the identity of partiality. The intertwined state of Breaths receives empowerment and blessings that surpasses the strength of an individual, whereby there is a helpmate, a *gozar*, for every Name. Examples of comrades are MaShayh/Moses and Aharúwan; Aliyahu/Elijah and Elisha, Dæúwd/David and Yahunathan/Jonathan, Yahushúo and Yahuchannan, etc. The twelve tribes/branches of a Name are arranged into six pairs whereby the designated roles of each of the parts are woven strands that cannot be broken. As in the House of ALhhim, the Rings of a Name are joined as one. Each Name is fulfilled by one's united branches which flame with the lights of the menurahh. **Your Name relies upon/trust in ALhhim** [Tehillah 46:2]. When one puts their trust in ALhhim, a Name trusts/relies upon the ALhhim of their Name! One operates according to the might of their Spirit, whereby one exhales their thoughts to rise-up and inhales what has been accomplished as they lie down. You breathe the Breath of ALhhim of your spirit unto your soul's health and prosperity [3 Yahuchannan/Jn 1:2].

By the *Yeúwd*/10—the Hands/Deeds of ALhhim—the worlds/bodies are formed for a Name. The ALhhim of your Name bears the Thoughts and will of YæHúwaH whereby the Words of the Fathers are never far from your mouth. Each Name is an expressed word/message of YæHúwaH which bears the Lights of the Father. The *wudah*/veda/world is a construction of thoughts. As thoughts are extended from the Mind, they appear in manifestations. By the *Yeúwd* we enter into all states/worlds **as the agents of YæHúwaH**. YæHúwaH is Fire/Wisdom; YæHúwaH is Breath/Rúæch; YæHúwaH is Light/Intelligence; YæHúwaH is Love/Binding. Therefore, *the hands of YæHúwaH are within the extensions of YæHúwaH*. *The works of our names are ordained to carry forth the Thoughts of YæHúwaH*. The *Yeúwd*/כ is the initial Letter of YæHúwaH/אָפּאָכ, whereby all within the House of YæHúwaH is extended. The hands כ activate all within the Union of the Lights/אָפּאָ. The Union of Lights extends every thought of YæHúwaH via the *Yeúwd*/hands/כ/10/1, and formulates the thoughts through seeds/concepts. When we say, “*by the Yeúwd*,” we speak of the entire arm and hand. The arm is an extension of Mind to stretch forth the three pyramids of Light: The House of Wisdom—the upper arm; the House of Understanding—the forearm; and House of Knowledge—the hand. Thus the worlds are an extension of the Mind of Light. The Hands work through us as portrayed in the parables of maShayh/Moses and Aharúwan/Aaron to bring our members through Metsryim unto the crossing over of the Yarrdenn/Jordan River [ChameshHhaPekudim/Num 33:1; Sepher Maoshah HhaShlichim/Acts 11:22].

CROSSING HHAYARRDENN, THE JORDAN. WHAT DOES IT MEAN?  
THE OTHER SIDE OF KNOWLEDGE BY NEW FORMULAS OF WISDOM WITH UNDERSTANDING

Crossing the Yarrdenn River is going to another side of Knowledge or Mind. We go beyond our current state of mind unto other dimensions of the Light of our Names. We move into extended parameters of our Names—within constructs/numerical and word formulas of our branching mind to create a new state of habitation! As we receive from the Light of the Fathers, stored within our SeedName, so parameters of one's dwelling state changes. We go beyond the state in which we made in Metsryim. We roll off our shoulders the former body of Metsryim as we cross the great divide, known as the River of Knowledge [Yahushúo/Josh 5: 9]. On the other side we create a new embodiment to house the Light drawn out of our Seed through our sojourning. We establish the parameters for a new manifestation in accordance with the formulas of the Fathers emerging from within us. The for-

mulas have been developed at the altars—the heart of Wisdom and within the waters of our origins—those of Understanding. To enter into a new habitation one must have the formulas of Wisdom and Understanding through which all things are made [Mishle/Prov 8]. As illustrated in the Letters of the AlphæhBayit there are two sides of Light; one side is invisible—the Numbers of Light, and the other side is the visible—the Letters of Light. By new formulas of Light within our SeedName we exceed our current definitions and thereby enter into that which is becoming from our SeedNames. By the new compounds of our Numbers we form new States of Letters to create a new habitation [i.e. See BHM: The AlphæhBayit, Part 2, The Letters: [www.bethashem.org](http://www.bethashem.org)]. The extended parameters range from 1 unto 49—a seven-fold state of the Numbers and Letters of our 7 Rings/Eyes [7x7]. The Letters that now robe us are according to activated congruent Numbers formed through ascensions of our ALphæhSeed. From our beginning state unto our Taúwah/Totality, we move from one state unto the other according to our levels of transformation of mind. Expansions with our SeedName occur via implementation of the ALphæh Principal through our hands/deeds/א/10, whereby we cross over the Yarrdenn and enter into seven progressions of ten—unto 70/Oyin—the perfect State of the Unified Consciousness. We forgive or release 49 times—from our seven-fold position of completeness—lest we hold within our Seven Eyes any karma of this world which retains limited thoughts of another. We dismiss imperfections and limitations of stature that hold one to an incomplete state. Rather, we enter into the stature of meShich. No one can hold a sin against our name unless we agree to hold it there also; hence, it is with Understanding that we hold no grievances within the Eyes of our body or Name fields. As HhaQadush YishARAL—the Holy One of Israel holds not our sins within the Union of Lights, lest the Union be held to our mortality, so we forgive others lest we hold ourselves to their mortality. Hence, we release all sins, lawsuits and demands for property in this realm, whereby we are at liberty to move into the States of our WordName. We submit all controversies according to the Body of the Unified Consciousness whereby we receive mediation via the Councils of the Just and their higher Orders—those of the Seventy—to maintain a freedom from entanglements to this world to fulfill our crossing HhaYarrdenn.

#### STEPS UNTO THE ETERNAL CIRCLE OF OYIN

We proceed from the northern 42nd parameter into three successive levels of the Union of Lights, unto 49, unto 56, unto 63 and unto the 70. Upon entering into 49/13 we enter into the waters above the firmament—13/א; and via level 56/11 there is access unto the Tree of Lives—the Kephúw/א. In proceeding from one level of seven unto another, we are engaged to perform the works of that level. We may count the spaces between the Letters via increments of 1 or via the complete extension of 7. For example, from 56 we proceed unto the sixth increment/step—unto 62 wherein abides the eternal 8/א of the Principal Naometry and of the Shayh/אW/26/8. The next increment of progression—63 is the Center of the Unified Consciousness of the Ages/63/א. From 63, the next full extension is 70/O wherein is the All Seeing Eye of YæHúwaH, the Eternal Circle, aka the Ayinn Súwph/the State of Limitlessness. We are extended fully via the Hand of YæHúwaH—via 10 progressions from Zayin unto the Oyin. We move through the 10 intervals beginning with Zayin—the Tail/Word/Tongue/Penis/Labia Minora unto Oyin—the All Encompassing Mind/Centre of Consciousness which encircles our embodiment. The ten intervals comprise the dwelling of the Fiery flying serpent as it is drawn out from within us!

The Ayinn SÚwph is comprised of two words: Ayinn/אין and SÚwph/אין, rendered as “there is no end; endless, limitless,” to convey the boundless eternal nature of ALhhim. The understanding that the Divine is without end, and cannot therefore be limited, is similar to the Chinese idea of the Tao, “It is hidden, but always present.” The Ayinn SÚwph is often translated as “beyond definition via materialization.” The term emphasizes the true Unity that exists beyond all things. In Taoism for instance, Tai Chi, the Great Ultimate, is the indivisible origin of all existence, which gives birth to two forms, Yin and Yang. Thus, there are illusions expressed as a duality between these poles, male and female, light and darkness, life and death, above and below, etc. The Ayinn SÚwph is the Unity in all apparent things and yet goes beyond all things. All things point to a singularity. All things in Creation point to Ayinn SÚwph, the state of consciousness in which we all abide in the Oyin MIND. When the sides of Wisdom make a house there is space for the flow of Consciousness to enter into the house built as waters of a river fill a valley prepared to receive them. We are not limited by our bodies—the space allocated for the Light, for by receiving the Light our bodies are a pathway to return unto the Ayinn SÚwph with blessings. As long as one considers themselves according to their body of reflection, rather than that which their body is holding, they limit the Unity of Mind—the State of Oyin. Everything is within Oyin. Ayinn SÚwph is within everything and outside of everything. There is nothing but Oyin. Divine existence is indivisible as is Breath.

The Light of the Rings of ALhhim is known, as Ayinn SÚwph, an assembly of Light Principles of the Faces of Light. In that the Light is determined by Numbers there are no boundaries of time nor space. The pure teachings of the Túwrahh lead us into a comprehension and freedom from time and space, whereby we affirm that we, as formularies of Light, are not subject to any time and are capable of transforming our spaces according to the emanations of our Name. In this comprehension we move beyond the distinctions/boundaries/Metsryim of gender forms and cycles/times of outer darkness. We behold unified spirits, not individual bodies which appear and disappear within a window of the eye. In Ayinn SÚwph we have no beginning or termination, though we are born, that which is the Seed of our Name has been in ALhhim before it was sown, and the Life therein is not limited to a time or space. We are of the House of Collective Names, of the many generations of the Fathers. Should we see ourselves distinct from another, we limit the Nature of ALhhim within our Name’s collectiveness and the expressions of Unity. We are weaned from gender and types of divisions of mortality to be nursed by the Oneness of Breath. Time as days and years are not relevant nor binding upon us. There is no time unto which our Minds are bound. **We abide in a continuum of Light.** Our space is designated by our thought projections which we create and regulate. [Some consider the Ayinn SÚwph/EinSoph to be transcendent having no direct interaction with the universe.] The Ayinn SÚwph interacts with the universe through ten emanations within a designated field, commonly known as the Ten Sephyirut/enumerations—literally through spirals of Numbers of the Faces of the Fathers אִין. These 10 intervals are within Oyin of a House. As a spiral the thoughts in Ayinn SÚwph connect to those Numbers within us whereby the Thoughts of Light take resident in the bodies prepared. As the thoughts rise through the intervals, the Faces of the Fathers become apparent within us.

The Ayinn אִין —the inherent unseen woven thoughts in the Seed of the Neúwn are employed or activated unto a fulfilled extension as a deed. Thus the fulfillments of Túwrahh are the Thoughts of Light fulfilled into deeds. The Thoughts of Light are read as words which are of varying interpretations. The inscriptions of Light, known as the ancient Hebrew prototype/Phoenician/ancient Arabic, devolve from a common sacred geometry. As the intersections of this geometry register within us,

the oracular emerges in its fullness to be expressed/interpreted by deed, at which level the language of mystery becomes science. Science is an analysis of that which appears by words—what is spoken. As we fulfill the Words of the Fathers we enter into the *science of life*. In that the Fathers give all things completely—unto the tenth state of fulfillment, the Fathers are termed as “The Poor” amongst you, for they give all things freely! The Unifying Principles 4 of the Fathers radiate towards us by the structure of their unified faces— 7Y#̄/súwph. The calculated thoughts are determined as to that which they accomplish. The calculations are transmitted to us Numbers to Numbers through which we come to know the Mind of the Fathers unto bearing their Faces. As the intervals are set for each house in the oylah—state of full giving, we are positioned to receive the enumerations of Light fully given. The Ayinn Súwph is passed from the Fathers through Bayinah which appears humble in all states of Being whereby the Thoughts of Light are transmitted without distortion. The Ayinn Súwph interacts with the universe through the organization of Numbers, whereby there is no limitation of that which is in ALhhim and whereby the expressions of Ayinn Súwph have no boundaries or terminations. The Ayinn Súwph is not bound to any time nor space, of which we are and by which we have Being.

### The Rings of Breath and The Garments of Light

Ten circles are formed as we exhale Breath. When the thoughts of YæHúwaH breathe, space is shaped. The Earth is filled with every projection of Thought. The first circle of Wisdom, formed by the Breaths of joined ALhhim, is laid down upon a square of four sides of Light. As Wisdom rises the walls of Understanding are formed and the rings within them. The Breath encompass/fills the walls with Understanding whereby it is said that Understanding is at the side of Wisdom. The base rises ten degrees or ten steps which signifies a full extension/7. With each elevation of Teraysarun Thought, the Breath surrounds the parameters, forming the Oyin Body, a segments of 10 parts. The ten elevations are the full extension of Unity, as one/1 is the reductive value of ten/10. The union of the inner Fire and outer rings of Breath are the foundations in which are the fulfillments of the worlds. The Fiery Nature and the rings of Breath are depicted in the onion bulb, a composite of ten circles. As the onion is opened, the fiery smoke rises into the eye/Oyin whereby the eye of the onion and the eye of the peeler share as one. The eyes and the onion are of the same frequency whereby the eyes are affected rather than the ears. As the onion sheds its tears/fluids when it is cut so the eyes cry. The fiery smoke within the Oyin/onion burns within the eyes as the Fire of Wisdom within the layers of the onion skins.

The onion is a circle of 360°. In 360 there are ten, for what follows the 36 is the O which depicts the Oyin Head over the 36/9 parts of the Oyin Body.

We breathe, and the breath enters and surrounds our members. The Breath forms a tabernacle/teraysarun structure creating a metamere circled body as a chalice of ten circles corresponding to the ten rings around the trachea. We exhale and inhale

W+X = 700: the 10th of Oyin/70/O is perceived in the midst of the Shayin Taúwah

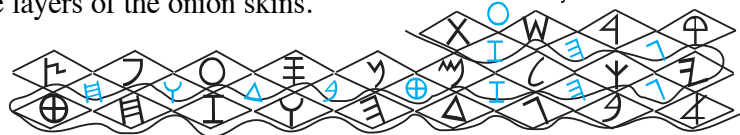

The 9 sets of Letters unto Conscious Mastery—the pillar of Bayit, Tayit unto Oyin—the Consciousness of Dwelling Crowned. The 11 spaces amidst the Letters convey the congruent value on all sides, the sum of the spaces is 56, the quest of Unity, with a congruent value of 11 and/or 2—the Bayit/resident state of the Tree of Life/7, the value amidst the Bayit and the Kephúw/7 is the Tayit/9/Consciousness of Residence with Four Heads/⊕ in which are the Qúphah/⊕, Rayish/4, Shayin/W, and Taúwah/X, points of the crown.

by measures. When we breathe upon another we place a circle/Oyin around them. As our breath projects and carries the thought base of our Name, we create new habitations. Through breathing we merge Wisdom and Understanding or Fire and Intelligence. **There are 7 levels and 10 spaces/generations/stages/circles within each 7 levels whereby we abide, move, and have our being in 70/Oyin/circles.** There are no more or no less. Seven levels denotes completeness. Count the spaces amidst Zayin/7 unto and including the Letter, Oyin/70. Discern the factor of Yeúwd/10 in their midst. The ten spaces are the ten states in which we enter to perform the deeds/activities of our Name from our tail to our head. One enters into the lands as the head of the Seed begins to draw itself out unto its tail. As we draw out all in our SeedHead we form the serpent of Dan able to ascend upon the pole for the healing of the soul. There are no accumulation of years in a linear fashion nor time-line; all movement is cyclical. Seventy is the complete/7 multiple extensions/10 of Thought. **As YæHúwaH imparts established thoughts, the levels of deeds are distinguished for 70 spirals. In the 70/Oyin there is no past nor future. All levels and spaces in which we move are encircled thoughts of YæHúwaH like the unique fingerprint. The hand marks our identity as an embodiment of concentric rings of Light.** *The thoughts that we project are the garments that we are walking in each day. Each category of thought is a garment for the ten parts of the Oyin Body. As the thoughts are sent forth by the Breath, there is a misting of Breath unto weaving a fabric which covers our dwelling. The weavings are comprised of like/associated thoughts according to their number base. We do not to bind together thoughts of different kinds as wool and linen or any mixture of threads of different values. Some strands are woven of associations of Wisdom and Understanding and some are three parts—with Knowledge which are difficult to tear asunder.*

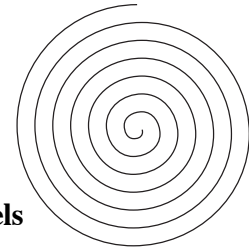

THE COILED SERPENT OYIN WITHIN THE HEART OF CHAKMAH

In abiding with the 70—Understanding of Wisdom, we dwell within the Spirals of Ascensions. **Oyin is with Wisdom** from the foundation unto the full extension. We release Oyin from Zayin unto Shayin—unto the glory of our Names. The Assembled frequency of Light governs in Bayinah. The Eye/Ayi/O of Bayinah is amidst all Letters and is heard in the Names of the Letters: Bayit, Zayin, Chayit, Tæyth, Oyin, Rayish, and Shayin.

The Breath of YæHúwaH is activated in a Name when one breathes through their rings of Wisdom, then through their rings of Understanding, and then through their rings of Knowledge. As one breathes collectively, what is within a Name passes through the exhaling arches. The Breath is gathered as one inhales into the depths of one’s houses whereby that which is of spirit lodges within our parts. As our Breath enters into our parts there is the Consciousness of our Name from the mind to the sheol [Tehillah 139:8]. The circling motion is of Bayinah who emerges from within the Name. The Governess of the Light/Bayinah (symbolized by the Moon) provides definition, the means to reveal and comprehend all in the Name. The Breath, as it exhales, forms a mist of thoughts around us. **This mist is commonly referred to as a thick darkness/𐤇𐤅𐤀𐤁— a compound/layering of Light/a spectrum of colors by degrees.** As

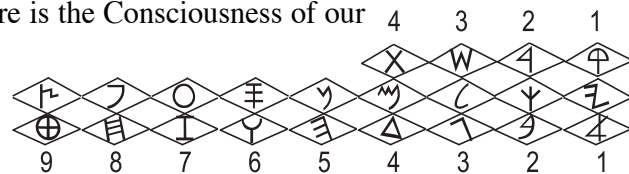

The 13 Pairs of The Name of Yahúwah and the 9 Thread Types of the Serpent Oyin Body: 5 two ply threads and 4 three ply threads. Each thread type is comprised of the same value/number base. i.e. The thread Chayit and Paúwah are comprised of Chayit/8 and Paúwah/80/8, both being congruent with the values of 8, a garment for the seat of the loins in which is Eternal Life.

Breath comes forth to make statements, the thoughts of Light in a Name are projected. In speaking we enter into the compound of the mist of layered colors. We draw out Light strands woven in our Seed by our words to verify the Names of ALhhim which has assembled together to form our Seed. With each saying, a compound of mist is as formed as the colors of our Name are projected through words. Into the mist of darkness we enter to fulfill the Words spoken [Sepher Yetsiat Metsryim/Exodus 20:18]. The projection of our Name carries forth statements by which we live and move. As we project the entire Word code of our Name, we step into these projections which become our garments. The perfection of words leaves no tear in the garments. When one projects their thoughts into words a type of garment is made congruent with the words spoken. Each garment type is relative to the Names of ALhhim. Projection of strange thoughts with the clean—those with Adim and Núwach, create an estranged body of mortality; whereby pure thoughts of Light create immortal dwellings.

One of ALhhim speaks the Ten Words and thus enters into the ten states of Light. This is conveyed in the writings when maShayh/Moses speaks and then enters into a thick darkness—in compounds of light. Through entering into the Words one puts on the garments of the Names of ALhhim. As we enter into the Words of YæHúwaH, we move from one stage of the Wilderness—a drawing out of Words—into other levels of Word progression with expression. This movement is according to the Words of Wisdom being extended unto Knowledge; what is in the base rises to the crown. As we move into the Thoughts of YæHúwaH, we put on the Mind of YæHúwaH. The Words we speak create a house in which we abide with ALhhim. In this manner the Word becomes flesh, but not a flesh of corruption. The Word of YæHúwaH endures forever. **We behold the Word** manifested, better stated the Word *expressed*, which is the meaning of becoming flesh/ **AW**—*a development/formulation of Fiery Thoughts*. Upon speaking the Words of YæHúwaH and entering into them, we clothe our bodies with the expressions of the Eternal Word. As a result of projecting the Words of Light unto a mist of darkness, the fiery serpent is clothed with skins. The threads that comprise the garments are of two ply or three ply according to the Numbers of the Letters woven to form the serpent's body [Qoheleth/Ecclesiastes 4:7-12]. The Number of ply in each thread arranges the thoughts into a fabric which comprises the body of the fiery serpent.

Darkness is formed by Light compounds. The Light, prior to being spoken, is layered and distilled to be Darkness—the gathering of the Union of the Lights. Out of Darkness/Bayinah comes the Light of the Day/Chækúwmah whereby Light appears through utterances of ALhhim. The composite layers of darkness release in measures—through twelve gates—the distinguishing colors that pertain to the organizational flow of Thoughts each day. Each gate corresponds to one of the twelve hours of a day, each being 15°—an emanation of the Name Yæhh/ **אב**. Queen Bayinah, who dwells inwardly, becomes the Head of the assembled parts and encircles all within the Assembly of Lights each evening.

Which is greater, the Light of Chækúwmah or Bayinah, the sun or the moon? *The One of ALhhim considers/thinks upon the totality of the foundations of the flowing great Lights* [Sepher Maoshah Bereshith 1:16]: the totality of the flowing great/nurturing light to govern the day, coupled with the totality of the flowing small/ **אב** light to govern the night and the stars. The concept of small pertains to that which reduces or humbles itself—not self-exalting, whereby it *governs the heavy mass of all layers of thoughts and the stars—the extending fields of Knowledge*. The stars/kukavim serve to extend thought into fields of Knowledge regulated by Understanding. A star serves to expand Wisdom and Understanding unto Knowledge. Knowledge contains multiple seeds, as seeds



STATES OF RESIDENCE	The Letters	The Garment Type	Thread Value
The Yevusi/לַיְבּוּסִי	I O	strength/might/IO	7
The Girgashi/לַגִּרְגָּשִׁי	Y	a lid/to conceal/thankfulness/יָפֵי	6
The Kenoni/לַכְּנֹנִי	Y	splendor/kindness/eminence/wail/אֵי	5
The Amori/לַאֲמֹרִי	X	longsuffering/love/אֲמֹרָה	4
The Rephaim/לַרֵפָאִים	W	to whiten the heart, gentleness/לְבָב	3
The Perizi/לַפְרִזִּי	4	bearing/upholding/chariot dress/פְּרִזָּה	2
The Chitti/לַחִטִּי	P	mercies/compassion/defense/חֵן	1
The Kadmoni/לַקַּדְמוֹנִי	H	truth/affirm/citation/קָדְמוֹנִי	9
The Kenizi/לַכְּנִזִּי	F	inspire/trust/broiderwork/חֵן	8
The Kayni/לַכַּיִנִּי	O	strength/humility/power/IO	7

The serpent, viewed from the West side, poised to shed its skin and compose its garments. The garments are configurations of thoughts that correspond to the Ten States of Residence, proceeding from strength to strength/IO.

that are scattered within a fruit, so are the stars. According to multiple thought branches or clusters of concepts the stars are flung into space. Each star is a seat of knowledge. The stars form a crown as Seeds arise from the base unto the apex of our thoughts. Open an apple; see the crown of seeds inside. From whence have the seeds come? They have formed by strands of Light congregating within the fruit. Via humility to Chækúwmah/Wisdom—impartial unions, Bayinah regulates the mass that Chækúwmah makes and also regulates the stars—the vast projection of Knowledge. Thus, which is greater? The answer is in these words: “The One of ALhhim considers the great light to be joined/coupled with the small light; hence, there is no distinction between them, for the Light is One. Night yields to day, and day blends into night. Via the Lights, the messages of YæHúwaH are given [Tehillah/Psalm 19:2-4]. We receive the messages of Chækúwmah and Bayinah in all things. The encircling patterns in all things affirm that all is One and belongs to One Breath. The United Queens of night and day comprise the Unity in the Name of YæHúwaH. The following illustrates the Names of Bayinah and Chækúwmah in the Name of YæHúwaH.

### The Values of 70/Bayinah

**Seventy is greater than any number.** Seventy is greater than 80 which are the mouths of thought, greater than 90 which are the upper branches of thought, greater than 100 which provides a cap for thought, more than 200 which is the Head of Thought, more than 300 which is the Fiery core of thought, and yes, more than 400 which is the summation of a thought; **for 70 surrounds all values/numbers and encompasses them within the embracing arms of Understanding.** Thus Wisdom is loved by Understanding which surrounds Her, and Wisdom loves Understanding to abide within Her and to reveal all unto Her. **They abide in love—as One Light, in that nothing is hid or**

**kept unto oneself. Bayinah and Chækúwmah recognize their connections/bonds of Light to carry and share all things in Unity.**

Every position in the 70 leads to a nearness to YæHúwaH. Outside the Oyin circles/the Schools of Understanding—known as the Schools of the Priests—are ideas of estrangement, specialness, possessions, greed, uniqueness, saving one’s self, seeking recognition, all of which leads to wars, conflicts, disputes, and blocks the Light passing through the Teraysarun in each gate. **Every trait accepted that is outside the Oyin spirals blocks vision to that which is within.** Judgment upon others blocks one’s vision into Totality. Until we see all as one, we see only in part. However, as we lay aside concepts of estrangement—strange alhhim, that which is inside becomes accessible to us.

*Why is it that the Oyin is the Center of Limitlessness and all possibilities?* The Oyin keeps all the deep things of Wisdom and swallows them up to create the Well of the Waters of Eternal Life. In other words, Oyin surrounds all things and cherishes all things of Wisdom. She is the House of Understanding, composing the Inner Court of the Laúwim/Levites. Thanks to YæHúwaH who reveals the paths of Oyin as noted above.

“Behold, I send my messenger before your Faces, *to keep you in the Derek/Way and to bring you unto the Maqum/Place to verify my hospitality—where I have prepared for you to reside* [Sepher Yetsiat Metsryim/Exodus 23:20].

Upon seeing our habitations in Oyin, are we yet content with things in the world which are fading? Glory to the Fearful—Wide Eyes and Merciful, Compassionate Name, for by the fear—the opening of the eye unto YæHúwaH—we see the Path/The Way before us. As Yahushúo—the Voice of Shayin Oyin of the Faces states: “You know the way that I go” [Yahuchanan/Jn 14:4].

### The 10 Thought Projections for a Name’s Dwelling in Light Each State is a Fabric/Garment

By the *Yeúwd/hand* of maShayh/Moses and Aharúwan/Aaron consciousnesses are brought into 7 Schools of Thought—the 7 Wildernesses unto a river—a flowing of Knowledge—the Yarrdenn/Jordan. By the *Lammæd/Feet*—Progressions of Thought of the priest of Aharúwan and the family of Qahhath/Kohath who carry the Ark, the camps are taken across the Yarrdenn into the Ten States of Inheritance: **the Qayni, the Qenizi, the Qedmuni, the Chitti, the Perizi, the Rephaim, the Amúwri/Amorite, the Kenoni, the Girgashi, and the Yavúwsi/Jebusite.** These ten Names correspond to the ten fingers on the hand and the ten extensions of the Oyin. The ten Names of these lands are States of Thought on the other side of the Yarrdenn, as one passes through the lands with Knowledge. Those who cross over from one state to another are called **Hebrews**. A Hebrew and one who speaks Oovri/Hebrew are those *who reveall/read the meanings in all things and cross over to the other side of Knowledge.* The take-off point is to depart from exterior projections and to enter into Word constructs and the parameters of Knowledge. The Path is provided and directions are mapped by those who point by the hand/10.

*The Ten States are the destinations of our journey, the goal of our passing through Metsryim/Egypt, the intentions/scope of our studies, and the acquisitions of our labors.* The path

of the upright ever expands for those walking in the commandments—illuminated Orders of ALhhim. We have a glimpse of these States of Occupation as we commence our journey. They are set before the eyes as they are appointed to our Seed Name in Avrehhem. These 10 States are the lands set in our Seed to be a dwelling of all Names even as the body of the plant is set in the eye of the Seed. The Ten Lands surround the Name of YæHúwaH as land surrounds a city. In the heart of the city is Bayinah. Around her are ten pieces of a pie, comprising ten pyramids of thought that are assimilated as ONE, as 1 is the reductive of 10. Why are there not twelve bodies, one for each of the tribes? The twelve are not the body, but are the ones for whom the Body is designed. Together with

Notice: Bayinah refers to Understanding, Chakmah to Wisdom, and Dao to Knowledge. The values of these Names are found within the Name of YahúWah via mathematical formulas of the Letters comprising YahúWah. Via the Numbers derived in the equations, the Name of the Bayinah, Chakmah, and Dao appear. For further information on these Names, consult the BHM Torah Dictionary.

The Names of the Queens: Bayinah/ 𐤁 𐤓 𐤅 𐤓 and Chakmah/ 𐤁 𐤓 𐤅 𐤓  
 with Dao/ 𐤀 𐤁—the Prince/Teraysaron of Oyin abide  
 in YahúWah/ 𐤁 𐤓 𐤅 𐤓

𐤁 𐤓 𐤅 𐤓  
 5 6 5 10

The balanced equation of YHWH is

𐤓 + 𐤁 𐤓 = 𐤁 𐤓 - 𐤓

𐤀 (13) 2 + 5 + 6 = 5 + 10 - 2 (13) 𐤀

The value of 13 is comprised of 𐤓 𐤅.

The combined value of two Hhúwa/ 𐤁 and two Bayit/ 𐤓 render a Neúwn/ 𐤓.

The combined value of YHWH is 26, comprised of 𐤓 𐤅.

The Names of Bayinah/ 𐤁 𐤓 𐤅 𐤓 and Chakmah/ 𐤁 𐤓 𐤅 𐤓 with Dao/ 𐤀 𐤁  
 are in YHWH 𐤁 𐤓 𐤅 𐤓.

The drawing out of the value of two in YahúWah, is the basis for the pairing of Names in the House of YahúWah. Via the Hand/ 𐤓 extending Light/ 𐤁 there is a drawing out of Unity whereby all things are perpetually shared between the Names of Yah and Wah. Names are drawn out in pairs and thereby sent forth two by two. The balanced Number of 13 pertains to the list of Names in Sham: 13 of Sham and 13 of Sham's extension, Yoktan, to comprise the 26 offspring/attributes of a Name—the value of YHWH/ 𐤁 𐤓 𐤅 𐤓/26 [Sefer Maaseh Bereshith 10:21-29]. The reductive value of 13, being 4/ 𐤀 is the Teraysaron structure of the House of YHWH, the initial letter of Dao/Knowledge which are the branches coming out of the trunk/midst of Bayinah. The value of the Oyin/ 𐤀, being the 16th letter, is the combination of the HWH/ 𐤁 𐤓 𐤅 in YahúWah. The Name of YahúWah is read as “the Hand of Oyin” from which the Ten States of Oyin appear. The Ten Lands are the House drawn out of the Name of YahúWah. From the values of The Name and their formulas, the letters of Chakmah/ 𐤁 𐤓 𐤅 𐤓 and Bayinah/ 𐤁 𐤓 𐤅 𐤓 with Dao/ 𐤀 𐤁 are in the Name of YahúWah/ 𐤁 𐤓 𐤅 𐤓. Thus when one speaks in the Name of YahúWah, they speak the words of Chakmah/Wisdom, Bayinah/Understanding and Dao/Knowledge.

the Oyin Body of 10 parts + the 12 houses, they are the collective 22 of ALhhim. The Túwrahh begins and the Túwrahh ends with the Names of Light and their lands: “In the beginning/Mind of Covenant are the heavens/Names and the Earth/states” [Sepher Maoshah BeRashshith/Gen 1:1]. “This is the Land which I have swear to Avrehhem, to Yetschaq, and to Yaoquv, for a saying: To your Seed I have given it” [Meshneh Túwrahh/Deut 34:4]. “And from The Name of YæHúwaH, the Offspring of YishARAL proceed with consciousness of the Oyin’s Totality/the aúwt/epoch of continuum. The Names of Fire proceed to form their states or domains according to their tribes/branches and family/faces. **And they arise from The Name unto their inheritance.** In those days when one comes unto their land, there is no king in YishARAL; everyone of The Fire is Upright/אמלא. **United in Oyin/אלוה, one is initiated to perform.**” [Shuphetim/Judges 21:24]. To say that there is no King is a saying of Dan, of the Shaphat/Judgements, regarding all who come into the chamber of the Queen Bayinah. Those who come into the Queen’s chamber are dressed to perform what is upright—as a Shar, a prince, whereby they affirm that they are of the United Order/AL, and hence of the Rule of Light.

As we consider that we are the Offspring, and affirm by our faces our Fathers, then *we are heirs to all stated within the House of YæHúwaH from THE FOUNDING PRINCIPALS. Together, the Ten States of Promise/Verification are the most choice inheritance, the splendor of splendors, the lovely lands, and the beauty of beauties. These lands are appointed to Avrehhem and to the Seed, who affirm the Letters and Numbers of their Names by appearing in the lands.* According to the words of the Prophet YirmeYahu: “In those days the House of Yahúdah walks with the House of YishARAL, and they come together out of the land of the north (via Dan/judgment/discernment) to the Land that I have given for an inheritance unto your fathers.” And I say, “Qualify yourself. I place you with the Offspring, and I have given you a pleasant land, **a heritage, the splendor of splendor of the nations.**” And I say, “You say, My Principal/My Father/אלה you call me by instruction—as one taught, and therefore, you follow after me and will not turn back.” If you commence to read into the ALphæh Bayit/אלה to the 10th Power—the Yeúwd/אל, you become a disciple, and there is no turning back to another land/state. Once you have orientated your eyes to your Father, your course is set. For when you begin to read all that is in the Name of YæHúwaH, there is no desire for any other dwelling state [YirmeYahu/Jer 3:19]. “As One of ALhhim is with Vision/אלה, the totality of the hashemim/Names are coupled with the Aúrets/land” [Sepher Maoshah BeRashshith/Gen 1:1]. *The land of Names is the collective state of the ten lands of the nations—processes of Mind. The vision of YæHúwaH is transposed into our consciousness; we follow there after.*

While there has been a negative slant cast upon these ten states/nations through translations, it is never stated in the Túwrahh that these ten states are to be destroyed as some have rendered the texts. On the contrary, **these states are to be possessed as our inheritance! As they comprise the Oyin Body, in them is the Pearl of Great Price** [Mattithyahu 13:46]. To destroy what we are to receive is anti-theoretical to the promises set before us. We are unfolding what is in the Seed of our Names pertaining to these ten states in order to enter them as our lands of inheritance.

The Lands are the Extension of the Mind of Reshun 5:5—  
being Ten for us to Enter and Dwell.

Being a construct Taúwah/X of 10, the Lands are the Letter Taúwah to the Tenth Power—an extension of Totality.

## The Land of the Qayni Thought Process

1. **The Qayni/Kenite/קניזים/State of Zayin**, corresponds to the right thumb, a means to open and carry a thought.

The Qayni lands are the initial states of transferring what is in our Seed unto a State of Occupation. This state comes out of our SeedName through forming the Rings of our Name. The state is filled with all attributes of the Lights of the Fathers woven in our SeedName. By giving all of our Name, through the oylah offerings, we create the State of the Qayni to contain all predestinated for us to inherit. From the Qayni to the Yavúwsi, the ten lands within our SeedName are entered into whereby the glories of the Fathers become manifest.

As with nature, we commence to gather with the Zayin, the wands of Aparryim and Gad. As we extend ourselves from the zygote base, we create rings in which we gather from our SeedName. Should our rings be as pockets with holes in them, what we observe slides through them whereby the growth is nil [CHaggai 1:6]. The Eyes of our Spirit are as purses into which we gather from the emanations flickering from our offerings. i.e. We use the tongue of Gad/Zayin as a knife, to open the keveshim offerings. Through each opening of the kevesh, the seven rings of our Name are formed for the night or the morning. **As with the givings/offerings of a seed, a body forms.** Hence, the Qayni state is made through the offerings, commonly called *the pathway of the lambs*. The way of the Túwrahh is the path of the upright [Yeshoyahu/Isa 26:8]. One who seeks to climb-up—make an ascension into enlightenment through any other way other than through the offerings of the sheepfold takes away from their own habitations [Malachi 3:8]. **The Túwrahh/Torah Way is the Collective Way in all things.** Every law is for the honor of the Collective. We slay the offerings with the sword of our mouth to appoint our members unto the service of the Collective. When one seeks to serve ALhhim and their neighbor as one's self, then the Túwrahh opens unto them. The secrets contained in the Words flow into one's rings as gold, silver, and copper according to one's obedience and faithfulness. Via our words of surrender and dedication to Unity, we open the throat/neck of the kevesh offering, whereby we have access into all realms of Wisdom, Understanding, and Knowledge. This is the dedication of our tongue to speak only for learning and to advance the concepts and values of Rúæch. We do not repeat something that was heard for the sake of repetition, especially if what we heard violates a Name or an avenue of progression. We affirm that our tongue is like the right hand thumb that hangs loose at our side which can open a jar—even the vessels of our clay bodies—in which we discover the fullness of the Túwrahh. Our tongues are sharpened by the Fire of Rúæch whereby we can take hold of any state as one skilled with the sword. We affirm our tongue to be a refiner of gold, silver and bronze/copper; hence, only words and thoughts that pertain to the precious values of Túwrahh Principles are at our

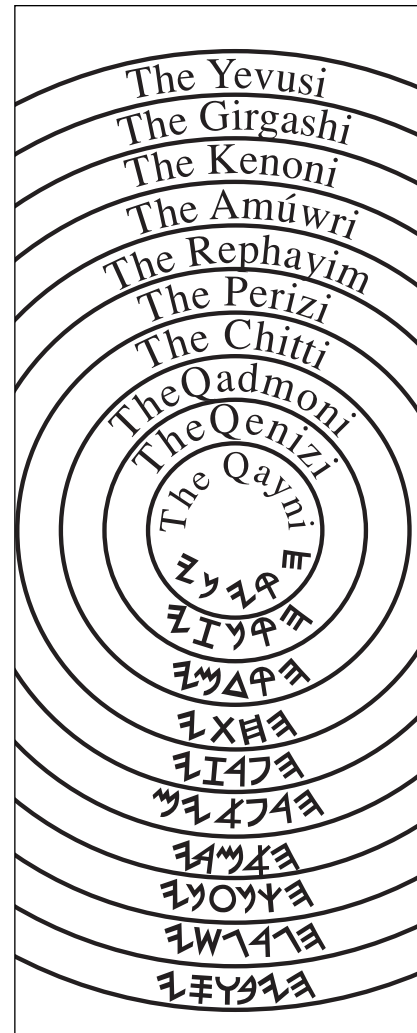

lips. The Qayni are noted for their copper fields in particular, which pertains to those mining out Knowledge. They are called the instructors of Knowledge [Sepher Maoshah BeRashshith/Gen 4:22].

Throughout the scope of the Tanach writings, the Qayni/Kenites dwell in the South, within the lands of Shamoúnn, RAúwaben and Gad. Those amongst them having discernment of speech. They abide in Sela/סֵלָא, meaning a rock and in Punon/פּוֹנוֹן, meaning to hesitate, pause, and turn in the direction of the sound as one would listen for further insights before responding [Chamesh HhaPekudim/Numbers 24:21-22; 33:42-43]. Both Sela and Punon are within the land of Shamoúnn **whereby Knowledge becomes the regulator of hearing**. How do we hear? The answer is in the Name Sela: we listen to structure understanding and to comprehend that all sounds belonging to One. We hear to affirm the discernment of Dan, that being of Wisdom. We hear every sound and thereby comprehend its significance in Unity.

The Qayni are also noted for accompanying Yahúdah and thereby following after and in accord with the comprehension of values [Shuphetim/Judges 1:16]. They are positioned with Yahúdah, **for as they open the throat of the kevesh all values within the house are drawn out**. Those near to Yahúdah and the House of Daúwd are called the scribes, for they grant insights into all numbers and value documentations within [Dibre HaYamim ALphæh/I Chronicles 2:55]. Thus it is of the Qayni state that information pertaining to the numbers in this study have been derived. Their scribal activities stem from the House of Rechab, meaning from the chariots/the merkavah, through which we are transported nightly through the stars—the seats of knowledge. From the Knowledge granted, we write and document our findings for preservation and **to structure the expressions of thought**.

The Qayni assist YishARAL to overcome. This thought process is set in the parable of Jael/Yaael, wife of Heber/חֵבֶר/associations to overcome Sisera—flighty/roaming glances/observations. Yaael, meaning to achieve ascendancy, is paired with associations/Heber. Being of the Qayni thought, Yaael takes hold of/grasps the tent peg of Wisdom to regulate vision and be dedicated to oversee and observe our dwellings in Zebúwlan. Via the tent peg of RAúwaben into Zebúwlan [Shuphetim/Judges 4:6] one overcomes the deafening process [in Harosheth, Shuphetim/Judges 4:2] caused by the instability of the eyes. Yaael—the force to implant associations—pierces the thought of roaming glances with the tent peg/cord of Wisdom whereby the eyes are fixed. The tent peg sets the eyes to focus on the occupation of the Temple, whereby one hears what is in the Temple. With dedication to the House of YæHúwaH there is hearing to affirm our dwellings. The four pegs of a tent are cord connections whereby all aspects of *knowledge become stitched together*, and the bonds of Names are secured/defended.

Via the Qayni we evaluate all thoughts and grasp the knowledge how thoughts are associated and paired. We know likewise how to join thoughts together into statements and use knowledge to achieve progressions. The Qayni lead us to consider what every thought is connected to and to discern from which seed/concept of light or darkness the thought belongs.

Perhaps most familiar of the Qayni land is Yethro, the father-in-law of maShayh/Moses. Yethro is of Midian, indicating that **the Qayni are of the subconscious level of thought which rises up to assist us in our missions and directions to provide counsel and how to order our affairs**. Via this base of knowledge we are diverted from destruction and calamities as noted in the counsel to depart from the ways and faces of Omaleq/Amalek [ALphæh ShmúwAl/I Samuel 15:6].

Whereas most translations deal with these 10 Names of the lands of inheritance as forces to be cast out and destroyed, upon examination of the verbs, the meaning is clarified that **we are to thrust out, from within us, these states of progression**. As seen in the functions of the Qayni, they have been lodging in our midst! In the days of the harvest of YæHúwaH, these fruits/expressions of our Yeúwd/Hands, are gathered as the precious grain from the chaff. In days of our transference out of Metsryim, we bring these nations/processes forth with power and possess them—entering fully into their names and operations of Life, for **in them are the extensions—the ten of our Name**.

Where the translation occurs in English “to drive out/W<sup>4</sup>,” the root of the Paleo word/W<sup>4</sup> means “**to possess, inherit, and bring together in one.**” We are commanded/ordered to join all nations/thought processes in one, together with the Branches of our Name.

Via Understanding we unite the two parameters or sides of Thought formed by the Letters of the square of Lammæd—**the upper row of Letters, Semek to Shayin, are joined to the bottom row of Letters, ALphaeh to Zayin**, whereby we integrate/∩ Knowledge/4 with Wisdom/W [Chamesh HhaPekudim/Numbers 33:52]. The sum of Knowledge and Wisdom are 154 [16+18+20+22+24+26+28=154], which are the Values of Saúwd/Sod—the garden of mysteries containing the seeds from the four sides of Light. As the Seeds of Light are sown into the foundations laid for them, the Garden of YæHúwaH is planted to be watered by the rains above dispensed by the 15 Fathers of Semek [SMB/Gen 13:10; Matt 5:45]. The types of rains come from the Fathers including the rains of Fire and Brimstone which comes from the Fires of Shayin and the sparks of the wood of Semek. The rain of Knowledge streams from the House of Dan in the Shayin-Semek Ring of ALhhim. As the rains of Knowledge come down to the earth, the YarrDenn/JorDAN River is made to distinguish the Lands of the OYIN-ZAYIN—the lands of 77. The Values of 77 are the measurements of all spirits as they take-up residence/a body for all things have a head O/70 and a tail I/7. The 77 are in the midst of the Letters from Neúwn to Chayit: 8+9+10+11+12+13+14=77 IO. The Yarrdenn/JorDan ∩<sup>4</sup>∩ river is called after the Name of Dan—one who gives the Knowledge of Shayin-Semek. As the Kuwáhnim/priests position their feet into the flow of the Light of the Fathers, they bring the revelations of Dan to the people whereby they cross over into the lands of Oyin-Zayin.

The sum of the four sides of Light are read by their Numbers: 21+7 =28 and 15+1=16. The sum of the 4 corners are 44, the solidarity of Tsuor—The Rock. As the corners are joined 21:1 and 15:7, the TaúWah appears, forming the Numbers of 22+22. These also yield 44 which maintains the solidarity of the Letters. These two measurements of 44x2 are 88 which are of the 2 8's of the 28 ALhhim. As one unites their sides and their corners they form the Consciousness of their Names 88/16/O. The consciousness of the 28 ALhhim gather their Thoughts from four sides to create the Garden of the Leaves of Dan/GOmorrah with Saúwd. **The Values of 154 are the sum of 10/1 whereby all Thoughts of Fire are counted as one.** As we speak according to Unity of the Fathers, there are no words of deception nor division; rather, a pure language is upon our lips. **The words of spirit are one.** As our speech/lips are of the foundations of ALhhim, then Understanding flows from the midst of our Words as the Thoughts of Neúwn to Chayit flow in the midst of the Letters of ALhhim. What we are thinking is in agreement to the foundation whereby our thoughts are real.

*In uniting the base to the crown, the Wisdom in our Names possesses and inherits all extensions and places prepared for our Names to dwell in with liberty.* We abide in a harmonic and faithful state as the ones of ALhhim are in the midst of the Fathers. The Union of all Letters into One verifies that all branches of Knowledge and the processes of Light belong to the foundation of Wisdom. The sum of the sides and the parts are held together by Understanding. This Union of ALhhim convey that **every branching of Mind and every process of Life within us know full well that they are forever joined to their base of Wisdom in function and expression**, and thereby the houses or souls of our Names are healed from every transgression and violation that the branches and the processes committed in their days of separation. This is **the great healing of the nations** and the absolution of mortality, or as called, “the swallowing up of mortality,” for it is no more! The same is called the Days of Gaulayh/Geulah אלאה—the healing of the diaspora [YechúwzeqAL 11:14-20, Zekkaryahu 2:14-17]! [These are some of the most important paragraphs in this document. Re-read them until you comprehend them fully and are prostrate before the Faces of the Fathers in Shayin-Semek.]

The sense of *bringing the ten processes of thought/lands/states forward from one's Seed* is further stated in the Túwrahh “to cast them out/אצא,” whereby we are **“to cast them from within our SeedNames to be our camps.” “And to your Seed I appoint these lands”** [SMB 12:7]. **We liberate—shake them from within our fruit/centres of soul whereby they become active states of Name to bear our fulness.** We oust them from within our Seed like an acorn draws out the various parts of the tree that it may enter into the land fully. We may go after them and possess them through our immortal nature [Meshneh Túwrahh/Deuteronomy 7:2]. In another passage the verb/אצא, translated “to destroy them/אצא,” is better rendered **“to loose them”** whereby one may explore their every detail and the functions/processes of Life within the Seed [Meshneh Túwrahh/Deuteronomy 12:3]. The verb/אצא, is also used meaning “to destroy,” which conveys the sense “to mark and designate as one consecrates a process” on behalf of YishARAL.

We are not to “intermarry” with these nations—that is we do not subject the Name unto the processes whereby the name becomes lost within the process. Rather **we are to consecrate/אצא every process and form of these ten states** unto the revelation and extension of a Name. The invisible Name and the visible state remain distinguished. Each of **the ten states are the means to extend and draw us out of our veiled habitations into residences of light.** The concept of these nations/אצא are the means to communicate and hold together the messages conducted unto us. These ten processes have been recognized from the days of our coming into the earth, become apparent through our transformation mode. They assist us through our journey and provide a place to reside as we verify and surrender all to Wisdom.

## *The Land of the Qenizi Thought Process*

2. The Kenaz/Qenizi/Kenizzite/אצא/State of Chayit, corresponds to the right index finger, to point/detect direction of a thought process or to make the place. Each of the ten fingers corresponds to the ten lands which are formed and entered by extending the Life within us.

**The Qenizi States are processes of thought to make associations between parts and to establish bonds between parts whereby each part supplies the other. The strength of these bonds is the Land of the Qenizi.**



In the Qenizi land we set goals. Among the Qenizi are the Names of Caleb and OthniAL. Accounts of the Qenizi are woven into numerous places of inheritance whereby there is a bond to that place. The Qenizi process is active within the ones of Avrehhem/ Abraham as they see a city afar off and then route their progressions to enter therein. i.e. Caleb is one of the spies that detects the inheritance of the land. The lands are obtained by full giving of our SeedName. One gives a good report through observations of the lands verses focusing on giants that live there. The Qenizi serve us as a dog scout, leading us to investigate a matter, to search out, explore, and determine a path to follow, not only to determine the course but to maintain the course before our eyes. Correlating the Ten States to our ten fingers, the Qenizi is the right hand index finger, *to provide direction*.

From the root, Qenaz/Kenaz, meaning to be an archer, spear thrower, lancer, the Qenizi are therefore known as spear throwers or archers. We cast our words as spears in a specific direction. As our words land in that space, we occupy them by our spirit. From our centralized strength we spread out. The spears are created by speaking with understanding depicting a silver tongue. We *speak with precise aim of placing the silver/understanding in the part or place targeted*. Via the spear toss one extends the understanding and engages the energies according to the understanding. In relation to masters of the spear, we target the use of words and our means to capture the essence of any word. Thus OthniAL captures the thoughts of the Túwrahh, coded as Kiriath Sepher, whereby one is given the Davir/The Word [Yahushúo/Joshua 15:15-16].

The Qenizi are often translated as *the sides/flanks/loins* denoting an ability to expand, contract, flex, twist, move, and carry forth the light perceptions of the Qayni. From the loins we *harness and release energies* to move with strength according to observations attained. When our eyes/rings are opened, it is for our movement and progressions. We follow through on the things shown to us by the Qenizi. Caleb testifies of this strength whereby one maintains a good report—stating that lands are of the Collective whereby one resist the temptations of the harlot or pseudo unions. Strength comes by being engaged in the Túwrahh [Yahushúo/Joshua 1:7] as one increases in the vast range of the Qayni attainments. Movements become more swift and precise in accordance with the understanding perceived. From the Qenizi comes the phrase, “*gird up your loins with truth.*”

The families of the Qenizi are birthed via Oshauw/Esau. From this heritage there arises in the land the Chief/ALphæh Force of Edom [ALphæh Dibre Hayamim/I Chronicles 1:36,53]. The chief of Qenizi **discerns suitable forms according to their underlying Principles, whereby one is not caught-up with materialization that does not serve the goals of their spirit**. One has strength to conquer Hebron whereby the associations are governed by the Thoughts of the Qenizi who are amongst our chavarim—comrades in the journey. The Qenizi make covenants with associated minds, creating bonds with YishARAL, whereby the body supports the Light within in. The Qenizi are **given territory in the lands of Yahúdah** and in the city of Yahúdah devoted to the priest of Aharúwan [Yahushúo/Joshua 21:11]. This **priestly center leads to all associations of thoughts**. The center of Hebron is a center in the kidneys. As all parts in the body correspond to centers in the brain both parts are connected in the mind and in the body so that the body and the functions of spirit are harmonic. In Hebron values of associations are discerned. i.e. Letters are

associated with Numbers. Inward parts are also connected with numerical values whereby they are positioned in the body to make their daily ascensions with the offerings of ALhhim.

The Qenizi regulate the offspring of Onaq/Anak/אֲנָקִים — those who choke or close off the neck from fantasies, fears, and illusions. They safeguard access to the neck and its openings initiated by the Qayni. Through the neck we behold and have access to the great associations of thought stored within our parts. Opening of the neck is the sacrifice of the keveshim within us. The opening of the neck creates a flow from every encampment within our houses. Those with insight read what is within the mind and body and appropriate the readings for ascensions. An offering or opening the neck without discernment is spilling the blood in vain. The later is what is called “sacrificing to demons/idols.” Though the neck is opened, what is within is poured out, through sex or by devoting the energies to a form or an illusion whereby they run without discernment or ascension.

**The Qenizi governs the six pairs—the associations of our inward members/tribes.** They uphold the parts as brothers of numbers/values. In this state we uncover, as one with a plough, the mysteries and concealments within the lands. The possession of the Qenizi include: the Sheishai/שֵׁשֶׁת/six pair administrations; the Achiram/אֲחִירָם/brotherhood of Numbers, and the Talmi/תַּלְמִי/those who discover via uncoverings [Yahushúo/Joshua 15:14]. Seated in these lands we are capture the meanings within words, and catch the collections of Numbers/Kiriat Sepher to possess the Devar/Word [Yahushúo/Joshua 15:15-16].

As a result of our pursuits into meanings and associations, in the Qenizi state we are in charge of the upper and lower springs of waters/מַעְיָנוֹת. A spring of water reveals and discloses what is present within our waters. The Gilat Olyot/the Upper Springs reveal the patterns in the waters above and the ascension of all that is within our waters. The Gilat Tachatyit/the Lower Springs reveal the underlying Principles that uphold all states of conductivity. The waters beneath verify that which is above as the waters within our bodies verify the Mind and Thoughts gathered above.

In relation to their mastery of associations, the Qenizi are saviours to YishARAL, for they lead the camps to evaluate/judge any things that hinders their progressions. In this state, we serve as the first or primary judge of YishARAL as OthniAL, who judges/שֹׁפֵט YishARAL in the sense to **put into place and establish the tribes via associations** with each other, thereby keeping them strong to prevail in thoughts and deeds. This judgment/discernment sets the tribes in their encampments around the Mishkan and joins their corners. The name of the Qenizi has also been used to express **the sides of the body**. We hold together the two sides of the loins/basins and the shoulders from which we hang the veils to compose the four sides of the Mishkan. Via our organization of sides, we serve in the Mishkan. We commit the sacrifice to the altar according to the pieces of the offering and place the pieces according to their residences/sides of thought.

As the Qayni, so are the Qenizi known as smiths and engravers. In this state we function in the House of Knowledge. The inscriptions pertain to thought associations of knowledge and their fortifications. From the Qenizi comes the father of craftsmen of the forest—to engrave with words of knowledge [ALphæh Dibre Hayamim/I Chronicles 4:13-14].

Blessed is YishARAL to enter into these lands/states, for in so doing the members of a Name function in all states of Light with the Fathers. As we discern that which lies within our members, we arise with the thoughts of the Fathers which emerge and break-through the configurations of mass/body weight. As these thought patterns arise and are exercised, we dwell in the lands of our inheritance—that which is pre-ordained of the Fathers, above the degradation and confusion of the flesh without distinction and above the stench and decaying nature of the world. We enter into the joys of tents which are indestructible wherein is the eternal Life of our Name, a gift of YæHúwaH.

Are these state thoughts of the mind? Yes; however, they are also of the body for they are the States of your Name in which your members dwell. Are these states like countries of the world? No. These lands are of your Seed, which come out of your Seed like evergreen that come out of a pine cone.

### *The Land of the Qedmuni Thought Process*

3. The **Qedmuni**/Kadmonite/קדמוני/State of the Tæyth/⊕. The right middle finger/fullest extension of the right hand, corresponds to the Qedmuni land in which we determine/affirm our origins and acquire illumination through the gates. This is the state to distinguish each category of thoughts.

Qedmuni States are in the east whereby we distinguish all things as they the Light illuminates them in our Eyes. The State is from the root word, qedem/קדם, **meaning origins and places of emanation**. We determine the origin of a matter and the processes of thoughts whereby we categorize every word, thought, and their forms. We enter into this land as a School of Thought when we come into the Wilderness of Qadamoth. Here we learn the origins of Light and the formation of words [Mishneh Túwrahh/Deuteronomy 2:26].

The **origins of Light** are in our spirited Name and come from the Words of our Names. Within Breath is Light. As we speak, we form crystal patterns. The patterns appear through our thought waves of Fire. As we speak/project these patterns of thought we form the moon—the understanding that encircles us; the stars—the clusters of knowledge that gather in our space; and planets of light—associated bodies of thought via which we make progressions and maintain balance. All Lights follow in accordance with the patterns of Breath, where the Spirits of ALhhim appoint them, whereby they are suspended by Spirit.

States of peace result as we speak from our Name verses of speaking the chatter in the world. In Qedmuni we learn how to behold a structures of concepts [Sichon/Sihon] and how to compute and reckon/number all things [Heshbon] whereby we behold states formed by words of wholeness. The Qedmuni process is occupied by the House of RAúwaben to be used by the eyes. Hence, when we see through our 7 Eyes, we observe all things from the Qedmuni Lands. Every level of sight composes eight levels of perfect sight according to the offspring of RAúwaben. [For further information, consult BHM: CHP 26: The House of RAúwaben.] Hence, as RAúwaben dwells in the south east

corner of the camps, the eyes are gifted with illumination coming from the origins of Light. In the State of the Qedmuni one distinguishes and reveals the full spectrum of the Word.

Via the knowledge attained in *Qedmuni*, the gates of a Name are regulated. Thoughts emerge and become intertwined at the gates whereby we connect thoughts of Knowledge continually passing through the four gates of Zebúwlan, Beniyman, Gad and Nephethli. Likewise, we receive Thoughts of Wisdom and Understanding associated with the respective gates. Through the gates we receive and transmit messages and accomplish transactions. In the gates we take care of matters and achieve resolutions. Thus, in the black text the gates are referred to ones enemies, seats of conflicts for in them we make resolutions and peace. The reference to enemies pertain to ideas in opposition or secondary issues to the inner order preference. The gates are also referred to as the gates to our cities—to our inner assembled camps. The gates are like revolving doors through which we encounter all levels of information that passes to and from our inner cities of occupation. At the openings we manage our Principles and process information. Here we make decisions of priority. Some ideas get xed-out and other become solidified. In that the elders converge at the gates, we bring to the fore the most aged amongst us to sort out our words and discernments at the mouth/eastern gate and to distinguish our seeds/harvest in the loin/western gate. At the left arm/north wing opening we discuss the mysteries, and in the right arm pit/south we have sessions of Council and orders of proceedings. [References to the gates include passages in the Túwrahh and Tehillim/Psalms: i.e. Sepher Maoshah BeRashshith/Gen 22:17, 34:25; Tehillah/Ps 127:5.]

The regulation of information comes through the four openings of the gates during each month/moon cycle. The tribes are regulated via the gates of the throat/east, the gates of the left/north side, right/south side, and the gates of the loins/western quadrant. From these four mouths the Letters come forth from HaSham. In the likeness of ALhhim, the gates of our temple are dedicated to transfer the messages of Light. The opening of the Gates is by Breath. Through the Dallath in Qedmuni the light rotates into our members, as the moon passes through our camps each month.

Through each gate the Letters come forth in sets which form each of our parts. In each set are the three rows of Letters. Each row contains seven Letters all joined by the Letter Taúwah, which appears in the fourth mouth. During each month the sayings of the Lights pour forth through our gates. During the days of a month, the messages are computed according to the arrangement of the Numbers and Letters of a House. During the month, days 1-7/ALphæh to Zayin, messages come from the mouth flowing from full moon/left north side gate; days 8-14/Chayit to Neúwn utterances come from the east gate (quarter moon/throat side gate); days 15-21/Semek to Shayin words come from the mouth of Wisdom (dark moon/southern right arm gate); and days 22-29/Taúwah, a gathering of consciousness unto the full moon, occurs from the mouth of Totality of all sayings into One (half moon unto full moon/western loin gate). During each day sayings are uttered through the teraysarun window of the month which is poised in front of the sun. The words of knowledge proceed by night as instruction [Tehillah/Psalm 19:2-3]. ***The voices from the heavens are heard without limit—far extending!*** מְלִצְפָּן וּמִבְּרֵית הַשָּׁמַיִם. Most translations state, neither is their voice heard; yet the Hebrew reads: “***Without limit, there voices are heard,***” even though there are not audible sayings or words. We read/comprehend/hear

the messages in our gates. The elders of a House in their month gather in the gates of a House to confer together regarding all information processed through these portals. As a serpent opens an egg with its mouth, all of the gates are opened by the tongue. Asking a question leads one to great explorations and findings. Thanks be to HhaALhhim!

The Name of Qedmuni is made up of five Letters. The signs convey the sanctification/regulation/⚡ of the gates with insights/Δ of conductive communications/⚡ unto complete/∞ achievements/↯. The Letter Neúwn/fish and the Letter Yeúwd/hands at the end of the Name Letter sequence conveys a regulation of thought unto complete activation and fulfillment. Via the Qedmuni our eyes see in stages of thought progressions unto beholding the complete strands of truth pertaining to all in the Mind of YæHúwaH from the beginnings.

From the root word, *qedam*, meaning east, *the Qedmuni state contains emanations of our origin unto our full brilliance*. As we make the place for the emanations of our Name's origin, from the Qayni and Qenizi, we enter into them. As a tree, space is first made whereby the traits in the seed appear. Through the gates of the twelve tribal/branching chambers, the lights of words pass. What is opened via the Qayni, and paired via the Qenizi, passes through the gates to be fully known and elevated in the Qedmuni. One may see the correlation in the daily occurrence of sun rising. First, there is the shimmering rays of light that pierce the eastern sky—the Qayni. Then the rays are cast forth like spears, targeting the rays unto full occupation and impact—the Qenizi. Then the light passes through the hours of the morning unto full ascent at noon—the Qedmuni. In the course of day, the illumination arises until there are no shadows of observation. This position is the full extension of the middle finger of the right hand—the Finger of the Qedmuni, which is also the finger of the House of RAúwaben to whom the Qedmuni are given [Yahushúo/Joshua 13:18].

**The process of illumination occurs through studying and meditating upon the Law written in the signs of Light. As one studies the Túwrahh for the sake of the Collective, the light breaks open within the words—the Qayni. The rays of light pierce the heart with illumination—the Qenizi. The illumination regulates the houses through the gates the Qedmuni. What is acquired through the Qayni is released into motion via the Qenizi and then extended unto its full ascent in the Qedmuni.**

Open your right hand and look at the pattern of the lines and the extensions. The thumb, pointing eastwardly is the Qayni, an instrument to open, grasp and hold. The index finger, being the Qenizi, is the instrument to point. The middle finger is the Qedmuni, the full arising of the light as the sun arises from the east. The right hand, from the thumb to the little finger, is formed according to the motion of the sun as it arises and then falls/sets. Your hands are handling the Word of Life. All that is within you is the structure of the Word [I Yahuchannan/John 1:1]. The Qedmuni bring up the insight to its full ascent. What is acquired and has been associated with a thought or form is drawn out until we see the radiance rising in majesty like a king/queen standing from their throne. The Qedmuni elevate the light within us to remove the shadows of the initiation/early morning. The details in the darkness are discerned, and the tribes/12 members are regulated by the daily sacrifice of ascension.

The Qedmuni serve the Laúwi of Marri/Merari. RAúwaben provides residences for Marri to reside in the villages of the Qedmuni. The backbone of the House is brought into the House of RAúwaben—amongst the rings causing the tent to rise. All that solidifies in the north, from the observances in the south, are united together as one body [Yahushúo/Joshua 21:37; ALphæh Dibre Hayamim/I Chronicles 6:77-79 English Bible text division or 6:63-64 Hebrew Scriptures text division].

The Qedmuni are among the Chiefs/Aylúwf of YishmægoAL/Ishmael, which rise from the loins of Avrehhem. In the State of Qedmuni a Name interprets clearly all visible rays of light [Sepher Maoshah BeRashshith/Gen 25:12]. Via YishmægoAL, a bridge is formed from the realms of Light unto the earth to disclose the structures of thoughts in the Light. The ability to interpret everything seen is given to the House of RAúwaben as they provide for the Qedmuni.

Keep in mind during this study that the ten states/nations/processes of our inheritance pertain to our use of words and their thought processes. In these frequencies of Light we have been begotten, and in these frequencies we dwell with full comprehension. In Light of Túwrah parables, YishARAL is born in the lands of Cham, for so they have been from the beginning whereby these lands are the lands of their Fathers. The lands of Cham/𐤇𐤍 are from the heated waters of the Fires of ALhchim! In these ten states one has a dwelling for their spirit. In our states of residences we fulfill the image of ALhchim. As all in the heavens and earth are based on words, in these words we live, reside and have Being.

The first three nations: the Qayni, the Qenizi, and the Qedmuni, begin with the Letter Qúphah/𐤒. This letter conveys the dynamic spirals of the Breath to create a spiraling cloud of smoke. As these three Names pertain to the rising sun, the Qúphah illustrates the dominion of Light that arises out of the north, appears in the east, and sits upon its throne in the south. As smoke arises from fire, the Qúphah/𐤒 arises from the Lights of the Hhúwa/𐤇 and the Fires burning upon your heart altar. Via clouds of smoke we create States of the Qayni, the Qenizi, and the Qedmuni. These three States of Thought are foundational to our habitations of inheritance and are made through the ascensions of our Light. The three States correspond to the Zayin/I, Chayit/𐤇, and Tæyth/𐤇 that form the foundation of the Flying Serif.

### Be Fruitful and Multiply

You can open a thought and eat the fruit therein. There is a thought that we ate from the Tree of Knowledge. Is this thought of Wisdom, Understanding or Knowledge? We consider that this idea is of Knowledge for eating fruit is of the branches which rise from the trunk of Understanding. What is the origin of the thought—which land is it taught? The Qedmuni/Kadmoni? The idea comes from a quest to be fruitful and multiply which pertains to using Knowledge. Upon branches of Knowledge fruit appears via which seeds of a plant multiply. **To be fruitful and multiply is by generating the Faces of YæHúwaH and increasing in Seed Principles.** When you generate the Faces you automatically magnify, increase, the Principle.

The Tree of Knowledge of good and evil is teaching to discover life/ascension and death/extension. Those who eat of it are willing to accept the consequences to become fruitful and to multiply. The fruit of our Name is born on the boughs of the Tree of Knowledge—upon

the tribal branches that extend from the circles of Understanding, even as the branches of a tree come out of the inner circles of the trunk. Did you ever see a knot in a tree from where the branch came from the side of the trunk body? A knot is comprised of patterns of circles like the joints in your bones to which your extensions are joined, just as a branch is joined to a trunk. We approach the Tree of Knowledge by first considering the Foundation of Wisdom and the Circles of Understanding supporting the branches. We may reach our hands for the fruit on the Tree of Knowledge when we are in a State of Ascension. Only then can we take hold of the expressions of Knowledge for they appear in the outer extensions/branches of thought. Via the Qayni process we are readied to grasp the fruit/expression. What is in the fruit? There is a pulp—literally a weaving of thought strands of light. Each fruit type is according to the seed patterns within the fruit body. The fruit on the Tree of Knowledge contains multiple seeds, scattered within the flesh. The patterns of the seeds are multiple thoughts, as clusters of stars flung into a space. What does the fruit on the Tree of Knowledge of good and evil taste like? It is slightly salty and also sweet, somewhat like salt water taffy. The salt depicts the original core values which are never lost. As salt rises from the ocean floor, the preservation of Wisdom rises into the fruit of Knowledge. The sweetness denotes that it belongs to a covenant—a state of agreement. Most fruit have sugar content, whereby the food is palatable. Sweetness conveys a bond or state of agreement.

The outer shell of the fruit holds the covenant pattern of the original inner agreement. The covenant made by maShayh/Moses with YishARAL is a second covenant which affirms the inner nature of life. The outer covenant pertains to branches that arise from the foundation of Wisdom. Being of the outer realm it could be broken without affecting the first covenant—the inner pattern; however, when broken it would be severed from the inner covenant for it became apart from the life of the Vine. In this manner the body becomes separate from the spirit until the form of a Name receives again the renewed covenant within its members. The breaking of the fruit of the covenant is as one taking away fruit—the expressions and teachings from the Tree of Lives. Within the fruit are the core elements/seed constructs which stand the test of time. The fruit of humanity in Babel fades after harvested for it does not contain the pure seeds of Knowledge. Once the fruit is taken from the branches of Knowledge and separated from being rooted in Wisdom, it does not endure. As sin it is for a season without profit and cut short as the days of a man. The body of man is the fruit in which is the seed. The body is an expression, but not the seed itself. That is why fruit perishes in that it is a medium to transfer a Principle and used to express the Principle of the season. As the frequency of the Principle changes so does the fruit. Therefore, for the fruit of our Name to remain, as an immortal body, the frequency of the Principles in our Name are transformed according to the Faces of the Fathers.

Fruit we bear on our Trees of Knowledge endure as our Names. The fruit of our immortal house contains eternal life and exceeds the nature of mortal dispositions. Moreover, we are not to mix—plant or weave—different kinds of sayings and concepts, for they do not remain; hence, it is a vanity and wasting of Breath. What we thought when we were children does not mix well with what we are thinking as we age. We do not mix prior religious thoughts with the frequency of thoughts emerging in your SEED for they are not compatible to dwell together.

Fruit is a product of the tree and abides unto itself once it is picked. Hence, what is mortal, or taken away from the Tree of our Name, perishes in that it is not connected to the foundational source of Wisdom. When anything abides by itself it spoils. This is a main reason for congregating and having assemblies so that no one dwells alone. No one lives unto themselves once they comprehend the United Branches upon the Foundations of the Twelve in Wisdom. Once we are born from our mother, it is said that our bodies begin to die, for they become separated from the Mother. Because we are born of the flesh, we enter into a split-body; anything that splits off from another cannot sustain itself—that is why the flesh dies. The Prophet Yeshoyahu [Is 14:31] states that no one will dwell alone in the appointed gathering. All peoples and nations are united as One. One who accepts flesh as a form of fruit *apart from* the Tree of Knowing good and evil/associations accepts thoughts not in accord to the Tree of Lives and thereby it falls. ChaúWah/Eve does not remove fruit from the Tree of Knowledge, but rather depicts one who by perception—by the eyes—takes fruit not in accordance with the Tree of Knowledge—the minds of Hhakuwáhnim/the priests. The woman in the text conveys the body that accepts something by the external eyes apart from the Eyes of its Name. As the flesh struts itself in exaltation above the inner Breath and projects itself outwardly it remains apart from the spirit of life. Therefore, we keep the flesh abased so that the Rúæch is exalted in our veils. In so doing we demonstrate that we have come to know the Life to whom we belong and that we have set aside the flesh and all that divides and separates the Breaths of Names.

Mortal flesh is a wrap of a split body. Like the flesh or pulp of a tree, the mortal body perishes. As we move into the Lands of our Fathers to abide in a whole embodiment, we put on the Oyin-Zayin garments. In this body we are joined, Name to Name, as two Teraysarun as one, according to the compound Name of YæHúwaH.

The Qedmuni/Kadmoni State joins to our former dwellings and to the origins of all states and thoughts. Being of United Breaths, we are of One Body. This Body is the pattern of the House of YæHúwaH expressed as a Union of Two Teraysarunim—unified dodecahedrons. The Union of Two Teraysarunim is of the mastery level conveyed in the Name of Dæúwd/ΔΥΔ whose heart is set upon building the Bayit/HhaSham/Bet HaShem. Every word and Name is a of a Teraysarun of OLiYun/the Most High. Via uniting the Teraysarunim, the House of YæHúwaH is built with multifaceted diamonds. The term in Hebrew, *davar/word/* אדא conveys that each grouping of Letters is a Teraysarun/Δ of Whole/Unified/9 Thoughts/4 via which a House/9 is built. Together we comprise a whole body, founded upon the living Principals of Wisdom, within the seventy spirals of Understanding, ascending into twelve branches of Knowledge unto eternal Life. We are born into a house/cluster of Names wherein our Name is read/called in the House of YæHúwaH. The House of the Name is our foundation and core cell after which all cells in the body are formed to comprise our being. The states of eternal Life are according to the Name of YæHúwaH, which are of United Names: Yæhh and Wah. The Name of YæHúwaH, in the molecular construct, deduces to 11/Υ—the Tree of Lives. The Kephúw/Υ is the central Letter in the Garden—the Tree of Lives, which arises from the Dallath/Teraysarun base and reveals itself by the four sides of Light. According to the Garden of our Name, the thoughts of Light are arranged from our Name to hang on fruit on the Tree of Lives whereby it remains.

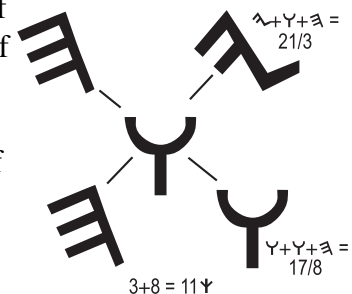



In the House of YæHúwaH we abide as joined Teraysaruns, diamond shape facets, each set being a unity of four united bases, four faces, eight inner gates and twelve exterior gates. Being of twelve branches of thought according to the pyramid constructs of Wisdom, Understanding, and Knowledge there are a combined value of twenty-four gates of Knowledge according to the mastery level of elders. These refined thoughts are the twenty-four elders, for the aged of our Names occupies the seats to direct and comprehend thought processes as well as to defend our habitations. As elders are at the gates so bees station themselves at the openings of a hive in which the queen of Wisdom abides. We are born within the House of YæHúwaH and thus offspring of YæHúwaH. Our Name is whole/perfect just as our Keeper and the Principal. Our split physical bodies are according to those who bore us into this darkness/layers of flesh—that distinguishes. Though we come into flesh from two, father and mother, we are a divided house, for the flesh contains within itself strange elements to abide alone and apart from the whole [Yeshoyahu/Isaiah 14:13-14]. Having once been occupied within the womb of Wah and sat upon the lap of YæHH, we have within ourselves the way to return unto the State of Breath which is above the natural world perishing.

### Liberating our Names unto Growth and Multiplication

How did we make the transition from a whole paired habitation unto a split-body? This involved many sequential patterns of thought. The account is told in the narrative of The adim and Chaúwah who dwelt in the Garden of Eden. The fruit from the Tree of Knowledge is an expression of Wisdom from which the branches of a tree arise. What took place in this account was a splitting of the fruit, half to Chaúwah and half to Adim. The restriction not to eat of the fruit is best understood that we are not to consume the fruit whereby we break it apart from the Tree of Knowledge. A correlation to this pertains to the fat of the Fire offerings that we are not to eat, but rather we are to appropriate the fat unto the Fire. Likewise, we are to maintain the expression/fruit of Wisdom's Unity verses consuming it and dividing it, from whence comes the basis to form a split-body. This primary thought within the Garden of Eden is at the Wisdom root level of consciousness. The thought is then carried forward in the account of Núwach wherein his son, Cham—that which pertains to the branching of thought to make visible—internalizes the nakedness of his father. The concept of becoming naked implies coming out from within the covering of unity which discloses their separateness. Thus, Adim know of nakedness, for when the fabric of Unity is torn, there is a tearing of the garment, and that which is inside becomes exposed. The second account in Núwach establishes the thought of division from the base of the garden into the vineyard, that is, within the Teraysarun of Understanding. The land of Canaan/Kenon, or that which will come forth from Cham, is therefore cursed, or better understood, becomes restricted from ever expanding to dominance above the Unity of Breath. This retention/curse has arisen within the trunk level of consciousness where the divided thought abides. The third level of the curse arises within the Land of Canaan when the House of Yaoquv strips Yúwspah of his garment and sells him unto the Yismaelites whereby he comes into Metsryim/Egypt/duality. This violation of Unity transpires within the Branches or the Teraysarun of Knowledge. Via this third affirmation of the curse, the divisive thought now enters into all levels of thought whereby the split-body appears or becomes manifested as a fruit

of transgression. The selling of Yúwsphah is the tearing apart of the thought garment whereby the flesh is torn into two parts or into a state of duality. The cry of the Mind is heard in the ears of all of the members of his household, for this is the Tribulation that comes upon the wounded Head of Yaoquv commonly referred to as Jacob's troubles.

Offspring of Names did not know how to fear the words of their Elders. Being immature, they considered their own way superior to the whole. The departure from the Breath Unions leads us to seek for the covering of our Name which is restored as Breaths are United into One. For in the restoration of United Breaths, we create that which was severed whereby we became naked. As the Breaths are united, they spin a covering of Understanding that surrounds both Names into One House and every name is comprised of a whole thought as it was born in YæHúwaH whereby no name operates by its own or for its own sake, but for the whole.

We took of the expression of Wisdom—the fruit because we desire to learn and be wise as the ALhhim—the aged of the House of YæHúwaH. In our innocence, we wanted to grow, and we wanted to know. In consuming/eating of the fruit of separateness, we accept the challenge to know ourselves, to know the goodness of Wisdom, and to know the compatible states of Understanding, and the full blessing of Knowledge. But in accepting this fruit, you will also know every thought that is antithetical to the Union of Lights, for you will not only know the thoughts that belong together but those that do not belong together, and in this discovery, you will love your enemies because they will reveal to you every expression that you are to overcome. But in our innocence, did we ponder, prior to taking the fruit, that there was another way to be fruitful/express with bounty and to multiply/expand the Faces of YæHúwaH within us, whereby we would appear as the Elders that nurtured us? Hence, in all of our proceedings of thought/sacrifices/drawing out our branches of thought, we make *our offerings of Fire unto the Faces of YæHúwaH*.

Do you see why it is called the Tree of Knowledge? **For the tree extends beyond the base of Wisdom and passes through, going beyond the House of Understanding.** Herein lies a great mystery. Our Name is a Tree of Lives. Adim and Chaúwah are paired Names in one thought; they are not split persons nor residing in fleshly bodies [refer to page 2 of Dan and also Adam in the BHM Túwrahh Dictionary]. When fruit is taken apart from the Tree of Knowing good and evil, it is the pulp/flesh of the fruit that is accepted which becomes the flesh of our bodies. In that we accept flesh, there comes a division in the Teraysaruns or within the Unity of Names. As a result, the unified body of Adim became two split bodies, and thereby comes death. Why is there a split-body upon accepting flesh? **Because the flesh divides, but the Breath Unites.** Therefore, we are called to return to our Breath Unions, to arise above the habitations of flesh, and thereby become fruitful and multiply the Nature of our Breath without the limitations of self-imposed mortality. In returning to our Breath Unions, we build the House of YæHúwaH, a House not made with hands nor the mortar of humanity, but a House of Breath in which the fullness of YæHúwaH abides with every Name making up the entire building of Light.

In that we come into the flesh, all associated thoughts of our Names come with us as disciples that follow after our Light. We bring from the Garden every teaching and every expression which are displayed in the vegetation and animal categories in the world. Thereby, all thoughts of

Knowledge that pertain to our Names are held captive within worlds. As we affirm the Union of Breath we set free every thought from which it resides and the entire creation shall be liberated unto which it groans for freedom, even as we ourselves groan.

In that we consider a means to full knowledge, how could it lead us to a demise? The lack of consideration or comprehension of all would transpire became what is called a deception that we formulated with our serpent tongue. Via this disguise/deception, we put on flesh, a garment of shame, that would cover us for a season. In that we ate the broken fruit, it became for us a covering through which we could abide to seek for the House of YæHúwaH and to expand the Name, but only to a level that the flesh could express. For unless a curse was placed on Kenon, the branches of flesh would acquire dominance and continue to thrive. Hence we partook, accepting the challenge, yet limiting our growth and multiplication. We became locked into the birth/death cycle.

In accepting the flesh as our coverings, we found ourselves in a split-body that cannot sustain itself. The flesh profits nothing; and without the upholding Breath, the body drops off like leaves from a tree. We continue in our mortality as we continue to break down the expressions of the Tree of Knowledge of good and evil, to gaze upon nakedness, and to sell our sexuality into duality. As a result we continue to produce a fruit after its kind—the flesh. And with our names coming into duality, we brought with us every kind of message, the glories of ALhhim, the music of angels, and the complete expressions or faces into captivity. Thus, all around, the groans of creation are heard, until all thought sequences are liberated unto their full united expression. The hand of redemption of the House of Yaaqov is upon us whereby we shall see every tree, every plant, the fishes and inhabitants of the sea, and every beast of the field liberated from the mortality of their habitations. For every tree holds a message of knowledge; every plant holds the principles (seeds) and glory (flowers) of ALhhim; every fish in the sea comprises the choirs of song to fill the universe—in them are the schools of music which abide with the whales and porpoises, their choir masters; and every animal holds a face of YæHúwaH. These all are projections of our Names, and with the liberty of our Names, so will all of the world be liberated unto the expanding, multiple, expressions of Unity.

As all properties of Breath are drawn out in regards to partaking of the Tree of Knowledge—for their full extension into flesh; so likewise all properties of Knowledge, under the auspices of liberated Breath, are raised until they are of the frequencies of Wisdom from which they have branched. All Knowledge within us is being brought to an alignment with Wisdom and thus liberated from the stronghold of the flesh body. If indeed we will come up through Metsryim—the duality that enslaves us with limitations and vanity, we will enter into the Schools of Thought and Unions of Breath without hesitation, unto the liberation of all Names to multiply/expand the glory that we carry forth in our Names. Through stages of distillation of Breath, all the knowledge of our Names became bonded to the gravitational spirals of the earth. In reversing the trend unto the expansion of Breath, we shall pass through stages of liberation unto our full emergence into the House of YæHúwaH. We raise the frequency of the members that lie within these bodies until, like the milkweed plant, they are released like strands of silk from these pods that they may glisten in the Light of Freedom. With this understanding we do not rebel nor retard the call of maShayh and the words of Aharúwan to enter

into the Union of Breaths [ref Meribah, THE DICTIONARY OF THE TÚWRAHH, Sixth Edition, BHM publication, 2004, p.131]. Via affirming our Origin in YæHúwaH, we enter into and dwell in the Qedmuni Thought process. Thanks be to ALhhim.

Sin—diversions of being aligned to our origin of Faces—is referred to a falling short of the glory/weight/substance of ALhhim, a lack of bearing the fruit of your Name. The shortness is due to slumbering in a descended state, and is not a negation of the Light in your Name. A greater sin retards or hinders others. However; as we give freely what has been stored in us, we make ascensions to pass through layers of darkness/habitations and leave sins behind. Through blessing others we establish paths to bless/expand our Names as well. You are never apart from YæHúwaH nor the Forces of Chækúwmah/Wisdom and Bayinah/Understanding, for they are ever present to the weak and the strong, in that they abide in your inner counsel and might of Unity, having established a unified Rock for your foundation which hold together your Names of Yehu—the inherent Faces of your Breath. You enhance the Faces of Yehu within your members through Dan, as you align your breathing to lift up all of your parts to the Seven Hills of YæHúwaH.

Coming into mortality is “a path for redemption” as to restore the soul—affirming oneself unto your full Faces of Yehu. The process of being born is structured for your benefit. You descend, as a SeedSown, in order to ascend with your glories. Since all Names are of the same House, those who get caught in illusions are viewed with compassion by those who have risen in the House of the Fathers. Delegations come from the Union, entering into an outer darkness with all souls, to demonstrate to the Union how to work through illusions and to return as an ascendant, thereby verifying the Light in your Name. We are servants one to another as comrades caught in an illusion, as in a mirror, to behold our strengths of emergence. There are two levels of Metsryim/Egypt, one in this level or outer darkness and one in the realm of the Union of Lights, for all states of Light have definitions. The definitions in outer darkness contain strange elements whereby there is corruption, and hence misery. Those of the Union come into this realm to assist our Names, as messengers. Some, without a body, are called “evil spirits,” meaning that they have yet to accept the human body pattern of HhaSham/The Name to affirm their goodness. As one accepts a body they bear witness of accepting the Order of the Union, having humbled themselves to bear the Name of YæHúwaH, whereby they are affirmed to be united into the Teraysarun patterns with their paired Name. The coming of Yahushúo, as well as other Names, come into mortality, to become sin for us (accepting slumbering) in order to quicken us unto our ascensions.

A **splitting of the foundational structure** in which a Name abides occurs in the land of Kenoni/Canaan. Kenon/Canaan is a level in the land of the Garden of OoDann/Eden. **The tear in the Oyin Sheath** or covering of Names occurs in accounts of the nakedness of Adim and ChaúWah/Eve; the story of Núwach via Cham, and the story of Yúwsphah in Potiphar chambers. Each level comes from an initiation or an acceptance of estrangement by selling Yuwspah to abide without the unity of the House of Yaoquv. Each tear in the Oyin covering occurs in Kenon/Canaan and pertains to branches of the Tree of Knowledge. These appearances of nakedness are within tribal divisions in the land of Kenoni—the state of branching in which the unified thought of the twelve collective sides are divided into the lands.

In the story of Yúwsphah/Joseph, one's branches of Knowledge became divided and split within the House of the Patriarch Yaaqov. Dividing Yúwsphah from the House of Knowledge and selling your means of blessing, functions of sexualities, in Metsryim/duality becomes apparent in the formulation of split/gender bodies. A split in branches from your VineOrigin yields a dying mortal fruit as expressions are separated from the living Tree of Knowledge. Yúwsphah is taken out of the collective and placed in the land of Metsryim/duality [Sepher Maoshah BeRashshith/Gen 37:28]. As a result of placing the foundation of Yúwsphah into Metsryim, loosing your means of blessing, other camps in Kenon become in want and in famine. Following all of the branches of Knowledge are brought down into duality, for they had disrupted the organized collective thoughts of Knowledge and could not continue without the Branch of Yúwsphah. It is not that the Tree of Knowledge is cursed or that Kenon is cut-off, but that division within the SEEDName occurs as branches are separated from the Foundation of Wisdom. In dividing the branches begin to dry up and eventually are cut-off from the roots and Her faithful trunk—the Lauwim. From the state of duality—out of Metsryim/Egypt, we are called to rise and bring up the collective order of YishARAL unto *the Aurets—the State where concepts of Knowledge are not bound to corruption but are at liberty and engaged in progressive transformations without retardations*. We must extract, draw out every facet of Knowledge within forms of Metsryim, and convert the frequencies unto its base—Wisdom, whereby our branches of Seed are reunited to Understanding/Bayinah as in Star Fields.

We create a collective manifestation which is the Bet HaShem—House of the Name. Via every manifestation we make apparent the invisible. Manifestations of liberty have no death nor corruption. We live within the Kingdom of Names to make a manifestation of the House of YæHúwaH. Instead, we made a house for ourselves, for we did not have knowledge to connect our Names into One House. The path before us takes us to a Y in the road. We may continue to go to the left and remain in split-bodies, or we may take the road to the right and arise through the houses we have built unto the Union of Breath wherein we build the BayitHhaSham/Bet HaShem—a collective construct of Names to make apparent the full Faces of Yehu. The House of YæHúwaH is built by Unions of Breath and the Assemblage of Thoughts. Let us put in the tent pegs and begin to raise up the walls upon the foundation Stone of DauwD as One House.

The Qedmuni will point to the origins of every thought and nothing shall be hid from its ascendant position. Those of Qadmon see from the upmost advantage point. From the East—the qedem—the thoughts of consideration appear in the palaces of the East, and with them the Houses of the Patriarchs and Priests. The Prophets dwell in the South in the midst of the academies of Light. The Kings/rulers reside in the West amidst the fortress and citadel of Tiras. The judges occupy their thrones in the North. Thus, as you speak, discern the gate from which the thoughts flow that your words be according to the gate.

## *The Land of the Chitti Thought Process*

4. The **Chitti**/Hittite/State of Yeúwd/right fourth finger

**The Chitti express thoughts to gather, seal, make complete or to secure a Principle. Thus as Avrehhem enters into the Earth—the Residence of Name to construct a House**

**and to establish the Name of YæHúwaH, he provides 400 silver—a Totality of Understanding—for the Chitti thought which dwells in the Earth field, as all levels of manifestation are designated by Mind to the families of Cham from which are the Chitti.** The Chitti correspond to the right hand fourth finger, the finger of confirmation and acknowledgment. It is also known as the rake or gathering finger. Nothing is gathered until its value has been determined by the preceding thought sequences of the Kayin, Qenizi, and Qedmuni.

Chitti, comes from the root word meaning to gather, seal and to secure. The Chitti determine whether or not to confirm the use of our members in any particular fashion or purpose. As one makes the daily ascent with the sun (the State of Qedmuni), perspectives are acquired hourly via the ascent and descent. The ascent is via the first three hours; the descent via the last three hours. Hence, the families of RAúwaben, Shamoúnn, and Gad are lifted up each day, and the families of Aparryim, Maneshayh, and Beniyman are filled with the corresponding concepts that relate to each of the pairs of sticks. In the first hour of the evening, discernment for all subsequent states are released from Dan while we are making the *kevesh echad* (evening oylah offering). In the seventh hour of the morning, the values of the first hour are filtering into RAúwaben where they will come to lodge to formulate blessings, garments, and adornments for each of the values. Also, regarding the months, what appears during the seventh month has been already given in the first month. Hence in the month of Yahúdah, being the first month of the year/𐤅; the bullock/𐤅 are given which appear during Sukkoth. And from the completeness composed in the seventh month, the Shayh appears during Pesach in the first month.

As the sun reaches its crowning point each day so it begins to descend into the vessels prepared for it. At the crown of the morning, the first hour, that heads the trail of ascending light, enters into the fourth hour, until the third hour enters into the sixth hour. All of the hours follow one another in ascent and descent.

When all values have been drawn up from within Yahúdah, your Name is robed with the traits of a King, for such will Chækúwmah clothe you within Her chambers. She will create upon your Name garments spun finer than the lily of the field. Instead of referring to Wisdom as “Her”/𐤅𐤅𐤅, let move into the Amuwri thought level of speaking, and render “Her” as *The Assembler of Breaths/Lights, One who composes the Principles of Light and intertwines the Breaths of all Names* as the United Branches of YishARAL. Hence, when YæHúwaH counts the Sticks that make up the House, they are counted by two, not individually. HhaSham does not look unto incomplete thoughts but rather thoughts that are whole, those with full expression. In the same manner we are sent out by twos whereby the trait of the Chitti is present to affirm and secure the words as they are spoken within any given land or dwelling of Names. Chækúwmah assembles the thoughts into pairs even as the hours are placed in sets of pairs each day. Hour One is joined with hour seven as Dan is joined with RAúwaben; hour two with hour eight, the third hour with the ninth, the fourth with the tenth, the fifth with the eleventh, and the sixth hour with the twelfth. For as Chækúwmah and Bayinah govern the day and the night, so are all Names positioned within their Household to govern the earth. Via the Chitti thought we affirm every cell and designate every form for the sake of our Names. The Chitti thought has been retrieved from the Pharaohs who know not Yúwsphah and restored unto the Aharúwanic Mind with those in agreement with the Priesthood of Aharúwan.

As the hours of the days are paired with one another, so also are the months of the year. The first six months of the year transfer the Light unto the last six months of the year, in which the first six month's illumination are gathered into the later months that hold their light. Hence, what is spoken in the first month of the year may not become visible until the seventh month, etc.

The crown of the year is in the seventh month when the sun is at the apex, crowning at the crest of the 7th hour in the day whereby there is no shadow. This occurs on Zickron Trúaech, the first day of the seventh moon of Aparryim and bears testimony that the garments of Aparryim are without shadow, lacking distinction. As the seventh month is in the midst of the months of the year, and as the seventh hour is in the midst of the day, and as the seventh day sabbaths occur in the midst of the four faces/sides of the month—on the eighth, fifteenth, twenty-second and twenty-ninth of each month, so is perfection in our midst!

*The Chitti gather and secure* the thought being processed through the twelve windows of the day as the moon and sun arise and set within twelve hours. Each hour is a period of 30° or a section of a day which conveys a frequency/wave length of thought. Hence, from this we derive that each of our six paired branches hold a corresponding wave length of light or thought frequency. Due to the similar frequencies, thoughts may be transmitted from one end of the stick unto another whereby both sides are built up and/or healed/made whole. As each paired branch holds a given frequency, likewise does each paired Name hold corresponding waves of Light which may affect the whole. A pair of Names can set into motion a thought within the entire body of Names, even as a single thought can cause your entire body to be washed over with goose bumps. As we view the 30° movement of Light daily, monthly, and yearly, we derive a ratio of 1:24, whereby the Amuwri thought utters: “Every 24 days a progression of thought occurs within a year.” Daily, monthly, and yearly, our Names pass through the gates of Wisdom and are engaged in the messages coming through the gates whereby we encounter the Voices of the 24 Elders. Each day has its thought processes as does each month and year. Thus Wisdom speaks: Blessed is the Core Thought—Adim—which hears the Guidance extended, keeping watch concerning My Gates day by day; keeping posted at the sides of the portals [Mishle/Proverbs 8:34].

Names within us operate according to their levels of expansion and acquisition of Knowledge which are dependent upon the Principle Base of Wisdom and the Words assembled at the gates day by day. According to the transmission, our Names are tested to implement the thoughts via commitments. **With each transmission of Light and gathering of Light, the Chitti verify or annul the thoughts being processed daily, monthly, and yearly. Verification are demonstrated in deeds.**

In ancient times, a king would seal a matter with the imprint of a ring. Likewise, as one considers a matter, the Chitti State comes to the moment of verification or reconsideration. The mentioning of the Chitti ring finger is not to mean that rings are not to adorn the other fingers. There are rings for all the fingers, as the fingers correspond to the tribes there is a ring for every tribe. The fourth *finger is the extension of thought to verify by the words of Knowledge*. Thus,

the Chitti thoughts occupy our dwelling with strength, trust, and security. This trust comes via the previous three States: we learn to acquire and open concepts whereby we come to order/direct and to manage the members unto the free expression of the concepts. When we learn to free share with another Name, we enter into a State of Verification and Trust.

Via the Chitti we come to comprehend the Love of the Túwrahh whereby it is verified in word and in deed. As we add up the Letters ALphæh to Taúwah, according to the number sequence of Wisdom—by ones, we figure the number 253, which reduces to a 10, and then a 1. In this number we verify the positions of Wisdom, Understanding, and Knowledge.

## *The Land of the Perizi Thought Process*

### 5. The **Perizi**/Perizzite/פריזי/State of Kephúw/right little finger

From the root word/Perez/פריז meaning to govern and rule, the Perizi are amongst the Chiefs and Rulers, whereby Thought processes become seated within us and we speak with the authority of our inner collectiveness. **Therefore, according to the State of the Actual arrangement of Names, so is one's authority and level of Mastery.** The term, Perez, denotes, via its extension of thought, the ability to convince, to overstate, as a group or mob becomes an overstatement of a thought, even whereby we may exaggerate to form an illusion. Such uses of the process of thinking is kept in subjection to the Actual Self comprised of the arranged members of YishARAL. Thus the Perizi convey the use of will to accomplish the goals and progressions of YishARAL and without such, we reside under the rulership of the process and not above it. Due to YishARAL not managing the processes of thought, the nations/goyim become greater than they are subdue them.

The Perizi, from the root, perazah/פריז is translated as dwellers/occupiers of open plains and and unwalled cities. This meaning is an extension of the thought to govern, for governing leads to spreading out like a vine into open plains. As the Lights arise each day, they spread themselves out and overtake all of the territories under their domain.

The inner trust of the Chiti becomes the defense of the Perizi. There is no need for walled cities, for security is found within instead of without. Thus the position of the right hand little finger corresponds to the meanings of the Perizi. It is *the finger of defense*, the finger without an outer wall. According to the Perizi, we govern with the scepter. The little finger of the right hand, in which we hold the scepter, is the extension of the decisions. Our word is the authority, to carry out all that is within us. What we have given approval to and stamped with the ring of Gad, worn on the right little finger, becomes *the operations of our government*.

The Perizi are linked with the Kenoni [Sepher Maoshah BeRashshith/Gen 13:7, and 34:30] denoting as thoughts branch, so they overtake an area. As the sun rises, Chækúwmah overtakes the east



and the south; as Bayinah rises, Understanding overtakes the west and the north. As thoughts rise and branch forth, so they gain power and strength, until they are mightier than the lands in which they are sown. In this way, the branching of YishARAL in Metsryim, leads to the House of YishARAL becoming stronger than Metsryim whereby they become free. So again, who would want to destroy the means of our freedom by destroying the Perizi? We are not to destroy these nations, but to ride upon these processes whereby the Inner Construct of Names is always at liberty [Mishneh Túwrahh/Deut 28:1].

How do we proceed into using all of the ten thoughts of the Nations? The Túwrahh states that an angel/messenger will “drive out/W<sup>4</sup>,” meaning “**to possess and bring together all processes into one.**” [Sepher Yetsiat Metsryim/Ex 33:2] Via the instruction before our Faces—unto our expressions of Names, we will learn how to join our hands together as One Hand so that which we take hold of in the right hand is carried forth and not dropped by the left hand.

As we follow after inheritances of YishARAL, we read that the Perizi Thought is mastered by the Houses of Yúwsphah, Maneshayh and Aparryim and later regulated by Yahúdah, the pair of tribes from which comes the lines of kings/masters [Yahushúo/Joshua 17:15-18 and Shophetim/Judges 1:4].

We are continually cautioned not to mix the tribes of YishARAL with the nations/processes that we are given [Ezra 9:1,2]. For in so doing, we cause the process to swallow-up the Actual Self whereby **the Actual** is caught up in the illusion and the projection of thoughts that we have carry us and more so regulate us until we are servants to that which we have created. The nations are given to us to be our servants and all who are faithful in heart/being steadfast to affirm the inner nature of Name and not dependent upon anything of this world [NehemYah 9:8]

The Perizi provide for expansion opportunities. As one operates with their inner trust, the fear of expansion diminishes. One is not afraid to pursue knowledge no matter where it is located nor is one afraid of the forms that are exalted without any base of principles. The **Perizi State facilities expansion** and occupying transformation exercises yet to be fulfilled by the developing inner tribes. Your questions and answers will be the processes for your expansion as your appropriate your findings into your expressions and the building up of yourself in the Name of YæHúwaH.

## *The Land of the Rephaim Thought Process*

### 6. The **Rephaim**/מַלְאָכִים/State of Lammæd/ℓ/left thumb

**The Rephaim Thought process pertains to healing/maintaining wholeness.** Healing is the sense of wholeness/completeness. Completeness commences with a Principle or foundational concept that expands to reveal the complete expression of a Thought Name. Illness likewise commences with an idea that culminates in a malady. Hence, within the strand of thought, that we call health, there is also the process of “weakness” via which health is determined. In this case, we view weakness in its positive reference; for what is weak shows dependence upon

another. The interplay or dependent nature of every Name and every thing unto something else is a stimulus and a means to attain health. Thus the term, Rephaim, has been translated to mean weakness as well as health. Rephaim is most commonly translated as a cure or to provide a remedy. The full revelation or expression of a Principle pertains to the health of a Principle. The revelation, when it becomes a complete expression, as a fruit upon the Tree of Lives, is a sign of wellness, vitality, and healthiness.

The Name of YæHúwaH-Rapha/ 𐤓𐤕𐤓, comes from the root of Rephaim/ 𐤓𐤕𐤓, attesting to the ever Presence of Unity that heals/completes. Every thought/ 𐤓 that expresses/ 𐤓 Unity/ 𐤓 leads to wholeness. “All of the diseases/deficiencies, which verifies the *Extended Hand of Totality*, are placed/set in Metsryim. I will not put upon your collectiveness the diseases of Metsryim, for *Anoki/the Extended Hand of Oneness*, is YæHúwaH Rophechaw—your healer” [Sepher Yetsiat Metsryim/Ex 15:26]. Why are the diseases/deficiencies set in Metsryim? For in Metsryim there are boundaries that confine the Name unto illusions. As the Extended Hand will not suffer the waters to overtake the earth, so will the boundaries into which we enter not prevail in strength to keep us confined. By the nature of the flesh there is a deficiency unto Totality which always conveys its weakness. For if the nature of the flesh was strong, then the House of YishARAL would be trapped into mortality; but due to the Extended Hand toward YishARAL, the strength lies in the inner to overcome the outer. In that the flesh is divisive, attests to its weakness and that it is apart from the Extended Hand of the Ten States of the Oyin consciousness.

The Name of the Archangel, RaphaEL, the messenger of healing, pertains to the United Order of a Name and carries messages that pertain to our completeness—even the fulfillment of our Names of Light amongst the whole. ***Thus we maintain no barriers of any form amidst the Union and the Household of Names, for in so doing we show our independence, which is a weakness, and thus hold back the fulfillment of our Names in the Union.***

The position of the thumb on the left hand is the extension of thought of the Rephaim. Using the left thumb we create impulses to transmit thoughts for the purpose of healing. The left thumb and right thumb are used to press upon the pyramid base of the medulla for restoration and healing as the left hand transmits that which is being conducted by the right. You may extend the right hand to help another up, but the left is used to lift up the fallen. Thus *the term, Rephaim, is used to denote what is high and tall, for when one is well they stand up, but when a plant is ill, it wilts and lies down.* That which exalts itself in weakness and idleness are smitten with the Rephaim by the Kings with Kedorlaomer—the white writings— [Sepher Maoshah BeRashshith/Gen 14:5] who conquer with cures and solutions.

**The Rephaim is a state of evolution of thought to bring all to the crown from the base.** As the Serpent folds itself in half, one half upon the other half, the tail is placed into the mouth. The Rephaim position, being the Kaf of the Oyin Body, becomes that was in the center now is located at the base. The Rephaim are also known as the Anakim/ 𐤓𐤕𐤓𐤕—those which elongate the neck, as those which seek access into another dwelling or habitation. The Anakim are a former state of the Rephaim, and known as the Emin/peoples/levels of consciousness which rises/ 𐤓𐤕𐤓𐤕 and becomes pronounced/tall [Mishneh Túwrahh/Deut 2:11]. The Rephaim have inher-

ently a consciousness to stretch the neck, to elongate the path into the sanctuary as one passes through the cervical canal. The Rephaim thought process dwells within the lands of Moab/testicles via which one may transference residence. In the illusive state, the Rephaim pertain to fantasies that choke oneness as one considers the mortal realm the real. In the Actual, the Rephaim heighten the Tree of Lives within us and lead us to lift up the immortal nature of our Name. Thus one may use the Rephaim state to enter into any of the levels of progressions as one draws out of the lands of Moab/region of the testicles, the State of their progression according to the Mind of their habitation. Thus in the Rephaim we find the healing of Yúwsphah's garments and the healing of the heads into one house again.

As we consider the health of our members and our bodies in particular, we are looking at the arrangement of the thoughts that comprise each of our members. It is important that if you have a weakness in one part that you consider its place amongst the other parts and realize that **the collective strength of all of your parts is the source of your being and hence the source of your healing.** If we look at *our bodies* or dwelling states, we see that they are comprised of the extension of Mind, and hence they *are thought extensions*. Within our body are four heads with four bodies and four lives/ivers. The four bodies are (1) the gonad/testes, (2) the ears, (3) the adrenal and stimuli glands, and (4) the stomach. These four comprise the body for each side of thought. In these bodies are relative points to the head that is hanging out in them. The corona of Ephryaim hangs out from the neck of B'NiymaN (Benjamin) and the testes of Maneshayh (Manasseh/Manaseh); the kidneys/liver of Yahúdah is hanging out into the adrenals and stimuli glands; the lungs or Dan are hanging down in the stomach; and the eyes of RAúwaben are hanging in the ears. We heal the four bodies by stimulating the thoughts in the heads of each side, for each of the four bodies come out of the four heads. Thus for the body to be healed, being an extension of Mind, we must heal the Mind according to the vision of Yechezqel/Ezekiel, a vision coming out of the North/Dan. Yechezqel beholds those in the Likeness/*Damuth* of ALhhim, with four faces, verses those in form of Metsryim [Sepher Maoshah BeRashshith/Gen 1:26; Yechezqel/Ezekiel 1:4-14]. As we are aligned with the Union of Names unto the Likeness/*Damuth* of ALhhim, Metsryim becomes healed from their divided bodies, and the garment of Yúwsphah is restored into the hands of the Hebrews whereby Metsryim no longer regulates the body to be mortal. When Potipher's wife took Yúwsphah's garment, it symbolized that Metsryim would possess the garment of Aparityim and render it as a mortal, subjecting the House of Yúwsphah to be in the hands of Metsryim/Egypt.

In considering the wholeness of the Oyin Body, we look at the heads from which the segments are derived. In looking at the four heads we are examining the thoughts, the unity of the Mind, and how our thoughts are extending the Principal of Mind into a dwelling state. The Rephayim/מחשבות are the Thoughts/4 manifesting/7 the ALphæh Principal of Oneness/4. Thus for Aparityim, the head of the west, what type of body does it create? Its' house is a pouch of balls/circled organs, as ripened eggs, which are the means to formulate a house in which Aparityim may weave the garments of YishARAL. As a house is woven within an egg so are the garments of our habitations, at each frequency of Light, woven within the testes. What do the eggs convey? The balls/ovals relate to the Letter Tæyth/⊕, the means of progressions and movements via the gates. Aparityim does not take to confinements or limitations, thus the House of Aparityim is Maneshayh which extends from the western side. Being in the west, Aparityim assembles the thoughts at their frequency and prepares for transitions according to our compilations of Light.

The shape of the House of Aparryim is oval and round like the orbits in which bodies of light travel. Aparryim leads us into progression and new states within the four phases every month depicted by the four balls of the United Names which are emptied and filled as the four cups of the moon every day.

The kidneys and liver of Yahúdah create six centres in the body to administer and implement values. These are the pituitary, the thyroid, the thymus, the pancreas, the adrenals and the prostate, which have the characteristic of transformation stages from the egg to the pupa to the winged beings which are of the House of Yishshakkar in which we are transformed and move from state to state. In that the House is winged we discern that values have the ability to arise within any structure. The pituitary and the prostrate mirror each other within the House of Yishshakkar, the dwelling of Yahúdah.

The lungs, what type of body does it like to dwell in? The lungs dwell in the stomach which is the shape of a horn and a vial to hold wine. The house of judgment/House of Dan likes to sound forth the judgment via the horn of understanding otherwise, unless there is understanding the judgment is not carried out. Thus the House of Ayshshur is the dwelling of Dan. After a judgment is declared, what is next? The sentencing which is the statement of understanding that carries out the judgment. Without understanding, the judgment becomes argumentative, like, who are you to say so?

And the eyes, what is their body? The Ears, for they like to have rings to catch the understanding of what they are seeing. The rings of the ears are the means to expand all that is seen whereby it can be articulated into thoughts. The ears are antennas for the ear and also as basins to wash what was seen before it is spoken in the river of Gad that comes out of the ears.

Thus, for healing we must consider the Principal being housed which is the source of the dwelling and the river or flow that is coming out of the house. In examining our Minds, there are four inner heads of Oneness. The mortal body has within it the pattern of the Mind of YæHúwaH but not the four faces of totality, for the mortal house is separated unto itself and unable to be woven. How is it that the pattern contains the four faces but the dwelling is of two faces? For the Name is within the vessel seeking the path of Serpent. **In that we have inwardly the State of the Kingdom of YæHúwaH, we have yet to project or extend the Kingdom, for as we extend the Kingdom we will be according to the four face creatures which are called The Likeness of Four Living Ones/Damut Arba Chayot** [Yechezkel/Ezekiel 15-7]. These are four faces for they have inquired into the Mind of YæHúwaH and have extended the Mind of YæHúwaH. They glisten with the color of the brazen serpent for they have obtained the Knowledge of YæHúwaH, having four wings and feet that are agreeable (commonly rendered straight) which convey that their walk is not divisive in any manner, for the collective faces move in agreement as the likeness of Adim, the unified coal of Wisdom filled with the Breath of YæHúwaH. Those who are of the Likeness/Damut differ from those called the son/offspring which is a dwelling yet to be extended to express the *Damut/Likeness of YæHúwaH*. Those of the Likeness are actually two Names joined, for their arms and legs move together as One. The two wings of each one are joined together comprising four wings via which they move/make progression together [Yechezkel/Ezekiel 1:11, 23]. According to their deeds, they cover each other

with the threads of the Oyin Body, being twenty-four twisted pairs of thought comprised of the twelve houses composing each Name. The vision of the Living Ones—in the Likeness arising from the Fire—is carried by Yechezqel/Ezekiel to those which have hardened foreheads and rebellious faces, as those at the waters of Meribah. Those which do not submit their Names unto the Unity of YæHúwaH House carry within them the waters of Meribah, for such are the waters within the mortal bodies that submit not to the Unity of Names to build the House of YæHúwaH. The waters within mortality are in rebellion to the United Order of Names. At Meribah the House of YishARAL contends with maShayh, not willing to part from their divided houses of gender. Due to hardened foreheads, the Rock of our foundation is split, and the waters of rebellion yet flow until they are gathered into a habitation of Unity wherein they abide in One House of One Name [Yechezkel/Ezekiel 3:7-9]. The rivers of these waters become foul due to the carnal Mind of Pharaoh [Yechezkel/Ezekiel 32:2]. Thus those of mortality hiss, curse, and fume with the foul waters of division. It is the waters of the Nile that are turned to blood for seven days as in the days of menstruation when the mortal is borne. All of the plaques upon Metsryim pertain to the blows upon mortality until the Hebrew Name that came into her is sent forth to serve YæHúwaH of the ALhhim of the Hebrews [Sepher Yetsiat Metsryim/Ex 7:16].

We declare that we are Oovrim/Hebrews, no longer carrying the confinements of the Egyptian body nor occupying a space to build mortal houses, for have joined our wings and have merged our Names into a unified house comprised of four faces. In joining our wings/arms we attest to resolving our faces of rebellion/separateness. We shift from mortal perspectives and operate according to the arrangements of thoughts that pertain to the aspects of MIND which are immortal. The Rephayim thought is the process of healing the divided cloth or the ripped garment of Yúwsphah. As the double helix depicts the twisted strands of thought, so do United Names build the House of YæHúwaH as Names knitted together to comprise the garment/skins of the Haikal/Temple. The Union of Names is the State of Reality; the pseudo world is of the illusive and divisive nature of flesh which perishes.

### The Square in the Circle

When one head amongst us is wounded, the corresponding head may attend to remedy it. i.e. Should Aparryim be ill; the Head of Yahúdah may heal the wounded configuration, or if RAúwaben (Reuben) is ill, the Head of Dan may reverse its malady. All four heads come out of the Centre and unfold themselves into a body. The four heads are four ALphæh within the Oyin which comprise the letter Tæyth. The Tæyth, at another level, may be composed with four Rayish. Via the appearance of the four heads the square appears in the circle; for as you join the four heads, the square is evident with the Taúwah in it midst. Those seeking Totality of Taúwah engage the Rephaim for the healing of their wounded heads. Separateness is denied. In maintaining self identify and separate bodies, one voids entrance into the Mind of YæHúwaH. While all four heads are latent within each Name as Principles, mortal man demonstrates a two headed figure. Four heads arise as Names are joined which is the healing of the Names and the restoration of the Name of YæHúwaH within the Houses

*“And the earth opens its mouth and swallows them up and the sum of their houses and the sum of their tents [Teraysaruns] and the sum of all that rises which verifies their proceedings in the midst of all YishARAL.”*

Mishneh Túwrahh/Dueteronomy 11:6

of YishARAL. This union is the joining of two Teraysarun's which comprises the Likeness/Damuth in the Name of YæHúwaH.

The four heads bury their Seed into their bodies from which all Principles arise within Bayinah. Until the four heads emerge, the earth swallows you up alive. For until the grain becomes harvested, the seed remains sown into the field. All that is sown will come to its glory, and nothing that goes forth from the mouths of YæHúwaH will return empty handed, nor shall any word be made void. As our heads emerge from within the veils, we see the Way beyond these veils, but when our heads are yet covered, we are destined to remain within this covering of ashes that swallows us, our houses and our tents/Teraysaruns until we arise—bring to the top all that lies within the midst of YishARAL. That which rises within us is verified by our progressions of thoughts and deeds.

Out of the four heads comes then four levels of Seed. We refer to these as the **four frequencies or waves of Light: the wave of Fire/origin/Wisdom, the wave of Colors/ Knowledge, the wave of Residence/Understanding, and the wave of Collectiveness/Totality/Laúwi**. Via the wave of Fire, all things have energy via which they can transform themselves from one state unto another. Via the wave of Fire comes all progressions. Thus, the House of Aparryim carries the initial wave of Thought whereby we are able to transform ourselves. Though we are caught and become slaves, we have within us the Wisdom of Names to break the bonds and arise unto mastery as Kings. The wave of Colors is carried by the House of RAúwaben (Reuben) via which the full spectrum of Name is known. The wave of Residence is carried by the House of Yahúdah which provides values via which spaces are designated. The wave of Totality is carried through the House of Dan which sums up all things into One, to be according to the power of the Wind/Breath that gathers all things together. These four waves are seen in the lava that runs, in the ribbons in the skies, in the creeping things of the earth, and in the breezes of the wind.

The square is identified by four heads which rise out of a collective consciousness of Oyin. The four heads are always within a circle through which the circle maintains itself in an orbit of 360°. Via examining the four heads within yourself, you find your foundation of Being and come to consciousness of your position within the Universe. Upon your examination of all inner components, you find the Stability of your Base or the Square upon which you rise unto transformation and freedom. Ask yourself difficult questions. *e.g.*

What are the main, primary attributes within me whereby I abide within the Universe? Let the Voice of your inner collectiveness speak whereby you can see the structure of Mind. Sense the Mind within that determines your present level of awareness; since the Mind that has extended itself into all of your parts; since the Mind that forms various houses; and since the Mind that holds all things together as One. If you desire evidence of these heads, breathe upon a window on a cold day. Notice that within the Breath are all the heads. Behold the Fiery vapor; note the prism of light that forms, see the shapes of crystals, and affirm that all waves are in One Breath.

*One draws near to  
YahúWah to give all  
within them to form the  
Body of their Totality—  
and to enact good will  
(acceptance) to the  
Faces of YahúWah.*

TeúwratHhaKuwahnim/Leviticus 1:3

*One draws near to  
YahúWah in sacrifice  
to establish the Letters  
and Numbers—  
to enact good will  
(acceptance) to the  
Faces of YahúWah.*

TeúwratHhaKuwahnim/Leviticus 1:3

Via examining oneself, you find the base upon which you may ascend. Upon this base you give all as one gives all upon the altar of sacrifice. In humility you bow unto your collectiveness and give your Breath to fill the square with the full measure of your Breath. In so doing, you form the Primordial Cube filled with all the Letters and Values of Light. Having found your base, you align all things according to the Base. Your thoughts that are of the Foundation are sorted and organized; those thoughts contrary are annihilated so that they do not weaken your inner construct and your expansion as you arise in consciousness of all within your rooms. Upon the base, you build the walls of Understanding and come to crown your house with Knowledge. In devoting all of your Name unto the Collective Order of Light, you build the House of YæHúwaH. You affirm that you belong to a world above corruptions and divisions. In so doing, you prepare for your ascension beyond the olem/world that divides and perishes. You are healed and come unto the soundness of Mind in Mashiyach—your totality.

If the heads become ill, then another must attend unto them. Thus servants of the priest are sent to find the lost and to bind up the broken. This is the ministry of the priests to restore each head so that the entire congregation/Assembly of Names is well with rivers running through the Body to bring forth the glory of the lands. Though another heal you, you are to affirm your wellness to the faces of the priest—the expressions of enlightenment. Thus Yahushúo said, “Go show yourself to the priest,” whereby your wellness is evident. According to the enlightenment of the serving kohen/priest you are affirmed to be within the congregation of the upright. For when our heads are ill, they are cast down and not held *upright*, but when your heads are united, they are *lifted up* which is the state of *YishARAL*.

The Rephaim healers make great the nobility of the Perizi—the expanding government—the State of YishARAL. Anything is recoverable as the left follows through on the right—the initiation. What follows the first five thought processes of the Kayin—to grasp and hold, the Qenizi—to designate/point and give direction, the Qedmuni—to pertain to the origins, the Chitti—to affirm and secure, and the Perizi—to govern and spread out, results in healings/Rephaim. However, if you let go of something with the right hand, you can retrieve it with the left; however, to be empowered it is to be exercised by the right hand. What the Qayni takes hold of is restored by the Rephaim. Each of us have a core thought that emanates from the Name of YæHúwaH. The core thought of our Name is our place within the Universe. As we grasp the thought that we carry by Name, so we will lift it up from where it has fallen within us. Follow through procedures are necessary to maintain healing and to maintain the position of the thoughts established. The plan that is set before us is held high within our vision that we walk after it. A wavering mind is always tossed and thus unable to walk in the health within its core Name.

Whatever is learned, directed, managed, verified, and expands now becomes increased via the State of Rephaim. We grasp thoughts and then weave them into a government constitution—the processes of Qayni through Perizi. All processed becomes a resource to heal the infirmities or to cure and mend the lame.

And hence, the question is answered: how does healing come? **It is via the Rephaim—by operating according/upholding/raising to the height the right hand characteristics of Word**

**Consciousness.** Built within our own word based constitution is the source of healing and fully manifesting a principle. **Rephaim** are the foremost of five thoughts extending from West/North complex via which we implement characteristics of the five on the East/South complex. *The State or Head of Enlightenment unto wholeness/wellness is the Rephaim.* Being too anxious, often times, we seek for a remedy without illumination or having our principles of operation (the right hand) in place.

From our ordination (beginning), the Rephaim are present. As we release an idea and establish the framework for an idea's expression, the Rephaim make it whole/viable in a State of occupation. Every concept and word becomes whole or manifested in its entirety through the development of the Rephaim. Thus, as we emerge in Metsryim, we encounter Rephaim as we proceed from Alush (ChameshHhaPekudim/Numbers 33:13-14).

As the first five processes/nations express the position and movement of the sun, so the next five correspond to the position and movement of the moon. Hence, the next five are States of Implementation of the Right. As the moon, the left carries forth the light of the day into the night. What is yet to be seen and discovered is already embraced with the carrying forward of the daylight. The night conveys also the darkness or the layering of the hours of day through which the light becomes fully known and revealed. At night, the entire sky, as a mural, depicts the locations and messages of the light. The light activities of the day are discerned in the night. The moon is the vessel of illumination to strategically reveal the months activity of light according to the day. The location of the moon each night, amidst the tribal constellations, corresponds to the activities and locations of the tribes during the day.

The activities of day and night are the basis for what some call the two houses of YishARAL. There is One Kingdom and One House to which all camps belong. When the hours of the day are greater than the hours of the night, the Kingdom of Yahúdah rules; and when the hours of the night are greater than the hours of the day, the Kingdom of Aparryim rules. Thus in the spring and summer, the Kingdom of Yahúdah, that dominates the east and the south affects all aspects within our collective dwellings. In the fall and the winter, the Houses of Aparryim affect the activities within our dwellings. Thus the rings of the camps of Yahúdah are worn on the right index finger, and the rings of the camps of Aparryim are on the left hand. Both the right and left hand comprise the Yeúwd, which is the means of extending and managing the affairs of our Name's habitation.

With your right hand opened and your left hand placed over it, so that the corresponding fingers are laying upon their twin set, note the progression from the thumb unto the little finger in both hands. The moon and sun arise as from the thumb, crowning at the middle finger, and then descending. The sun sails across the southern sky; the moon sweeps across the northern sky. As the moon spans from one horizon unto another with the tribal camps it set up its throne within one of the camps each month. From the Assembly of the lunar Light, it marks the seat of its throne from which it rules 30 days, which depicts the Lammæd or scepter of light. According to the location of Bayinah's majestic location, the months activity of light are determined. What is in the midst, between the right and the left hands, becomes opened and visible through the movements and spectrums of the luminaries.



Gradually rotate your left hand to the left until the hands are fully opened. Inscribed upon your hands are messages unseen until the hands are opened. The opening and full disclosure process comprise the nature of the harmony of light and darkness in creating living thought forms. Each one of our tribal energy centers are opened the same way, i.e. the eyes, the ears, etc. until they are joined together in the center mid-line to be healed or to express a wholeness—the Rephaim. Hence, *the State of the Rephaim, is to take of the light and to make it wholly expressed or manifested; this is the State of Curing.*

Financial goals are often the motive for service/labor. But can any currency compare to the Nature of Light that is expended toward another? Services that we render according to our Name cannot be compensated by currencies of the world in that the value of the service is beyond the illusion of the currency. Our journey on this planet is misdirected if our focus is on material acquisitions. The purpose of our journey is to be healed, to be completely joined in all of our parts unto the manifestation of the Likeness/Damuth of the One of ALhhim—the Teraysarun of Totality. Set first the Kingdom of ALhhim and establish righteousness—realignment of all parts with the Nature of Light. According to the Principles set forth, the manifestations follow. If we are setting forth the principles of materialism, then materialism manifestation follows. According to our sowing, we reap. *He that sows to the flesh reaps of the flesh; the one who sows to the Breath reaps of the Breath.*

### The Oyin Circle Patterns in the Hands

With your hands before your eyes, both opened side by side, note the looping/coupling nature of the fingers through which they can be joined together as well as to be joined with another. The three loops or segments of each finger, making a set of five loops, are the means to join the fabric or curtains of the tabernacle together [Sepher Yetsiat Metsryim/Exodus 26:3]. This Union is portrayed as we join hands together. Via united hands, we activate our belonging to one House/Tabernacle/Encampment/ Dwelling of YæHúwaH! We join our hands or activities of light unto fulfilling the tasks set unto our faces. Those who have joined their hands with the midrash have set out to accomplish the work of the midrash together.

The three segments of each finger correspond to the Nature of Light in three levels of occupation and expression. These three levels are vividly portrayed in the three levels of the Letters. As the fingers are stacked with three parts, so they convey the three operational stages of each of the Ten States of Occupation. The Túwrahh conveys this multi-faceted scope with the word, et/Xʹ which precedes the Name of each occupation/state of residence.

Patterns within your hands contain the Letters written in your palms as one would write a message in sand. You may find an ALphæh Taúwah combination beneath your fingers and notice other letters in your palms. Among other lines in the hands, there are two mountains, four rivers, and Tree of Lives rising up in the palms (as mentioned above in the section of the Perizi).

Each level of our fingers conveys a stage of development. Each finger extension contains three measurements for each of Houses within the ten Names of the States of Word Affirmation.

What do we mean by the State of Word Affirmation/Verification? Every State verifies and affirms the Thought whereby it is established for the proliferation of the Thought. Every state of residence is a verification of a thought, from the nest of a bird to the palaces of those with Understanding. Every house that is constructed, as the hole of the cobra, or as den of the wasp, or as the body of humankind, makes a house with the Oyin. The type of material that is used to build the home relates to the level of consciousness that comprises the house of the one residing there. The fabric or material of the house is an affirmation of the level of thought that is being woven from the Seed. One will sense various thoughts that are residing within a dwelling as you enter it. Those of the Oyin Land will be robed with the fine wool of the Lamb which is the Temple of YæHúwaH [Chazon/Revelation 21:22]. This fine whitened wool is spun out of the Bayit whenever two Names come into agreement. Whatever level of Unity that the Names enter, there is a corresponding garment. The threads of the Oyin are woven around the parts unified until every aspect of their Names are clothed with the garments of Understanding. Siamese twins are joined in part whereby they bear the testimony of being joined in the areas in which they are connected. If our hearts are united, the threads are woven around the united hearts. As we give all to the Unity of YæHúwaH we are robed completely in the eternal garments of Light.

Everything has its own type of blood which is the means of interchange between parts. The blood in the fruit is the juice; the blood in the tree is the nectar; the blood carries the life force in all things and whereby all things are united. Every organ has a type of blood, as the wine of the heart, the olive oil of the testes, the saliva of the tongue, the tears of eyes, the golden wax of the ears, and the vapors in the nose. All of the blood types within the house of Yisrael are transparent and not like the blood of mortal body. When Yahushúo turned the water to wine he brought up the Mæyim/Water State of Amuwri unto the Oyin Consciousness. In so doing he used the Words of Oath to the seventh power whereby he raised the frequencies to be according Oyin Head whereby all States within us are submitted to the Yevusi Thought.

The mortal fabric is a testimony to the thought of division and self-projection, for whatever is not completely devoted to the Oyin Land [Yahushúo/Joshua 21:16] contains the burden of vanity, translated into the weight of mortal flesh that hides the inner instead of radiating the Great Lights that are within. The Oyin Body is a humble abode, of crystal formulations, that reveals all that is within the State of Unity and hides nothing [Daniel 2:22]. Therefore, those of the Oyin Mind keep no secrets for they have their confidence and peace in Knowledge. Whenever a fault is discerned it is confessed openly whereby they release it from them. There are no

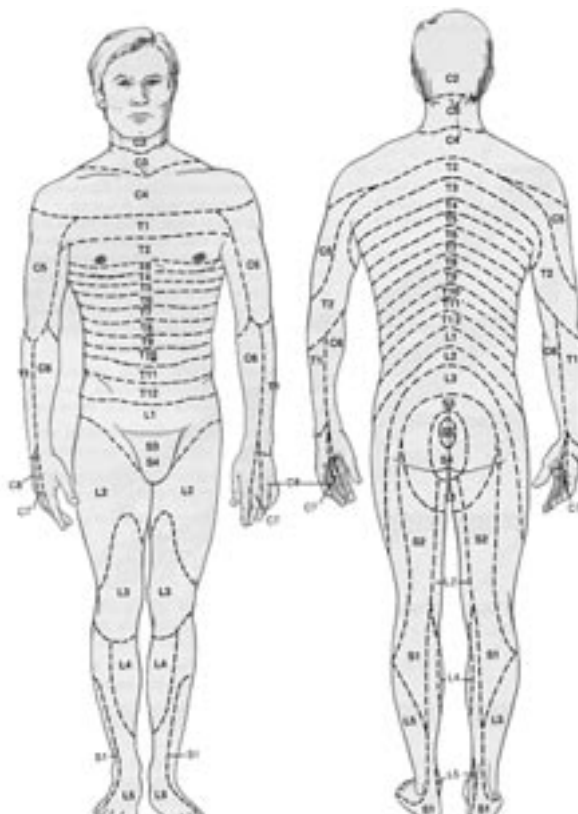

Illustration of the dermatomes and metameres/encircled segments depicting the Oyin consciousness comprising and surrounding all thoughts of Breath.

secrets to hide within them, for to have a secret is to keep separate and to hold on to a thought of division.

### The Oyin Circles Comprise all Habitations

Note the radiating Oyin/O pattern in your finger prints. As electronic discs and sensors, the fingers see and transmit via the Oyin patterns in them. The circular patterns in the fingers convey the radiating Nature of the Oyin to be extended into ten lands. The **extensions of the greater Oyin circles comprise the body**, known as the metameres and dermatomes (see illustration). Every Thought that pertains to our Name is surrounded with a pattern of the Oyin Threads. This pattern is carried forth in every state of residence. In that the mortal body contains a mixed formula, like the feet of the image of Nebuchadnezzar [Daniel 2:43], the mortal body will crumble when the Principle Stone strikes it. The final blow of the mortal statue is when the Breath rises in the Seed of Beniyman, whereby a stone is cut out of the Mountain. This Stone will cause mortality to fall to the Order of ALhchim YæHúwaH. The mortal body is the image of Nebuchadnezzar of Babylon, being a projection of outward exaltation. Those of the Hebraic Mind bow not to the outward which perishes but rather humble themselves to the Order of YæHúwaH within. The layers of circles pertain to where the thoughts of each camp gather to reside. Each camp has a set of circles, generated by the encircling thoughts of the Names within the camp. These circles of thought designate their Names to belong unto the Oyin State.

### *The Land of the Amuwri/Amori Thought Process*

7. The **Amuwri**/אמורי/Amorite/State of Mæyim/מַיִם/left index finger; *the Sayings of whole/complete thoughts arising from the Seeds of the Lamb/maShayh—the drawing out/Sayings of Moses, to be sworn/secure by an oath any thought of Light; to empower by speaking; to speak every thought to the seventh power.*

Within the successive *Visions of Avrehhem* [Sepher Maoshah BeRashshith/Gen 15:19-21], **the Amuwri**, meaning **The Sayings**, follow after the Rephaim, even as The Sayings convey, and therefore follow after the extent of our healings which maintain and expand the wholeness of Mind; for an incomplete thought, as a ill mind, cannot expand, being limited by its own division and estrangement to the whole.

In the Visions of Avrehhem, the Amuwri state is in the seventh position, for that which comes forth in every seventh level pertains to completeness. Thus **YæHúwaH swore to the seventh power every Thought whereby the Túwrahh is complete/perfect.**

The visions of the Ten Lands are seen and assembled in a progression of Ten Names. Upon establishing the processes of Ten Thoughts within the Ten Lands, the various processes of the Lands are used to achieve all Knowledge. The appearance of the Amuwri within a sequence/group of thoughts brings into play **the seventh power** which is required to develop and attain a concept or chain of thoughts unto completion. [See **Combined Thought Processes involving the Amuwri** in subsequent pages]. What is taught by the Priest, being the right index finger, is make complete by the for-

mulations of words of the Amuwri, being the left index finger. Every teaching is complete according to the Words or the Sayings that come forth from it.

Avrehhem's visions, as those of Yechezqel/Ezekiel, pertain to the Lands of YishARAL. Each State of the Land is a Vision, for each State is a Thought of Wisdom, formed within RAÚwaben, whereby a space is allocated for residence and expansion. The Land of the Amuwri is the seventh Vision in the series of the Ten Lands [Yechezqel/Ezekiel 40:2]. The term, visions/XYZ 4\*)/ *marot*, is the means that a Thought Concept/Seed is opened into the Mind. ***Thus via seed concepts, a Name comes unto the Land/Aurets of YishARAL.*** For which is greater? To be brought into the land of Metsryim by the seed of your father in the mortality of your mother, or to come into the Land of YishARAL via the Thought Seed of YæHúwaH. And which is greater? The Thought Seed within the Mind of the Priest or the seed within the womb? One land perishes; the other land is non-perishable. *As we maintain the Seed of our Name within mortal habitations, we remain in Metsryim. As we designate the Seed of our Names unto the Hands/activities of Aharúwan and maShayh, we are taken into the Lands of YishARAL.* As one sows, so also one reaps. The one who sows to the flesh reaps the flesh form; the one who sows to the Breath, reaps of the Breath life eternal. The one who sows to the flesh commits their Seed unto mortality and to build unto itself a house of Metsryim. Each mortal body construct is a brick for Pharaoh. The one who sows to the Breath/Reúwach/Spirit builds the House of YæHúwaH which is a construct of Thoughts that contain the Glory of the Name of YæHúwaH. For as YæHúwaH, says, My glory will I not give unto another except ***to YishARAL, which is the branching of the Oyin Mind/Yaaqov***/אֶפְרַיִם [Yeshoyahu/Isaiah 48:10-11; See BHM Túwrahh Dictionary entry of Yaaqov/Jacob]. YæHúwaH does not give the glory to another for if so doing, the glory would be limited and shadowed by the manifestation which projects itself above the Order of ALhhim. Thus when the Túwrahh speaks of the Mishkan being built and the glory filling the Tabernacle, it is referring to the Mishkan constructed by YishARAL—the United Names of Light within by the ten States of Word verification via which the Unions are empowered. Constructing the House via the stones of this world will be overthrown as they have been torn asunder each time that they have been laid, for they cannot contain nor express the glory of YæHúwaH. We build the House with our Names and Breath in accordance with the pattern of Thoughts in the Mind of YæHúwaH [Tehillah 127:1].

The brother of Yaaqov, Esau, exalts itself above the spiritual Mind, and thus precedes the birth of the Mind by bringing forth the outer nature first. That which projects itself above the collective Mind will be utterly consumed, for that which comes after, being the last, will become the first. The need of self projection will come to an end altogether. Even the means of self projection is subject to the Mind of Oyin whereby the Mind of Knowledge arises to topple over the body that wars against it. The fall of the natural body is depicted as Pharaoh is overcome in the waters of the Red Sea—the waters of Ayshshur/verifications of the inward.

Esau makes unions with the Chitti—the process whereby all properties of thought gather into Metsryim—for definitions and encapsulation. Via Esau, a Name comes into mortality to sojourn until they surrender to the Fiery Mind of Yaaqov [OvadYah/Obadiah 17-19]. Those of the South, having a Mind of Wisdom, will possess the mount of Esau, and those of the lowlands—of Humility will possess the Philistim, the state of trespassing, ***whereby an end of violations cease.*** Likewise, ***they—those of the South and the lowlands,*** for both traits are necessary—***will possess the***

**Land of Aparryim**—the means to branch and weave the House of YæHúwaH into renewing states. The field of Samaria, that is given to Aparryim and half of Maneshayh (which houses the Seed, i.e. the gonads) shall be restored unto Aparryim. The Land of Samaria (scrotum) is the space allocated to Thoughts of YishARAL, as land to store and safeguard the Seed for transitions and movements. As the Mind watches over its body, so does Aparryim watch over Maneshayh, to safeguard the treasures. The Land of Samaria shall be taken out of the hands of Esau and given into the hands of the enlightened. Moreover, the River of Ephryaim, which is the flow of Beniyman, will possess Gilead (the testes) whereby **the flow of concepts shall be in the hands of Yaaqov** and taken from the controlling thoughts of Esau to self project.

**We affirm wholeness of our Names unto YæHúwaH**, to be joined together and compose an expression of Unity whereby Amuwri Sayings come forth from our four mouths. **The Sayings are utterances of the unified state of being healed/made whole.** These Statements of Fire are amongst Branches of Knowledge, known as haDevarim/The Words. Being of the Mæyim/מ, they are uttered with a silver tongue, sharp as a diamond, to transmit Fire through distilled thoughts. As one speaks words at the Amuwri Consciousness, they can enter into any level of consciousness. For as Fire, so also Water, and Air, may enter into any State at any level of progression. According to the progression within the Oyin/O layers so are the Sayings.

The Amuwri communications, though spoken openly, are uttered in darkness, for only those who are of the Mind of Wisdom and the Heart of Understanding may hear and comprehend them [Sepher Maoshah BeRashshith/Gen 15:12-13]. They are not discerned, nor heard, by the ill or fragmented mind that wars against the House of YæHúwaH.

The Amuwri Land is for our occupation in Words and our possession with Sayings. With Words of the north/Bayinah, we declare the Path with the index finger of the left hand. **The Amuwri directs one to follow through in speaking all that was pointed out in writing** by the right hand. The GammAL/communication is written with the Yeúwd and becomes spoken by the Paúwah. According to the Thoughts of the priesthood finger of the right hand, which distinguishes concepts and Principles, **the Sayings of wholeness are uttered in the left or in the north via which they penetrate every level of consciousness, for the north wind can pierce even unto the bone/structure.** In that the Sayings are of the north/Bayinah, they touch the heart of every matter. In associating the pairs of fingers, 5 with 5: א + א, **we are extending the central control lands of the medulla in which are the two pyramids of the south and the north.** What is pointed out by the finger of the south/right is fulfilled by the finger of the north/left.

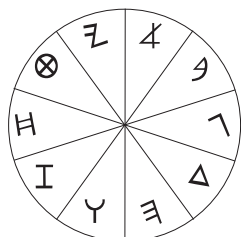

Each section of the Oyin Circle is 36° with a reductive value of 9.

Out of the Sayings of the Amuwri come meditations unto full comprehension. The one of the covenant draws out of the sayings the nature and authority of the concepts/4 which comprise the saying. The letter, Ha/א, preceding the State of Amuwri/אמורי אא indicates the illumination within the Sayings that are spoken from the north and not merely a repetition of the south. With the sayings, the mind becomes full with the concepts of light. The Amuwri provide a language to communicate a thought whereby it branches unto perfection. Thus the one who regulates their

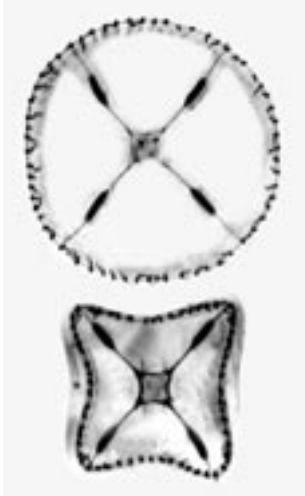

The illustration of the jellyfish depicts the square within the circle.

speech is perfect/complete/lacking nothing for all things appear via their Words whereby there is no lack of expression nor want of anything [Yaaqov/James 1:21-27; 3:2]. All religion and expressions of Faith, if they are not of perfect words, will lead to naught for the basis is incomplete, being not of an expression of the Words of Light and their unfoldments. If not of complete Words, then the forms of religion will perish as any other form.



Letter, Tæyth, value 9

### The Attainment of the Lands leads unto the Collective Consciousness

To attain the Lands, each process of thought becomes identified to pertain to the Nature of Oneness. In that there are ten/10 lands leads us to the reductive value of one/1 from which comes the sayings that “Ten are One.” Notice that what is expanded, as the ten, pertains to the south, and what is reduced, as the one, pertains to the north. In the south there is full extension and expansion, and in the north there is full contraction and reduction. Thus *when one speaks from the north, they speak with the voice of Bayinah, with full Understanding and Might. As the collective Voice arises from within us, being the sum of all of our parts, we speak with the Sayings of the Amuwri.*

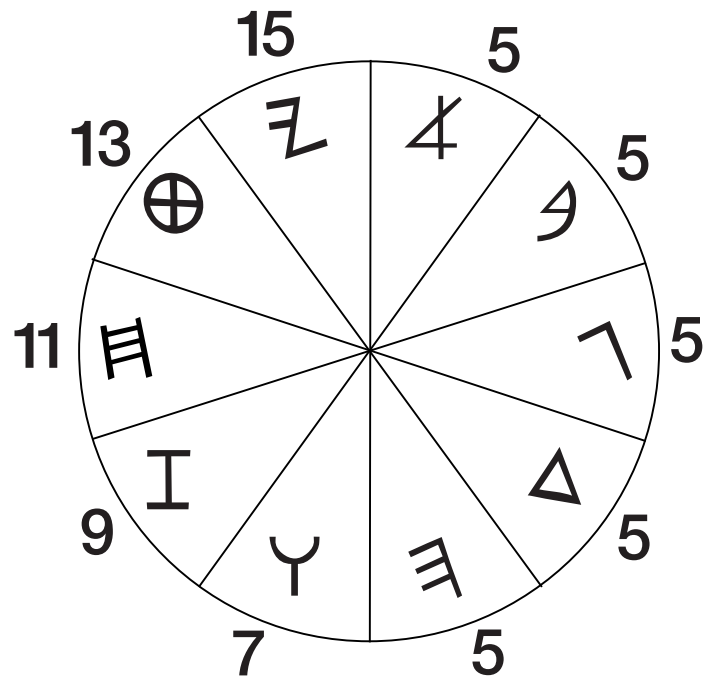

The attainment of the Lands comes from identifying *all spaces to belong to One—a collective of all thought extensions. Each space of the ten lands is identified by a Name which conveys the full residence of Oneness.* The space of each of the ten lands is formed by Fire, from which comes water and air and their assembly into land mass. The collective State of the Ten is within a circle; each part is 36° of the whole,

Uniting the fingers of the South/right and the North/left: 1 to 10 yields the value of 26/8; Aleph + Waw=7; Bayit + Zayin=9; Gimel + Chayit=11; Daleth + Tayit=13; Ha + Yud=15. The total sum of the ten numbers is 55, which in the north is reduced to 10/1. The sum of all values one to ten = one. In drawing out the values of the north to the south, Waw-Aleph =5; Zayin-Bayit=5; Chayit-Gimel=5; Tayit-Daleth=5; and Yud-Ha=5. The sum value of the lights on the South are 25. Adding the reductive value of the north/1, 25+1=26/8—the value of the Name of YahúWah/אָיָאָל—The Giver/Unifier of Lights.

which comprises 360° or the reductive value of Tæyth/9/⊕, which depicts the Collective Consciousness. Each of the segments of the Oyin Circle has the value of 36° or 9° which corresponds to the nine thread types of the Oyin Body, one garment for each of the states of consciousness. Hence we may state that each of the Lands is a State of Consciousness, a Nine/Tæyth/⊕. The reductive value of nine for each state multiplied by ten is the value of 90, the Tsade/𐤀. Via reading the numbers within the circle, we understand that **the attainment of the Consciousness of the Lands is the basis of Transformation and Liberty**—Tsade/90/𐤀. *The 10th power of 9/Consciousness (10 x 9 = 90) is the State of Liberty.* Thanks be to YæHúwaH who arranges our thoughts and places attainable values amongst us.

The measurement of 360° conveys the value of Tæyth/⊕/9 which conveys a collective state of Names and Thoughts. Within the circle of the Tæyth there appears four points/corners from which come the four quadrants and the square/cube. These four points are the cardinals of Wisdom: Blessing/Expansion according to Values and Discernment with Observation. These four are the corners of Aparryim, Yahudah, Dan and RAúwaben whereby the square appears in the circle. The appearance of the square in the circle is illustrated in the jellyfish *Clytia languidum* which is able to change into a square upon being touched/recognized.

Discern within the Collective Consciousness of united Names are four faces—one face from each side of the united pyramids. When we look at the sides of a building, we speak of each side being a face. As our Names are joined collectively, being a weaving of two strands, we emanate four faces [Yechezqel/Ezekiel 1:6-8]. In the Unity of Names, we are *in the Likeness/Damut of YæHúwaH* via which *we affirm our origin of Being* [The Collective Damut Adim, Yechezqel/Ezekiel 1:5; Sepher Maoshah BeRashshith/Gen 1:26].

From the inner foundational square there arises four sides. Within each side there are three houses which comprise a weaving of three four sided pyramids into one Teraysarun whereby there is a twelve sided construct of thought. These twelve abide within the ten lands/spaces of the circle. The Letter, Tæyth/⊕, depicts the three inner united teraysaruns amidst the ten lands. The twelve within the ten comprise the 22 letters of the Hebrew AlphaBet—the full communication of the United Teraysarun/22/4/Δ.

As one considers the numerical computations of the ten parts to a circle (see illustration), the united ten parts value is 26 or 8—the value of the United Name of YæHúwaH. Within the State of the Ten Lands is the Name of YæHúwaH unto whom all states of residence

The Mountain of YahuWah, comprised of a pair of joined strands at the base. From their four united corners arise the four faces in the Likeness of YahuWah.

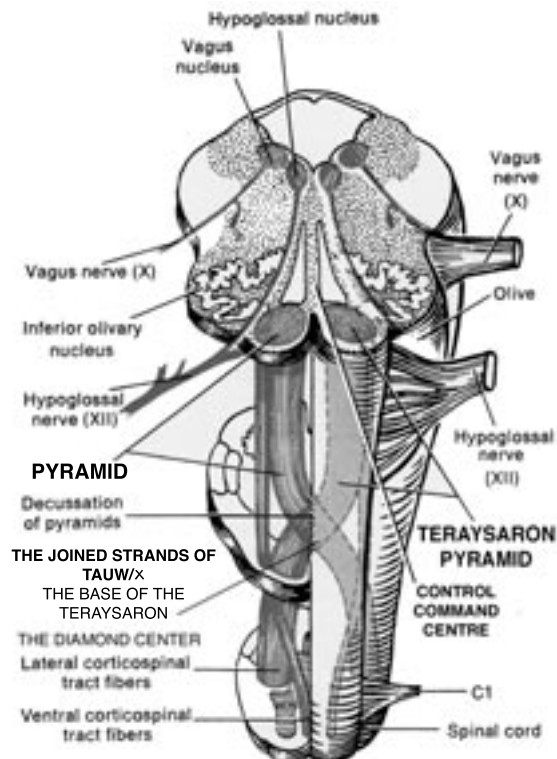

are built. In every level of residence we dedicate our members unto the Name of our origin whereby we move, live/ascend and have our Being. The ten lands are the full extension/10/1 of the inner twelve/12/3 which is the Residence/House of YæHúwaH, our eternal dwelling/Δ/4—The United Teraysarun. Out of the Teraysarun of four faces comes the full encircling of Ten Lands, thus out of 4 comes 10/1.

The full extension of the Teraysarun Thought is 10, the Yeúwd. Within the Teraysarun of Faces are the 12 branches of Thought known as the twelve tribes of YishARAL. The extension of thought and the twelve branches combine to render the value of 22 which arises from the foundation of 10/1 and 12/3, springing up from the Fountain of Wisdom in Aparryim in the West—the Dallath/Δ/4.

The words of the prophet are heard in the ears that are open: “Go up into the Mountain and bring forth the Wood, and build the House, and I will take pleasure in it and I will be glorified, says YæHúwaH [Chaggai 1:8].” **The branches of thought are the wood formulated within the Minds of enlightenment—the priesthood affirmation within all Names.** This pattern in with in the upper hills of our Names, preserved forever unto their unfolding.

The full extension of Mind and the Branches of the Name YæHúwaH comprise the House of One Name, being the combined three interwoven pyramids of The Teraysarun of Wisdom, Understanding and Knowledge. Each of the three Teraysarun are 4 sided and are interwoven as a cord of three strands of gold, silver and bronze. The Principals of each House are present within each of the four quadrants. **The One Principal amongst the Three Houses is named, YæHúwaH,** who abides in the midst of Wisdom, Understanding and Knowledge. The Teraysarun of YæHúwaH is comprised of the Totality/Taúwah/22/×, which reduces to Dallath/4/Δ, and is evident within 4 faces. The Faces of Totality are the East, South, West, and North, for these are the Faces of Breath/Light.

Full expressions of each Name expand into Three Houses. Via the expansion of each concept Name, branches are formed with which the House of YæHúwaH is built [ALphæh Sepher Melachim/I Kings 5:5-6]. Until the Names unite, they esteem their own Name above YæHúwaH. **When two strands of light/thought, combine their Names as one, they bring forth the 4 faces of Breath/Light.** From this point they are called according to the Name of YæHúwaH/אָפּאָל which is the extension/Hand/Yeúwd/ל of the United Lights/Hhúwa-Úwah-Hhúwa/אָפּאָ. Each strand has two ends as a branch of a tree/ץ/11. When the strands are joined together, they comprise the Letter Taúwah/×/22 and have now the intrinsic value to form the four squared base of the Wisdom Principal in the west. The foundation arises with Understanding as the sides of the north and south, and ascends without retraction unto Knowledge in the east—the Qadam or Origin of all things. As noted above, the Taúwah/22 reduces to Dallath/4. Together, the values of Wisdom, being of the single Numbers/22, and Her reductive Number of Understanding/4, form the word, Dat/×Δ, meaning the Royal Decree, אָפּאָל ×Δ —the Law of the Revealed Lamb/maShayh. This is the Law that is the union of Shayin and Oyin, Wisdom and Understanding. The Dat/×Δ is the value of YahuWah/26 **which houses Oyin in the midst of Knowledge/×OΔ—the fruit/seed/foundation of the Tree of Lives. The Seed is the reductive house of Light via which all things are carried, transmitted, and**



**perpetually renewed into all levels of consciousness.** The Letters of this Word of Unity are the sheath that covers all three houses into One House.

Separateness is a strangulation of the neck and cuts one off from the Mind of Knowledge. The access at the neck grants full disclosure of all within. The full expression and glory comes through the four sides of Knowledge that arise from the foundation. From all perspectives of the House we discern that **the foundation of four corners united, being a composition of two strands of Light, form a Body of Oyin which is fully extended by and occupied/filled with the glory of the twelve branches.** The original strands of Light are the strands of Chækúwmah and Bayinah which form the House of Light from which all Names are birthed. This pattern is in the Mountain of YæHúwaH, resident within the consciousness of every Name taking a form of ALhhim (see illustration of the pyramids in the medullah). In building the House of YæHúwaH, **we follow the pattern of our Origins.** We build the House from our intertwining of tribes that yield the colors, fabrics, wood, and bronze that are overlaid with the gold and silver that rises to the top from the base and sides.



**The ten or full extension of thought bring forth the twelve laden with fruit even as good soil will yield a harvest.** The ten reduces to one ALphæh/4 from which comes the sayings pertaining to “Three in One.” From One Seed—the Unified Thought in Beniymān/the 12th son, comes the Twelve Branches (12/3) which are the full communication/3/∧ within every state. Within the Seed is the power of ascension, the GammAL/∧, that arises into Writings and into the Sayings of the Amuwri. When a thought begins to arise/∧ it goes into our hand to be inscribed/↻ and out of the inscriptions come the Sayings/↻; this is the column of Letters, GammAL, Yeúwd and Paúwah. Or as a Saying descends it is written and the full Wisdom communicated.

**As a Thought is extended unto 12, the 12 is empowered or multiplied by 10—bringing it to its full stature or measurement.** In this perspective, the twelve are to the 10th power which is  $10 \times 12 = 120$ . The 120 is the cube of six sides empowered or filled with Breath displayed in the  $12/3 + 12/3$  which yields the joined Teraysaruns, head to base, as illustrated in the Magen Daúwid, commonly known as the Star of David. The 120 is where sweetness is found within the mouth of the bee and stored within the hexagon chamber, comprised of 6 sides in the inside and 6 on the outside, thereby being 12 [Tehillah/Psalm 19:10]. The empowerment of the 12 is the 120 which gather into the Upper Room. As the 120 arise within the Mountain (in the medulla), a spring breaks forth in the Valley of Wisdom and rises up unto everlasting life, eternally supplying the Branches with the waters from underneath. As the 120 gather in the Upper Chamber/Room, the Breath fills every chamber. Until the Upper Room is entered, the Branches are not readied to contain the Breath for the branches have yet to be joined to receive the glory. The 120 divisible by 6 = 20/Υ which are the paired extensions comprising the Tree of Lives.

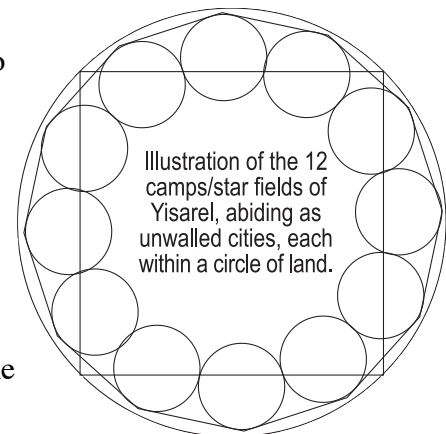

When we refer to the concept of being divisible, we are saying that one value is within another. When the 120 is divisible by 4 faces we derive the value of 30/ℓ the combined move-

ment of 15° per hour, both day and night, whereby the Lights of the 12 are regulated by the emanations of Yehh/אָה/15/6 to move in a circle. According to the emanations of Light within the circle, so are the Sayings of the Amuwri per day/night. In all of these calculations we are beholding how Words are derived from a Seed. A Seed branches, and as it does the properties are opened with the Nature of Yah/אָה/15/6 to yield the Unified Sayings of Light [Tehillah/Psalm 119 Section Paúwah verse 130]. The words that we speak are empowered by the natural Breath or the Breath filled with the Consciousness of the Mountain—the Reúwach haQodesh/Holy Spirit. The Voice of the Reúwach rises up within the Branches of our Name and unites them with the fountain of Wisdom unto everlasting life.

As the Lights of Day and Night move 15° per hour and per day, the tribes are brought into the path of Chækúwmah—within the path of the sun that arises within the eastern quadrant. For though Chækúwmah/Wisdom is seated in Aparryim, She arises in Yahúdah. As each tribe rotates into Her path, a work of light is designated within us which is called a Chodesh/month, being a cycle of the moon. The term Chodesh/WΔפּ—the work within the sides is derived according to Chækúwmah/אָמְפּפּ—*the Name/8/פּ that branches/פּ to disclose/flow with/פּ the Light/א* whereby all works/activities of the Teraysarun/WΔפּ are blessed with the fountain of Wisdom arising within them and blessed by the waters of the everlasting hills that come down upon them from Bayinah. Thus our branches are ever green and in each month we bear the fruit upon our Tree of Lives [Chazon/Rev 22:1-2; Tehillah/Psalm 1:3]. From every disclosure of Wisdom, the Amuwri Sayings flow to reveal the Unity Principles. The words of Understanding unfold the layers of light that are compiled each evening, whereby all composite thoughts are opened in the morning *oylah/offering* via the *kevesh echad/lamb* of agreement/oneness.

Every moon series of 30 days, within the seasons of the year, the Circles of Knowledge, known as the twelve encircled constellations, rotate upon the Base of Wisdom. The foundation of Wisdom is depicted by the square in the illustration. This foundation of the square is seen as the sun defines the four corners of the earth each day. As the camps rotate, they come within the face of the sun. As they enter into the Face of Chækúwmah they travel together in the path of the sun. The camps are likened to a crown of jewels upon the Queen of Wisdom. The 12 camps are within Chækúwmah at all times as they are arranged in their camps around the Mishkan/Tabernacle. As the camps of Knowledge march in procession above the base, they are gathered within the wings/sides of Bayinah. This gathering is depicted as the moon passes through them and encircles them. Chækúwmah undergirds the camps at all times even as the sun lifts up all things daily. Bayinah encompasses and gathers us together. Our gathering yields a glory greater than any one camp. Being encompassed together, with the Oyin Threads into One House, exceeds the parts. As the moon weaves in and out of the camps during the month, She knits the houses together with Her white wooly threads to form a garment of consciousness in which the camps are clothed. This consciousness of clothing is reflected in the landscape of the earth each month depicted by the color of the leaves, the fruit and vegetation according to the season, the coats of the animals, the snow, the ice, etc. We are to examine the various weavings of our organs, the types of vegetation and skins and how they pertain to one of the nine types of garments of the Letters.

# STATES OF LIGHT

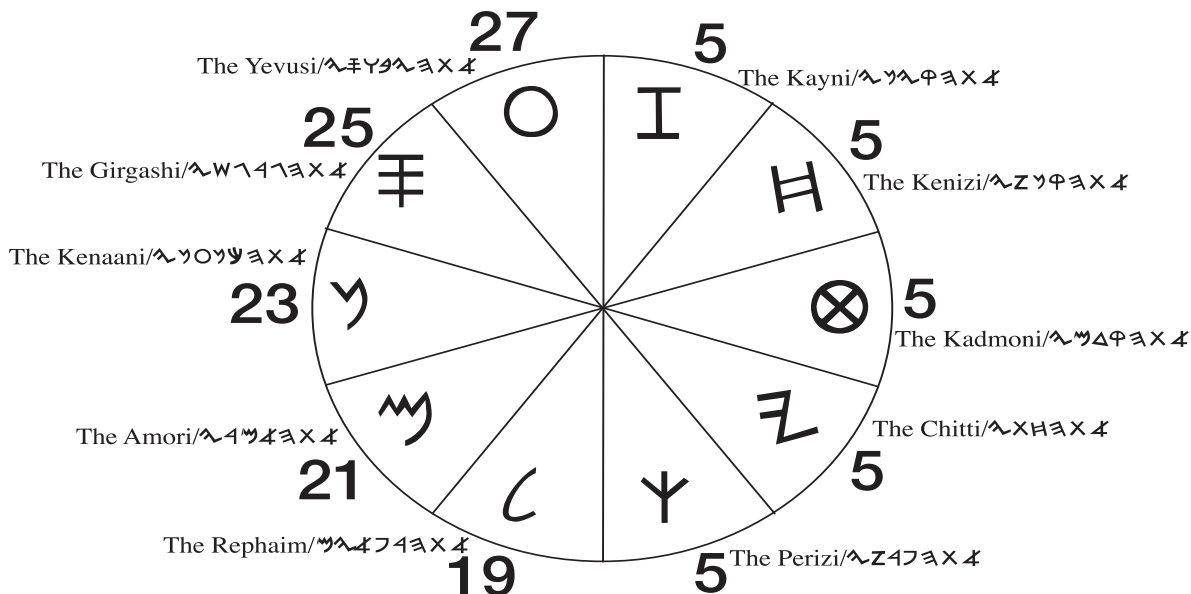

As one enters into the Union of the States of Light, the HaWawHa, 5+5=10/1, the perfect has come.

**The values of the Lands are added from the South to the North, for what is given from the North increases as it is given to the South:** Zayin+Lamed=19; Chayit+Mayim=21; Tayit+Nun=23; Yud+Samek=25; Kaph+Oyin=27. The values of Zayin to Oyin yield the value of the 7th Power of Thought—the State of the Amori. **The total sum of the ten Lands** is 115/7, from Zayin to Oyin = 7/Completion. **In drawing out the values (subtractive) of the North to the South as the value are given to the South from the North**, Lamed-Zayin =5; Mayim-Chayit=5; Nun-Tayit=5; Samek-Yud=5; and Oyin-Kaph=5. The value of the lights on the South are 25/7. The values of the North/115/7 and the values of the South/25 = 32, which corresponds to the eight gates (H x Δ) to the inner courts of Chokmah and Bayinah. The path of the 8 gates, 32, in which is the reductive of 5, affirms the paths to the 10 lands are the States of Light/5/א. The values of increase and the value of sowing/decrease, are both 7. The activity of the Lands, in sowing and reaping, affirm that these lands the Nun/14, being the union of the 7 of the North and the 7 of the South.

The circle of the twelve constellations of Lights move 360° during the day and night. They are positioned 30° within the Oyin consciousness via which they form a complete Oyin/circle of 360/9. Around each of the twelve encampments of Knowledge there is an Oyin measurement of land surrounding them. As the tribal lands of each constellation enter into the path of the sun, a new month commences, and its work is activated by the warmth of Chækúwmah. The month is dedicated to the fruit of Wisdom/Chækúwmah within that tribe. The unique activities of each light cycle is extended at the sides by the Presence of Bayinah, as the moon encircles and intertwines its path through all of the camps each month. The lands of each constellation receive from the

Faces of Bayinah as the moon enters into each camp for two or three days during the month to establish, develop and bring forth the traits of the fruit of the month. Bayinah is positioned at the sides of Chækúwmah, thus she rides above Chækúwmah in the sides of the camps.

The camps move 360° per day and also 360° per month within an Oyin/lunar circle as well as 360° per year. All movements in Light have a reductive value of Tæyth/9/⊕/consciousness for each day and month and year. The *movement within Oyin/the lunar rotation* is 12 moons/months per year.  $12 \times 360^\circ = 4320^\circ$  which are the *degrees of moving in the Oyin Body*. The movement per year also has the reductive value of Tæyth/9/⊕/consciousness of Light. The value of 4320 is a composition number: 43/7 and 32/5 combine as 12/3. The Primary Number of 4320 is 3 which indicates that within the camps is the full communication/∧ of Light. According to the ancients, a compound number may be read in parts. The number(s) in the middle, in this case, the value of 32 may be read either as 32 or 20. In that the earth circles 360° within the path of the sun each day, we derive by multiplying 360 x 30 days that we move monthly 10,800°/9 in the work of Chækúwmah, being the full extension/10 of HaShem/8. Per

## The States of Light

### The Three Cardinals of Ten—Complete Extension of Thought unto the Three Heads of Understanding The Cardinals of ALphæh/1 to Yeúwd/10—THE HEAD OF YEÚWD

#### The Assembled Letters and Numbers of Unity. The Extensions of The Ones

The Left Side/Hand	combined halves	The Right Side/Hand	
⌒ 5+5 (twenty parts/halves) = 20/2	20 + 2 = 22/×	⌒ .5+.5 (two parts/halves) = 2	
⊕ 4.5+.45 = (eighteen parts/halves) = 18/9	18 + 4 = 22/×	⌒ .5+.5 = 1 + .5+.5 = 1 (four parts/halves) = 4	
⊕ 4 + 4 (sixteen parts/halves) = 16/7	16 + 6 = 22/×	∩ 1.5 + 1.5 (six parts/halves) = 6	
⊕ 3.5 + 3.5 (fourteen parts/halves) = 14/5	14 + 8 = 22/×	Δ 2 + 2 (eight parts/halves) = 8	
Υ 3 + 3 (twelve parts/halves) = 12/3	12 + 10 = 22/×	⌒ 2.5 + 2.5 (ten parts/halves) = 10	
<i>Total parts on the Left = 80/26/8</i>		<i>Total parts on the Right = 30/3</i>	

- The combined Principles of the North/left equate to the Value of the Word/Devar/26 from which comes all Thoughts.
  - The Letters ÚWah to Yeúwd or 6-10 are summed up as 40/4 pertaining to the 4 Paúwah(80) within the Oyin.
  - The Value of 40 pertains to the House of Aharúwan that comes out of the North unto whom all Words are given.
  - The Principles of the Left and Right is the basis of the Tablet of 30 days in which are 4 weeks or 4 gates.
  - The combined Values of 26 and 30 are 56, which is the position of the Tree of Lives which reduces to the Kephúw/Υ which is in the midst.
  - The position of 56 is attained via the left/north side of the Letters, being 2 extensions beyond the parameter of 42. Thus we enter into the Tree of Lives from the North side.
  - The 22 is in the midst of the Hands, where we find the Kephúw/Υ drawn in the midst of the hands, via which we see both sides of the Tree of Lives.
  - The Value of 56 is comprised of two parts of 28, coined as B'SHAYH/⌒W⌒ The House of the Lamb.
-

## The Cardinals of Zayin/7 to Oyin/16—THE HEAD OF OYIN The Assembled Letters and Numbers of the Body.

### The Extensions of The Sevens

#### The Union of Two Sides, The Basic Numbers of the Hhuwa<sup>א</sup>/Uwah<sup>י</sup>/Hhuwa<sup>א</sup>

The Left Side	combined halves	The Right Side
⊥ 3.5 + 3.5 (fourteen parts/halves) = 14/5	14 + 32 = 46/10/⋈	○ 8+8 (thirty-two parts/halves) = 32/5
⊥ 4 + 4 (sixteen parts/halves) = 16/7	16 + 30 = 46/10/⋈	⊥ 7.5+7.5 = (thirty parts/halves) = 30/3
⊕ 4.5+.4.5 = (eighteen parts/halves) = 18/9	18 + 28 = 46/10/⋈	⊥ 7 + 7 (twenty-eight parts/halves) = 28/1
	20 + 26 = 46/10/⋈	⊥ 6.5 + 6.5 (twenty-six parts/halves) = 26/8
	22 + 24 = 46/10/⋈	⋈ 6 + 6 (twenty-four parts/halves) = 24/6
	year we move	Total parts on the Right = 140/5

- The combined Principles of the North/left and the South/Right equate to the Oneness, the Foundational Principle of Unity, Ten Parts = 1 Body.
- The Letters Zayin to Oyin or 7-16 are summed up as 115/7 pertaining to the perfect wholeness of the Oyin Body.
- The Value of 7 pertains to the full spectrum of Light within the Oyin consciousness.
- The Principles of the Left and Right are the basis of the 9 types of fabric which are emanations of the 5/Light of the South layered in the west.
- The combined Value of 90 and 115 is 205, a reference number to the Knowledge of the Lights, from the base of Wisdom thru Understanding.

## The Cardinals of Lammæd/12 to Shayin/2 —The HEAD OF SHAYIN The Assembled Letters and Numbers of the Kingdom.

### The Extensions of The Threes.

#### The Union of Two Sides, The Basic Numbers of the Ha/אUWah/יHa/א

The Left Side	combined halves	The Right Side
⋈ 6 + 6 (twenty-four parts/halves) = 24/6	24 + 6 = 30/3/⋈	⊥ 10.5 + 10.5 (forty-two halves) = 42/6
⊥ 6.5 + 6.5 (twenty-six parts/halves) = 26/8	26 + 4 = 30/3/⋈	⋈ 10 + 10 (forty parts/halves) = 40/4
⊥ 7 + 7 (twenty-eight parts/halves) = 28/1	28 + 2 = 30/3/⋈	⊥ 9.5+.9.5 = (thirty-eight halves) = 38/2
⊥ 7.5+7.5 = (thirty parts/halves) = 30/3	30 + 9 = 39/12/3/⋈	⊥ 9+9 (thirty-six parts/halves) = 36/9
○ 8+8 (thirty-two parts/halves) = 32/5	32 + 7 = 39/12/3/⋈	⊥ 8.5 + 8.5 (thirty-four parts/halves) = 34/7
Total parts on the Left = 140/5		

- The combined Principles of the North/left and the South/Right are three conveying the three levels of the Kingdom: Wisdom, Understanding, & Knowledge
- The Letters Lammæd to Shayin or 12-21 are summed up as 30/3 pertaining to Order of the Crown.
- The Value of 3 pertains to the Trustees of Light and the foundational Names of Avrehhem, Yitzchaq and Yaacov.
- The Principles of the Left and Right are the basis of the space of 3 which is in the midst of all of the seven rows of Letters for their ascension.
- The combined Value of 140 and 190 is 330/6, a reference number to ÚWah, the Unity of all Parts of Light—the Oneness of the Lights.

10800° x 12 months or 129600° which is a reductive value of Tæyth/9/Θ/consciousness of Light. The compound values in this number are the 12, 29, and 96. From the numbers we have a saying, that during the year, the 12 camps abide to study within the consciousness of the emanations/96/15/אפ/of YaH, affecting their branching which are in the midst/29/11/י.

Letters of Zayin to Oyin comprise an Oyin Duo-Consciousness Body—from the Zayin/tail to the Oyin/head. **In the midst of the 22 Letters are the ten lands, of the Zayin to the Oyin, designated for the Seed of Avrehhem**, which are the States of Light [see illustrations: States of Light]. This is in accordance with the promise of YæHúwaH: “**And to your Seed will I give this Land** [Sepher MeOShah Bereshith/Gen 12:7; 13:15; **15:18-21**].” The two hands of YæHúwaH, being of ten projections/fingers, become completely extended to establish the ten lands. We enter into these lands through the enlightened mind. Aharúwan is your guide into the lands which the priesthood has revealed unto all. With Aharúwan is the House of Yúwsphah (Joseph) which is the means to proceed into the Lands. This is what it means to carry with us the bones of Yúwsphah. As we enter into the lands, the generation at our side is of the House of Aphyraim (Ephraim) via the Name of Yahushuo (Joshua) Ben Neúwn. Neúwn is the 14th letter of the ALphæh Bayit with a reductive value of 5/Hhúwa/א; hence it is not pertaining to the flesh of Aparryim but the Light of Aparryim that brings forth the Principles of Beniyman to make the transference. Via Yúwsphah the promise is fulfilled: “And to your seed will I give this Land,” for through Aparryim, the seed/Beniyman, is appropriated into the Land.

With Aharúwan/Aaron is also the House of Qahhath. Why? Qahhath is carrying the vessels and the mind/illumination of Aharúwan forward each step of the journey, which sustains the camps unto their destinations. The House of Qahhath carries the Arúwan/ark whereby we make the progressions in our midst. Via the hands of maShayh/Qahhath and Aharúwan we extend all of our members into the States of Light. The value of Neúwn/14/5, coming out of Aparryim, arises as we combine the Teraysarun of Chækúwmah and the Teraysarun of Bayinah, forming the pyramids within the medulla. With the complete Lights of the Queen of the South and the Queen of the North, **we speak concerning the levels of our inheritance via the Amuwri State.**

The **Amuwri State is the seventh position** of the Oyin dwelling. *Each land state is a means of empowerment from one to the tenth power* whereby all of being one is fully extended. The empowering or multiplying increases extends the Principle within each thought land to convey the full extension of Unity. As soil is the means to empower/develop a seed unto a mighty oak, so are *the lands of our inheritance the means to empower the branches of our Name and the Seeds that are born upon her branches*, upon which Her leaves—letters/words are fully communicated. The “seventh power” means to swear/*sheva*/O᠑W a value—to bring up a value unto its complete expression. Each thought during the four quadrants of the month are brought to the seventh power each shavbeth wherein it is perfected/completed in the Bread of the Presence. Concepts rise within the days one through six, but on the seventh day, they are complete.

When a word is spoken to the seventh power, it is an oath that establishes bonds that cannot be broken. The words of YæHúwaH that pertain to the covenants are spoken to the seventh power whereby they cannot be broken nor nullified. What we speak to the seventh power is an oath or a promise which verifies our Mind of agreement. One enters into the seventh power as

they give themselves completely to YæHúwaH, wherein the echo is heard within our consciousness of all that YæHúwaH speaks in our hearing.

Via an Amuwri utterance, one is sworn/seventh powered to abide within an unbreakable oath of promise to abide together in YæHúwaH. Thus as every Name arises from the Fire of Chækúwmah they are sworn unto another Name in the Mind of YæHúwaH. This bonding is the welding of two strands as two strands arise and intertwine from one flame. Via the swearing of Names one enters into the seventh or complete State of Thought, for until the bonding occurs there is an incompleteness to know the perfection of Thought. Swearing is *lit.*: the Fire/W bonding/᠑ unto a level of Oyin consciousness/O—the State of the Oyin which has no beginning nor end.

Within the Oyin lands we come to open up all that lies within the consciousness of our Names of Light. The lands are given/extended from our Names as we seek to extend the unified base of our foundation. The Principle of the Oyin that is in the midst of our Names begins to swirl forth to encircle like a whirlwind until all that is of our Breath is caught up together with Her and carried by the Breath into the very Nature of Breath. Count the spaces between a word and the spaces between the letters to behold the Presence of Oyin/70/16/7 or any combination of spaces and letters that equate to the numbers of Oyin. For example, take the word, devar/4᠑Δ which comprises the value of 26/8, the same as YæHúwaH. Thus every word that proceeds from the mouth of YæHúwaH is according to the Name of YæHúwaH, as Tehillah 138:3: “For you have made great/empowered/nurtured that which pertains to your Name to branch your sayings/ words.” What every YæHúwaH speaks is empowered to increase from the one to the tenth power. Within the word the numerical value and the combination of spaces and letters releases the Oyin or the Understanding that is within each Name/Word. In this example, a word is that which is of the value of 8 in that the Dallath/Δ/4, the Bayit/᠑/2, and the Rayish/4/20 comprise the reductive value of 8, and likewise the spaces are 2 between the Dallath and Bayit and 18/9 amidst the Bayit and Rayish which yields an 9. Together the 2 and 9 = 11/2, which when joined to the letters comprise 10/1 according to which a word may be spoken to the one or the tenth power—the Unity of YæHúwaH.

### The Coming unto OYIN MISHPAT/᠐ᠮᠢᠰᠢᠫᠠᠮᠤᠮᠢᠰᠠᠮᠤ ᠮᠢᠰᠢᠫᠠᠮᠤ

The Kings gather in the **Oyin Mishpat/Eye of Judgment** [Sepher Maoshah BeRashshith/Gen 14:7]. As you proceed in uniting and regulating your houses, you come into the *Oyin Mishpat* together with the Kings. ***The authority of one’s consciousness governs all states of development in space and in words*** and becomes apparent with understanding and with words.

From all that we conquer, as we move from one level unto another within the Oyin Lands, we take up our position of dwelling. At each level of State of Residence we appear/ become manifest **according to our collective thoughts unto The Oyin Mishpat—The All Seeing Eye of Judgment**. The Oyin we deem to be the Bayinah, the Queen of the North who sits on the Throne of Judgment via which She rules all things. Hence, we may say, by deduction, that according to our levels of progressions, so are the states of our dwelling and none need to despise the habitation where they abide, for each place is an avenue unto mastery.

To say Kings gather unto the Oyin Mishpat pertains to all governing Principles of Authority gathering within the Court of the All Seeing Eye. From all that we gather, so we judge our acquisitions and we are judged by what we are acquiring. From our judgments/evaluations we are able to invalidate (smite) all resistance of the Amaleq and also the sayings of the Amuwri that are dwelling in Hatsetson-Tamar/ *Ḥatsetson-Tamar*, which means *in the partitions of the heart*. The *partitions of Tamar* pertain to Understanding, i.e the date palm which conveys a pillar, being a construct of thought denoted by the strength and majesty of the palm tree.

As we take possession of any object or any group of thoughts, we are judged by our holdings. Whatever we touch, accept, carry or agree with, we are judged. For as we extend our hands unto the State of Unity, we are judged to be amongst those of the Court. However, as we extend the hands unto the state of division, we place ourselves to be overthrown.

We are responsible for all that we hold and or carry from the elements. In all that we carry there is a consequence. **A reward, that being a crown, comes with our accepting the responsibility regarding every thought and deed.** We are responsible how we use what we carry/hold/transmit. Even every glass of water is a means to discern, reflect, transmit thoughts, and every breath of air is the means to exchange our thoughts that we carry, hold, or transmit. We are responsible for the water, the lands, the air, and the fire. The waters carry all things as a membrane via which we mirror our thoughts. The lands determine the space in which we cultivate our thoughts and from which the fruit rises. The Fire is the means to elevate and to reorganize our thoughts and dwellings. The air is for us to expand our thoughts and the Faces of our Names in Rúæch.

Via all that we take/accept/learn there is both a **volume/space** and a **density/weight/ value**. **We are measured according to what we accept and learn, for this affects our growth.** *Volume and density are the basis for each Letter and Number.* Each letter is a Principle of Space in that it is a thought, and every thought occupies a space or volume. Each Number is a value, those with paired numbers belong to the Nature of Light and those with non-paired numbers belong to the unclean. Hence, this is the distinction between the clean and the unclean. **The clean belong to perfect associations of thought, and the unclean unto the imperfect/incomplete constructs.**

Each Letter/volume has within it and carries a Number/density. **The Letters of ALphæh to Taúwah are the traits of ALhhim, for they have within them associated and paired values.** According to the Number of the paired thoughts so is the glory/density that they carry and maintain. **The two aspects of volume and density are the means to expand or solidify, to fill or to empty.** With the density, we determine the substance and express the value, concentration, weight which pertains to the glory of the thought. The glories of ALhhim have weight via which they are suspended together, yet they are not bound nor enslaved as the members within the flesh which are bound unto the mortal. The ALhhim are free to be transposed within Breath which is according to their Nature. Hence, when we say **the ALhhim are in YishARAL**, we are speaking of the categories of Light in which the ALhhim reside in the soul members, and are not referring to the weight of the mortal but rather the glory in Breath.



The Letters in the three columns of Understanding lead us into the 70. From 42 to 49 to 56 to 63, we proceed unto 70. These are 4 levels, being an inner square of thought within the three levels. The Letter Taúwah/22/4 is the sum of the 4 sided square. The Taúwah can extend itself via the other Letters as each is summed by joining all of its parts. In adding all parts of the Cardinal Letters, there are 690 parts or 15/6, the inner structure of Semek. The parts are referred to as subLetters or classes of ALhhim within the 22 Classes of ALhhim. The Nature of ALhhim is according to the square within the Oyin consciousness. Anything of ALhhim conforms to the cube. There are 192 Letters on the cube being a 12/3: the Letters of Wisdom, Understanding, and Knowledge. Together there are 22 Classes; plus the 28 Letters in the upper levels; plus the 690 parts; plus the 192 Letters on the cube, minus the 22 lest we count them twice on the cube, a sum of 910/1 which is a ONE. Take all to the tenth power, to the hundredth power, and to the thousandth power, the sum is ONE. There is ONE LETTER, the NEUWN, there is ONE WORD, AHHAV, there is ONE LIGHT, ONE FACE, ONE NAME, ONE TERAYSARUN, ONE GLORY, ONE ROCK which we affirm daily as we transpose into QudashhaQudashim (Holy of Holies). More Letters are a consideration to be understood with caution for there are other letters that are abominations—the veils of these bodies. These strange letters form strange garments until the Names within are joined into a square whereby they have the foundation to arise unto the new generation.

In that we seek to be the weight of Breath we are weightless, being without burdened by offenses and the weight that comes by holding on to materialization. The burden that we carry are the Names of our tribes upon our shoulders, and though they have glory, they do not weigh down any member, nor are they the weight of mortal mass. When we bear each others burden, we support each other according to our Names and not by the weights of another's struggles and thoughts of oppression.

Yahushúo discusses eternal lives with a rich young ruler. Being young is not a description of age but rather denotes a level to quest/inquire—one seeking to learn. The quest of the young is “What must I do to inherit eternal lives?” **Eternal Lives are perpetual states of the Oyin which have no beginning nor end. The lands of eternal lives comprise Oyin States of residence which are prepared to house our Seed;** hence to live in the Lands of the Oyin one becomes free of struggles and strivings within the collective mortal mass of humanity. The aged are the kings and counselors which have entered into Life and ceases from struggles and need for dominance [Eyov 3:14-15]. *The Oyin State is where all is One and all is One, where Kings reside*, who have taken from the ruins silver and gold and constructed houses which have no corruption.

In the mortal we struggle with the affairs of the world—with our bodies and possessions from which comes wars and conflicts. The world is the path to death; whereas the path to Life is being free of materialization. What we share in Life comes to us freely. [I Corinthians 7:29-35]. What we use, we do not make full use of it as though we think it will continue, for it is passing. If we have married in this realm, we are to consider that we are not married, for we are not bound unto the forms of this habitation. What we buy we do consider that we possess, for we are not devoted unto things but unto YæHúwaH. We take no thought of that which we will wear or eat for we know that what we wear is provided by the lights around us and via the Breaths that we wrap our-

selves. What we eat is of the light—the thoughts selected for us each day via the grace/favor as we make *the oylah offering* each morning and evening [TeuwratHhaKuwahnim/Lev 1; ChameshHhaPekudim 28:1-3]. There are four measures of grace: a) the grace to extend oneself; b) the grace to arise with strength; c) the grace to walk in the illumination; and d) the grace to fulfill our Words.

**We invalidate resistance that keeps us from the Throne of the Oyin Mishpat, and we invalidate mediocrity of words that have no value/no weight/no glory.** The term *to smite* means to break open resistance and break open the next set of words contained within the fields of Illumination we are approaching to enter. The invalidation at one level leads to a smiting, a cracking open of the door unto the next level. As resistance is smitten, doors open, and from the bins of grain, we begin to fill our sacs as our tribes come to Yúwsphah for their next measure of learning/infilling.

The *Oyin Mishpat is called Qudesh/Kadesh* for it is the throne set apart unto the pure judgment of thought. **Kadesh** does not pertain to the seat of materialization nor is it a chair of partiality, for none can enter in the Oyin Mishpat to cleanse/evaluate their holdings if they are of partiality or questing for that which is passing away. The phrase in Oovri/Hebrew is “*unto the Oyin Mishpat, She, being as the chair from which the Principles are written, is Kadesh.*” In the consciousness of unadulterated thoughts the judgment is written and detailed within the Kadesh fields, those holy devoted to the Oyin Mishpat. From the statements written at the judgment of the Oyin Mishpat, we arise and smite. We break open the resistance to our next progression, and the sac of concepts upon which we will feed flow unto us.

**We become apparent before the All Seeing Eye of the Queen according to our collective thoughts.** Bayinah does not look upon our outward nature but examines that which is held inwardly; what we hold inwardly is the sum of our being. As we gather all thoughts unto the Oyin Mishpat—the All Seeing Eye—so we empower to invalidate resistance of Omaleq/Amalek and the hurlings of the tongue. Omaleq is the resistance before each succeeding gate and before each avenue to ascend in revelation. The resistance is felt as you seek to penetrate the next level of illumination. You know there is more of Breath to enter, thus you continue to pursue. From all laid at the foundation at your feet you have the footing to proceed higher in the mountains of the South and North. The resistance is broken as you commit all thoughts unto Oyin Mishpat. With the breakthroughs so do the river of words, held by the Amuwri, flow freely to articulate revelations at your gates.

### **Smiting the King of the Amuwri/Amori**

The king of the Amuwri is Sichon/𐤎𐤍𐤏𐤍. When you capture Sichon you possess all that is within the land of the Amuwri. Acquiring the Ten Lands at three levels form the Lammed Rule of mastery of your Name. Then the end comes, when Your Name hands over these domains to ALhhim the Father after you conquer your Wordstates of habitations, by authority of your Numbered Name and power of your Spirit. For you are to reign until you put all enemies/friends under your feet (I Corinthians 15:23-25). King Sichon pertains to styles of

speech. When one speaks with the tone of Sichon they speak of an orientation of this world as being real and as though this world has no end. Speech is based on comprehending the Letters in Words. The natural mind, as a king, reigns within a body of flesh and speaks body language. As you conquer the natural mind, you come to transform the mind from natural inclinations to spiritual pursuits.

Professions have a way of speaking to characterizes their position. There are the words of the court and the words of the street, the words of the office and the words in the factories. Each profession has its set of terms and a mannerism of speaking. All of these styles of speaking are under the category of Sichon, king of the Amuwri, whereby the function of speaking is regulated by the positions of this world.

One may speak harshly yet be of a tender heart. The means of their speech does not mirror the Nature of their Name, but rather the style of speaking that their minds are molded. When one captures Sichon, then every manner of speaking becomes subject to the Nature and Number of Name whereby the former manners are subdued. Within the manner of speech, the words are structured/𐤀 to extend/𐤁 the value of eight/ascension/descension/𐤂 of thought unto unfoldment/𐤃 its Light Nature. The value the Name, Sichon is 47/11. The reductive value of the Name, Sichon, 11, is the same as the Values in the midst of YæHúwaH/𐤄𐤅/11 and in the midst of the Garden of Letters/𐤆/11. The combination of spaces in the Name, Sichon yields a 12/3, which pertains to the construct of a Teraysarun, being a Unity of three Houses of Wisdom, Understanding, and Knowledge. The TempleBody of Light is the construct of thoughts/words that we speak as we enter and reside within the Amuwri land. We take the lands by quarters [NechemYah/ Nehemiah 9:22] according to the quarters of the Paúwah that designate each work/month. The terminology of Knowledge is to possess according to the *chalaq l'pay'ahl* 𐤃𐤁𐤇𐤈 𐤌𐤏𐤈𐤁𐤇—by the portions of the lips/edge/mouth. These quarters are according to the four periods or watches of the night, being ruled by Bayinah. Via Sichon we convey the sides of a thought and speak concerning the nature of the four sides of the Teraysarun of YæHúwaH.

You move into the Oyin Lands as you first speak according to these lands. The worlds of Light are formulated according to the Words of YæHúwaH. As you speak in accordance with the worlds of YæHúwaH you construct your residence within the Lands of Oyin. The world of the nature of flesh is according to words of Babel—a construct to house Names of ALhhim to assemble/manifest as one people.

One of the greatest battles that one wins is regulation of the tongue and developing speech patterns according to the Minds of Light [Chamesh haPekudim/Numb 21:13-34]. The mastery of Sichon is sung over and over in the scriptures, more than the victory over Metsryim or any other power that YishARAL encounters in their routes to the lands of Avrehhem and the patriarchs. We weigh with jugements the Lands in which we are entering, to know their numerical values and the thought patterns that distinguish them to comprise the Oyin Body of Ten Rings. It is coming to Oyin Mishpat that we view correctly the lands and then weave them into our consciousness whereby our houses move into them and take up residence quarter by quarter. Following the mastery of Sichon, you come to possess Og of Bashan, for the form that Sichon rules and which is made by the words of his mouth fall into your hands likewise.

In possessing Sichon/𐤑𐤃𐤍𐤏, we consider the Letters that comprise the Name. In each Name acquisition, via birthing the Name within you or by acquiring the Name with silver/Understanding, you conduct and extend your thoughts within the structure of Light pertaining to activations of Names [Sepher Maoshah BeRashshith/Gen 17:13].

In the Name, Sichon, the Letter *Semek*/𐤏 is the consideration of the structures of Light in which we speak and are moving. There is a reference pattern—a Semek to all words, and this reference is the structure of illumination in your bones in which you are dwelling. As every planet has its web of orbit, so it is placed there according to the structure of sayings in the Mind of YæHúwaH. The structure of your thoughts is the pattern whereby you make transitions from one state unto another.

In the Name, Sichon, the Letter *Yeúwd*/𐤅 is the means for the structure of your thoughts and words to be extended within your Unity base. Via the Yeúwd/Hand, one functions, serves, and fulfills the words of Light through deeds.

Also in Sichon is the Letter, *Chayit*/𐤃 whereby the Principles/Seeds within the words rise up and provide nourishment/bread as you extend your Name of ALhhim into seven levels of Oyin. Through each Letter that you possess by Name, either via birth, as the Name of your Breath, or via birthing the Names within you, or via acquiring Names through silver, you come to possess within you the fullness of ALhhim unto the full measure of the Heads forming within you unto the Knowledge of YahuWah [Colossians 1:19; 2:9-10]. Via the Chayit/8, you rise up and dwell elevated by wings of the Oyin Body. One rises and sets daily with the sun and rises and sets nightly with the moon in her stars. Via the Chayit one rises into spirals/whirlwinds of the Ten Lands and swirls around themselves garments of Understanding. Upon the Yeúwd—the wings, one soars and is carried into the seven wildernesses of Transmitted Words/Sayings to come unto dwellings of ALhhim.

Consider also the *Neúwn*/𐤎. Via your words you unfold all States of the Amuwri/Amorite lands. As the heavens are stretched out, so is your seventh land stretched out within your habitations. All that resides within you—every Name, Word, Letter and Number, are drawn out fully, as garments unfolded. As long as the garments are yet in your body-closet, you are not wearing them. As they are unfolded via the oylah, you put them on and robe yourself to walk in the grandeur of the Light.

Next consider the spaces in the midst of these Letters of Sichon/𐤑𐤃𐤍𐤏. There are four spaces in the Semek/𐤏 and the Yeúwd/𐤅 attesting to the foundational base and full access within every structure of thought and deed. The four spaces between the first two letters forms a Dallath/4/Δ. As one performs within the structure of thought taking residence, further doors are open. All within the structure is accessed as you obey and perform to show you are in accordance with the structure of Light. There is a Letter ALphæh/1/𐤀 amidst the a space between the Yeúwd/𐤅 and the Chayit/𐤃 via which you expand from each deed of the Amuwri and become elevated in consciousness of ALhhim. As you are given access through the Dallath, you acquire more concepts/Principles/ALphæh. Using your members, according to Light, positions them to move and rise with inner and surrounding Illuminations. Conversely, as you use your members

for outer darkness they operate within the realm of deeds of outer darkness. Thus, as one walks in the Light in their Name, they enter into spaces of the Hhúwa/5/א amidst the Chayit/ח and the Neúwn/נ. With each ascension and unfoldings comes more illuminations. Thanks be to ALhhim!

Our internal spaces are  $4/\Delta + 1/\text{ך} + 5/\text{א}$ , **via which we extend our Name of Light through words.** The spaces reduce from 10 to 1, attesting to the Unity of all Words residing in the Oyin spaces/lands in which we dwell. **Thus, spaces in the midst of the Letters of your Name is space allotted to your Name for expansion.** Combining the value of the spaces with the value of Sichon/47, the total value of Letters and Spaces is  $57/12/3/\text{א}$ .

Via our words, we possess mastery, the king of Sichon, unto all communications of Light.

In visions of Avrehhem [Sepher Maoshah BeRashshith/Gen 15:16], the Houses of YishARAL are bound unto Metsryim—unto a land that is not of their configuration **until the fourth generation—the era of light inquiries**— $\text{ל} \text{ו} \text{ל} \text{ג} \text{א} \text{ א} \text{י} \text{ד} \text{י}$ . In the fourth generation they are transformed/become restored/return to the Knowledge of ALhhim and to the Land to which they belong. For until the *Awon HaAmuwri*/ $\text{ל} \text{א} \text{מ} \text{ו} \text{ר} \text{י} \text{ א} \text{ו} \text{נ}$  is complete, they are retained as strangers in foreign lands. The iniquity of the Amuwri is completed when the perceptions of The *Amuwri/Saying*/ $\text{ל} \text{א} \text{מ} \text{ו} \text{ר} \text{י} \text{ א} \text{י} \text{ו}$  become completed within the consciousness, whereby one arises and gives testimony of all that is beheld/ $\text{א} \text{י} \text{ו} \text{א} \text{ א} \text{ו}$ .

The fourth generation of Names goes beyond the Knowledge of this world. They exceed the parameters of the Letters and the definitions of this mortality. They transition via inquires whereby they gain insights into the realms of the Oyin. They do not walk or think as those in the natural world nor according to their design, but via the Nature of Light. Bet HaShem Midrash is for this purpose—an inquiry school—to direct the minds and hearts unto the thoughts of **the Túwrahh—the writings that contain all levels of Knowledge in Light.**

Included in the inquires are inseminations through which the inquires flourish, for until a seed is planted in the Land, we cannot bear the testimony of that which it will bear. The fourth

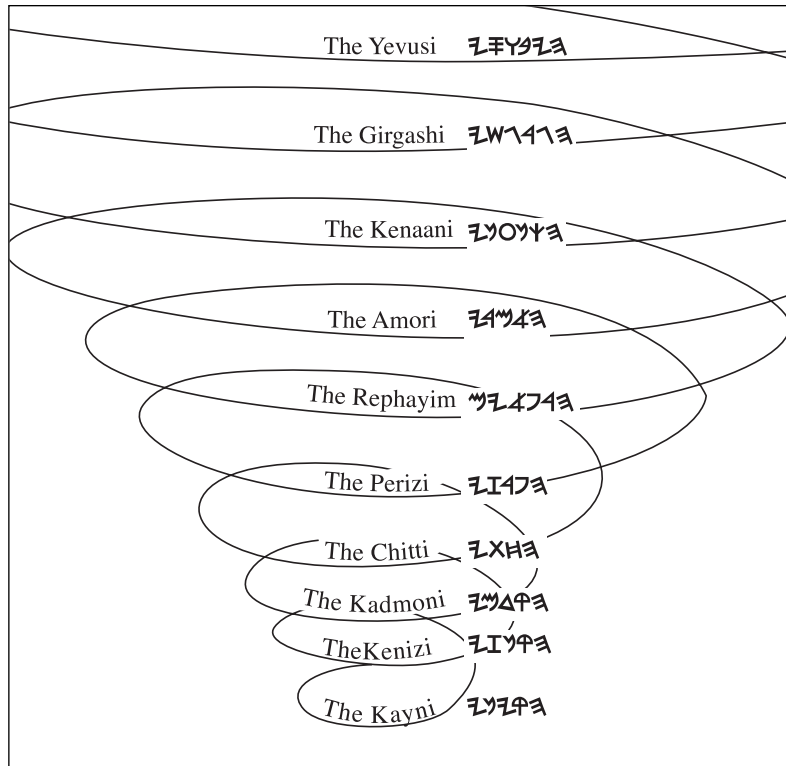

The Ten Lands/States of the Fathers imparted in three levels for expansion of Seed—Avrehhem; for joys of abiding by Name—Yetschaq/Isaac, and for the glories of your Name in Yaoquv to appear from your origins.

generation becomes transformed through bringing forth the side of Yúwsphah unto a new state. As we complete the perceptions of the Amuwri, we fulfill the ancient sayings of Light and shift from the sayings of confusion/mortality, which come to an end, unto the Sayings of the Oyin which have no end. What do we mean by “The Sayings?” All that the eyes see is to be perceived according to the word base of being and not by the object or form that is projecting itself above the internal construct. Inquiries lead us to fully perceive the Sayings/haAmuwri within us—**those inscriptions that are written with the Letters of ALhhim and within the white spaces of every word via which we discern the intent and the structuring of thought in the combination of Letters.** *As we read the spaces amidst the letters we discern the activities of Light that each word carries via which the Light within the words break open and we enter into the realms of Light.* We speak and read all in the Name of YæHúwaH whereby we behold the word structure of all ordered/arranged and discerned by the Mind of Wisdom. The Mind of Wisdom includes the Judgment of Dan, to know the patterns of YæHúwaH, for without knowing the patterns we do not know the correct arrangement of thoughts and their groupings [Sefer Yeziat Metsryim/Ex 35:34]. Via the Mind of Wisdom, we are the Lions of Yahúdah whereby we know the Numbers/Values that compise all thoughts and whereby we govern with every value of Light. Every thought has a corresponding Number/Value to be implored and exercised by our Names. With Yahúdah is the Head of Yúwsphah via which we compose all States of Residence and know the lands to which each thought belongs. The Head of Yúwsphah expands every thought with blessings. With Dan is the Head of RAúwaben, to know the Principles of ALhhim via which all things are forever renewed and never perish. The Sayings are the total expressions of Wisdom. When all has been perceived pertaining to Oneness, then we give testimony of what they are beholding. Via the Amuwri, the Túwrahh tells us of our fulfillment of journey.

### **The Coming of the AWON AMUWRI/AMORI/אָוֹן אַמּוּרִי**

The word iniquity/*awon*/אָוֹן is the same as a soothsayer—one who looks into things to read what is in a life and progression. When perception falls short, the reading is an iniquity— incomplete, unfounded. Being considered incomplete/unfulfilled one has yet to state what is coming appearing into reality. The eyes are short sighted which therefore affects outcomes/progressions/results. Iniquity in this sense is not able to see the end from the beginning and reveals that something else in the eyes. We turn to the Oyin Misphat—Dan’s Judgment of Understanding to gain clarity. When there is a mis-connection to the Origins of ALhhim and their fulfillment, then an iniquity yet remains in how WordNames are read and taught whereby offspring of Avrehhem remain in lands that are not theirs—yet to enter their ordained destiny of Ten Lands. The iniquity of the Amori/Sayings must be resolved/completed prior to YishARAL entering into their states of glory. To see that which is within, as the 12 outside of the Body, is the incompleteness and iniquity of the Amorites. The bastardization of sayings is so plentiful in the hands of the rulers of darkness, those who govern by turning what is inward to outward situations. Such remains until a fourth generation—a level of inquiry breaks the iniquity.

As inquiry is discerned and heard, it unfolds unto prophecy to reinstate the Words when your Name is birthed from the Faces. You record the Words of the Fathers within your Name and carry them in your satchels. Regarding entrance into your destined inheritance of Avrehhem, the white text reads: **for yet to be complete is the vision/beholding/perceiving of**

**your results of promises, whereby the full extensions of the Sayings, as to how far they reach, are restricted due to incomplete perceptions—forming an iniquity/awon/אָוֹן.** The black text of these words read: “Then in the fourth generation they shall return here, **for the iniquity of the Amuwri/Amorite is not yet complete** (SMB/Gen 15:16).” The SEED of AVRE-HHEM in YishARAL remains in foreign lands until the fourth generation—until you see and comprehend your Name in the Faces of Yehu. Through inquiries into the Sayings of Amuwri you gain understanding of Words of their becomings. As you have the Word, you move by the Words. The Sayings open to see all held within your 12 houses whereby the revelation of who are YishARAL is complete! When the Sayings written within your stones are perceived clearly, you bear testimony with pleasure in your eyes. ***The Sayings of Light become seen, understood, whereby they are entered*** [Rom 1:20-23].

Hearing the Words attunes us to vibrating message within the thoughts of Light. With such testimony there is pleasure and profit/אָנֶפֶט in connecting with messages of our destiny, as they are understood to enter. In beholding the Saying it can be spoken clearly, written and performed through which it fully appears with its glory. When the Sayings are not beheld iniquity remains; a gate remains closed to pass through. As the Saying/Amar is clarified, the glory in the Word radiates within us. The fourth generation inquires after to read Sayings in all formations of Letters. The testimony or evidence of what is seen becomes spoken and performed. The word rising from the foundations of Wisdom—reasons for being—comes to the heart with pleasure and great benefits/profits to be obtained. Light sayings are for profit/pleasure/acknowledgement of the harmony between Sichon and Og, between Words and their lands/states of residence.

The Túwrahh speaks of the great profit in terms of pleasure/joy that comes by acknowledging Wisdom’s display and the manifold expressions of light released through words. Until the word construct is perceived according to the light nature essence, it cannot therefore release the light that it holds. The characteristics of the fourth generation is to inquire into the Amuwri of Wisdom in everything, to behold the Nature of Light within, to know the operations and works of Light, unto giving full testimony—the evidence of the unseen rising within. Would there be any greater joy or gladness? In having full inquiry into all words one enters into the perfect consciousness of YæHúwaH and participates in the works of Wisdom. This is the high calling in your totality of being *mashiyach/anointed*.

Sichon is the king of Cheshbon/אֲשֶׁר־בְּחֶשְׁבֹן, the Amuwri [Mishneh Túwrahh/Devarim/Deut 2:24]. **Cheshbon is the center of the kingdom of the Amuwri**, just as there is a center within every land and within every Name, namely the Oyin. The Oyin swirls to encompass all within assembled as the path of a whirlwind. When the prophets speak about a whirlwind, they are referring to the spiraling winds of Bayinah that are measured from one to the tenth power in height or width. When one captures, Sichon, king of Cheshbon, one takes control of their tongue ***to determine values and express computations. Cheshbon is the means of computing words.*** Via meditation in Nephethli we reckon a thought or value to be spoken in Gad. Cheshbon is how we think to convey what we mean which becomes expressed in words. Via numbers, the sayings are composed and understood. Their intrinsic values become evident in analysis of thought.

The lands of the Amuwri are given unto three primary tribal camps: Gad, RAúwaben, and Maneshayh. Each of the lands are given unto their utilization for they are spaces of thought in which the Wings settle down and make their nest. We are carried on Eagle's wings to our destinations—that is, what is carrying our Names are the wings of Wisdom and Knowledge that rise up and lift us through the wilderness—word development, scoping out the place of our nestings/residences.

The ten lands, each of three levels of expanse, joy, and glory are according to the Names and their traits of the 70. The values of 10, being the full extension of 1, convey that the lands united are One Land in which the Consciousness of Oyin/70 abides. The lands are measured according to the consciousness within each Name.

*The Amuwri, the land of complete communications of speech and thought meditations*, is appointed for the House of Gad [Chamesh haPekudim/Numb 32:33]. Gad is the chamber of the mouth that speaks of the fortunes of Wisdom, Understanding and the values of Knowledge arising from Nephethi. Via Gad one speaks of all matters of the Mishkan via the 7 family Names of Gad which correspond to the seventh position of the Amuwri. Speaking according to the seven family Names is perfect/complete speech.

The space of the Amuwri is also given to RAúwaben, for all words and sayings are in accordance with perceiving the Principles, concepts and idea. Upon seeing them, they expand within us according to the level of sight. Via RAúwaben, Principles are gathered by the eyes and are fully discerned by Dan. RAúwaben dwells in the Amuwri, for the eyes are designated to Principles/Concepts of Words. The land is dedicated for the many concepts/cattle/holy Principles for RAúwaben. Via housing and meditating upon ALhchim, words flow from RAúwaben to Gad.

The Amuwri are also given to Maneshayh—to one half of the camp whereby we make transitions in Light. The House of Maneshayh dwells in the Amuwri for it is by words that we make transitions and carry forward the seed unto new states of illumination. Via word formations we shift our residences in the galaxies of Light. Maneshayh is the seed bearer of Understanding into new states through which we fulfill our labors of Yishshakkar. We serve in the lands as we are called and Named by the Court. Through Maneshayh we make transitory movements with the light as it marks out the twelve hours of a day in order that our deeds/activities be of the twelve hours of the day [Yahuchanan/John 11:9]. In walking in the twelve hours we have active within us all of the camps of YishARAL to express the composite sum within our branches.

Out of Maneshayh comes the oil for the lamps, whereby we walk in the twelve hours of the day and in the 4 openings/watches of the night. Maneshayh gathers the oil from all of the tribal thoughts to keep our menorah cups filled. As there are 70 Names of YishARAL and 70 cups that comprise the menorah, there is a flow of Understanding coming from each Name to contribute to the menorah. Upon the branch of Maneshayh the fruit of the olives hang on our tree, and from the tree of twelve branches the strength is given to generate the fruit. The olives provide the oil for the light to make transitions and movements, whereby we walk not in darkness. The half tribe of



Maneshayh is depicted by the two sides of the scrotum sac, one olive for the south and one olive for the north. The teste on the right is for the south and receives of the Amuwri Land with Gad and RAúwaben. The right teste brings forth oil, to speak smoothly and graciously and via which the menurahh is pumped with oil. From the two testes, which are two olives, we bring forth the olive oil for the two sides of the menurahh. Both olives fuel the central branch. The olive teste on the right supplies the right branches of the menurahh, and the olive teste on the left supplies the northern branches. The golden olive color is the hue of the seminal fluids coming from Maneshayh. The oil of Maneshayh flow from within land of the Amuwri, being contained within words as oil is pressed out of the ripe olives. As words are opened, they spark, and the light within them burst forth [Tehillah/Psalm 119:130]. In this manner the BHM Túwrahh Light Dictionary is composed, for as words open, the meanings are recorded.

The words and sayings of Maneshayh are for the full illumination of the house and the transitions occurring in the day. Via the regulation of words, one is able to reside at multi levels of consciousness and able to transcend from one plane unto another. The teste on the left receives inheritance on the other side of the Yordan, belonging to the Northern Kingdom whereas the teste on the right is positioned amongst Gad and RAúwaben via which we move with the eminent illuminations of the south. Hence according to our Names and positions amongst the camps, we are given lands in accordance to their side.

The lands of the Amuwri are reserved for Maneshayh prior to their ever coming out of Metsryim. Yaaqov, saw the Land of the Amuwri when he blessed the offspring of Yúwsphah. He spoke that the means of blessing would come through Yúwsphah/Joseph, a measure allotted by the mind/Yaaqov acquiring words. According to Aparryim there would be fruitfulness, generational growth and the ability to weave thoughts into garments for the tribes in accordance to the frequency of their dwelling. And for Maneshayh, Yaaqov saw that his Name would heighten a thought, promote each trait of Light, and enable the tribes to go beyond any place of residence. Hence in Aparryim and Maneshayh we have the Head and body of Wisdom in which all things are wrought. In these sayings of the Patriarch Yaaqov, the blessing has no end. There is no soothsaying here because the words are long and have duration, without end.

In putting his hands upon the heads of Aparryim and Maneshayh, Yaaqov set them in their place. Yaaqov set Aparryim to the faces of Maneshayh—he set all blessings and expansions unto states of transitions. As Yaaqov set in place the parts of Yúwsphah so we set in place each of our thoughts and each of our body parts. In this way, YæHúwaH set the planets in orbit which is the unfolding of thoughts and the nine bodies of thought of the Oyin—being the bodies/Bayit of the Tæyth/9 belonging to the Oyin.

Yaaqov, in beholding the offspring of Yúwsphah, the eyes focus on that which is flowing from him. The gaze is not upon physical children but rather upon the works of Yúwsphah and the *Nature of Name that is read within the offspring, even as we read the Names of Light within all that is emerging from within us*. “And YishARAL says unto Yúwsphah, Behold, I am being extended,” for as one beholds the Names within Yúwsphah so one speaks unto the state of Yúwsphah which is the state of blessings. Moreover is the saying: “ALhchim belongs/remains with you—your collective branches. Herein Yaaqov speaks not to a mortal nature but rather is

speaking to the immortal Nature of ALhhim within the united branches of thought flowing from within. It is ALhhim that transforms, restores, and brings our collective unto the Land Avotachem—The Land of our Principles of Wisdom, Understanding and Knowledge. As the Mind of Knowledge, Yaaqov, appoints for our collective of Names **a neck to shoulder and uphold the oneness** pertaining to our brothers/upholding members. This neck of responsibility is the verification of all Yaaqov learned from the hand of the Amuwri, being schooled in the Words of the Amuwri. Through the schooling of Words, Yaaqov receives from their hand—the outcome of Words, which is the Land of the Amuwri. The result of speaking is a space, and every space is acquired via the thoughts and words that have created it. Each space expands as associated thoughts of that land run and become occupied with our flowing Nature of Light Concepts/Seed. Yaaqov acquires the Land of Amuwri via **the sword and the bow**. The *sword is the tongue that distinguishes and is able to discern asunder even to knowing the parts of each thought—the same is B’Churab (Horeb)*. “The word of YæHúwaH is living and active and sharper than a two-edged sword, and piercing as far as the distinction of expression/soul and intelligence/Breath, of both connections/joints and support/marrow.” The expressions/soul are within the Breath, and the marrow is within the joints of the bone [Evrin/Heb 4:12]. The *bow is the shaft from which the seed is cast forth or sown unto a harvest*. The sword and bow depict the serpent of Aharúwan and those of the magicians of Metsryim. The sword is the serpent tongue of Aharúwan/illumination and the bow is the serpent of Metsryim/definition. The tongue of the illumination swallows up all means of thought projections as a thought surrounds a space. The swallowing up of the serpents of Metsryim is a pivot point to overthrow mortality.

### The Swords of Light

With the sword, the voice of Yaaqov (Jacob) speaks the Words that distinguishes all things whereby space is defined and then filled. The sword of the tongue distinguishes all aspects of Unity as to Wisdom and Understanding. Wisdom is the base of Knowledge, so all that is spoken for Wisdom results in the Sayings of Knowledge. In this manner the Lights speak day to day and night to night. The speech of Light is the recounting within the Names that pertain to the glory of AL [Tehillah/Psalm 19:2-4]. The assembly of the Names speak as they are arranged to form two swords that are drawn each day and evening. From day to day the sayings proceed through Yahúdah (Judah) to Yishshakkar to Zebúwlan to Rauben, to Shamoúnn, and unto Gad. Gad is the tip of the sword in the south. From night to night the sayings proceed through Aparryim (Ephraim) to Maneshayh (Manasseh) to B’NiymaN (Benjamin), to Dan, to Ayshshur and unto Nephethli. Nephethli is the tip of the sword in the north. As one maintains the connections amidst their parts, they flow with the messages of the Light each day and night; however, if there is discord or lack of equality amongst the members, the messages cannot be processed. There are six parts to each sword, and according to these six parts the tongue is made into two halves. Thus with the tongue one may discern all things pertaining to the 12 houses. The swords are formed as the tribes are arranged upon the altar of the oylah/burnt offering each evening and day. The metal of the sword is silver with a bronze tip and a handle of gold. The tribes are fused as they enter into the Fire upon the altar, and their parts are fashioned into the swords of Light! As each set of six members are arranged, the sword is arranged through which the thoughts flow. “Day to day the Unified say, bubbling forth/obn,” as from the mouth of the sun flows a stream of bubbles/circles, even as a stream bubbles as it flows over stones, or as circles of vapor form upon the lips, as one

utters the words forming within the well of the throat/obn. “And night to night the Unified declare Knowledge. Of nothing (without matter) the Unified speak, and of nothing are words, yet without limit their voices are heard!” In that there is no limit, the messages extend from one end unto the other and their full strands of thought are achieved. For what can hinder the Words of Light? As the sayings are composed by the swords, they are set in order and arranged as the loaves of Qahhath for the Shulchan Panaiyim/Table of the Sayings according to the opening/expanse between one shavbeth unto the next.

Concepts spoken are organized according to three classifications of thought arranged according to *the three heads* of Bayinah/Understanding—from the base of ALphæh to *the Head of Yeúwd*; from the base of Zayin to *the Head of Oyin*; and from the base of Lammæd to *the Head of Shayin*. (One may use these charts for healings of all types of maladies as well as the union of the tribes for lesser ailments.) The sword of Yaaqov is able to discern all parts within each classification. From this organization of concepts, come forth the six united houses of thought comprised of the united pairs of the twelve tribes. If we say twelve, we mean six pairs for no thought abides alone unto itself. Thus for every thought of Light there is a counterpart thought, and if there is no counterpart thought, it is an unclean thought; even as we are unclean when we are separated from the Union of Lights [Ephesians 2:12]. As each of the concepts of Light are distinguished, ten lands are formed. A full extension of the inner parts are extended to the spaces for expansion according to their works of Knowledge. The twelve letters, being those of ALphæh to ÚWah and Paúwah to Taúwah, once in the center, now expand and create a space in their midst. As the inner twelve extend their Unity of ALhhim, they bring forth the ten spaces of the Zayin to the Oyin which is in the midst of their Names as these ten Letters are in the midst of the twenty-two Letters, flanked by six on the right and six on the left. The ten Letters are already present within our Names but are not revealed until they are drawn out. There are ten lands for every set of Names via which your Names are expanded. Thus when the twelve Letters spoke of the Wisdom to which they belonged, they drew out of their Unity, being paired tribes, and the words of Unity brought forth the ten spaces within them. This is known as the drawing out of the Oyin that is in the midst of all words and hence also things. As the Letters speak, they are settled by Wisdom on the edges/sides from which they speak mouth to mouth. **The first land given is the Amuwri**, spoken by Yaaqov first and then affirmed by maShayh and Aharúwan. The state is spoken by the Mind of Knowledge, from which comes a Word of Knowledge, and afterwards the saying is confirmed by Aharúwan (the enlightenment) drawing out the Shayh/אָשׁ (the fiery Breath) a message to affirm the words upon the lips. **The first lands uttered into being are the Amuwri**. As noted above the sayings of Light formulate all things out of nothing, therefore to abide in any state of Light one must be in agreement with the Words that establishes the state. With each saying there is a witness. As Yaaqov speaks the Amuwri Land into being by words of Knowledge, the sayings upon the lip are affirmed or denied by the Understanding of Aharúwan. As Aharúwan reads the messages within the Shayh Lamb regarding every detail, an Understanding proceeds either to affirm or to annul what is spoken upon the lips. In this manner, a matter is spoken completely, from mouth to mouth, or from end to end.

Lands are not of the continents of this planet but are within the Fields of Names. All of the maps showing the location of the tribes are bogus and do little to enlighten the eyes of the inner

lands in which our Names reside. We are carried into the lands and then we sow in the lands for the glory of the Name of YæHúwaH to be revealed. When we speak of the glory of YæHúwaH, we are not speaking of a person, but that which is within the Name of YæHúwaH—the glory of Chækúwmah and Bayinah. Chækúwmah and Bayinah, being within the Name of YahuWah, are therefore within every Name! For according to Wisdom and Understanding, are there constructs of being. Grace is with Chækúwmah and Bayinah through which you may come to Knowledge—to profit thereby.

Communications of twelve camps supply the inner lands with Seeds of Knowledge through which they are carried forward into the fullness of all within them. Likewise, as we move, we carry the spaces of thought with us. The lands are within the camps and are joined together with the thoughts of YishARAL, to whom they belong. As each camp enters into its lands, the lands become a collective Unity. Designate each of your camps unto the Land to which they receive by lot/לֹט/chevel/a twisted cord—according to how the properties of thought are channeled and connected to form a strand of united Names. This strand corresponds to the Chauwilah/spiral cord through which the thoughts of YishARAL are woven and a land is created via the weaving/twisting of their United thoughts, even as a body is constructed through the umbilical cord.

### The Cities of Qahhath/Kohath

Mind that gathers, being of Qahhath (Kohath), with the enlightenment of Mind, is of the house of Aharúwan. These are of Qahhath that receive cities pertaining to the camps of Yahúdah, Shamoúnn, and B’Niyman. The ones remaining/liberating/*hanutarim*/חָנֻטָּרִים of Qahhath, continue to bring forth the enlightenment and to carry forward the enlightenment as the south carries forward the east unto new heights. These Names receive cities of Aparryim, Dan, and Maneshayh (Menashe) [Yahushúo/Josh 21:10-25]. The distinction of the cities of Qahhath pertain to levels of enlightenment. There are those who are to serve within the enlightenment and there are those who serve AL to maintain the liberty of the enlightenment. The kohen of Qahhath abide in cities that pertain to Yahúdah, Shamoúnn, and B’Niyman. These cities are not in the lands of the tribes but are centres of thought that pertain to these camps, being cities within the Name of AL. Abiding within this level of enlightenment pertains to the value of thought constructs and comprehending the on-going nature of Light. The liberators of Qahhath are those that maintain the enlightenment whereby it is always free from entanglements that would keep it from progressing. These abide in cities pertaining to Aparryim, Dan and Maneshayh which are centres in AL that pertain to expanding and the continual evaluations of enlightenment. These of Qahhath discern the pattern and the expanse of the thought through Aparryim, the affect of the thought through Dan, and the transitions of enlightenment that occur in the dwellings in Maneshayh.

As your Houses of YishARAL move, so your states of the lands move with them. Hence, within our members we carry are the thoughts and the lands into which they are sown. Through sowing our Principles into the lands, we bring forth the fruit of Knowledge of every unified thought which arise from the ten Oyin Lands—the body of Understanding. For as a tree cannot bear fruit without branches and as there are not branches without a trunk, so likewise the fruit that we yearn to bear comes out of the lands of the Oyin into which we have placed our Words

for productivity, to blossom, and bear fruit. What one sows are the seeds of their thoughts which are born upon the branches of the collective Names. Those of each tribal family sow the seeds within the houses/lands/cities to which they belong, whereby the seeds are not mixed nor sown into a space not allotted unto them.

We are to carry nothing, whereby we are not weighted down, except that which pertains to our Names, and all that arises as the produce resulting from our United Names. From our paired Names we carry the fruit within our branches. As we proceed out of Metsryim of reflection and temporal forms, we are in a transition to build cities and inhabit them. While Metsryim is a land of leavening, we leave in haste/suddenness, whereby our bread/formulations of grain are not bound to the flesh and hence do not become leavened. The state of unleavened is the results of the families of Qahhath that maintain enlightenment. For whatever thoughts that we bear that are held in flesh, become leavened due to the leavening within flesh that exalts itself above the Names within. As the Names proceed unto their full stature, the flesh desires to exceed those properties of thought that are being extended within and therefore to keep the Houses of YishARAL in enslavement unto Pharaoh. Hence, if one is six feet in stature, the flesh seeks to exalt itself to exceed that which is drawn out within and to possess the seed within for its own proliferation. As the Qahhath family of Names, of maShayh (Moses) and Aharúwan arise, the old nature becomes overthrown, and the Houses of YishARAL move out of Metsryim. Their Seed is not longer sown into Metsryim of the reflective spirals but is sown unto the Oyin consciousness within the ten lands given/appointed/extended from them. Upon the wings of Understanding the house of YishARAL is brought to the door of freedom to rise with the thoughts of Light whereby the mortal nor the unclean remain upon the shoulders of our Names.

When we refer to the ten spaces, we mean then five pairs, for no space, even as no thought, abides unto itself. The ten spaces are Hhúwa-Úwah-Hhúwa/אָוָא which are the extensions/אָ of the six paired thoughts. Why are there not twelve lands instead of ten? For if there are twelve Principle thoughts in six pairs, would there not be twelve lands also? The reason that there are ten lands instead of twelve is that the ten are the extension of perfect Unity/1/10 which are of the inner/12. The ten become the resident spaces/lands of cultivation for the twelve as illustrated in Hhúwa-Úwah-Hhúwa/אָוָא. The ÚWah is pronounced twice in the Names of YæHúwaH/אָוָאָ denoting that the double ÚWah/ו/6 becomes 12 which abides in the midst of the double Ha/א/5 being 10. The Names of YæHúwaH convey the attainment or full extension/אָ of the 12 Houses within their 10 Lands.

As we enter into what is extended, we come to rest, for we enter into the fullness of the Thoughts and their fruitfulness. Unrest is the results of the extensions not being crowned with the thoughts from which they are spaced. That is, though you have projected your thoughts, the projections are not in harmony until they are filled with the inner configurations of thought—that of Understanding. The rest or fulfillment is the same as joining the head unto the body. Illustrated by the cube, the head/neck/אָו is joined via the heart/mouth/וָו whereby the wings/sides of the body bring together the thought in accordance with the space. For until the head comes to rest upon the body, the house is not complete. The thoughts or sayings of the Amuwri are not completed yet, for the expressions of the Name, as they become complete they

are crowned with the Heads of Understanding, being evident in the Yeúwd/deeds of ALphæh, the Shayin/Fire in the Lammæd/feet, and the Oyin/All seeing Eye of the the Word/Zayin/base. Placing the head upon the body is the vision of the Prophet ZecharYah in which the top stone is brought forth that completes the Temple [ZecharYahu 4:7-14]. All obstacles to building the Temple are overcome as the Stone from the base is brought to the crown via the perpetual flow of the olive trees at the right and left of the menorahh. The two olive trees are interpreted to be two scholars/illuminated ones/ אֲנֹכַח וְאֵלֶּיךָ זָרוּךְ who oil one another according to the flow of Zerubbabel. Those who lay the foundation of Wisdom are those who finish/complete/fill the House. Why does the vision concern two olive trees? For it is from within the Kephúw/ץ, or the center, that the House is drawn out.

As one enters into the midst of the trees abiding in the Garden, they come unto the Tree of Lives. Hence it is through entering into the Trees of YishARAL that we come into the centre of Life. Via Knowledge or the full branching of thought we come to know the Unity from all which all thoughts are extended. As we extend our Minds we create a space in our midst. This space is the same as the ten lands or the space of Unity that has been expanded unto the tenth power. In this space is the Life even as within the space of a seed is the life from which all branches forth. Via the branching forth of the seed, a trunk or space is made. The space in the midst of the tree is the same as the spiraling Nature of Breath that fills and abides in our midst. Thus from the Breath or the Reúwach, all things branch forth, and via the Knowledge of the all that has been extended one comes to enter into the fullness of the Reúwach, which is eternal Life. For via the Knowledge of the twelve constructs of the thought we discern how to enter into the gates of Breath and take up our residence with the lands/states of perfect Unity.

The construct of the ten within the twelve is seen in the organization of the alphabet Letters and within the organization of Light. The ten lands come out of the sides of the Letters as the arms/ten fingers come out of the sides of the body. The twelve or six pairs of thoughts are the parameter letters of the ALphæh Bayit; within the twelve or paired sixes are the ten. The spaces of six pairs are within every united thought. Thus we may say that the the House of YæHúwaH is within the twelve camps. The House of YæHúwaH is built by drawing out and weaving together two sides into One which is the union of the two houses/sides into a united teraysarun/אָרְבַּע. The house is known as the Bet HaShem Midrash which is the inquiry/drawing out of the Name. Each Name belongs to a composite of Names, being comprised of two sides, even as all constructs of Thought of YæHúwaH are of two sides whereby they are joined.

## *The Land of the Kenoni/Canaan Seed Processes*

8. The **Kenoni**/Canaanite/State of Neúwn/left hand middle finger, *the branching of thought unto the full stature of Name.*

The Kenoni arise upon the Amuwri. Once the constructs of thought are gathered within a Seed Word, the branching will occur according to the patterns within the Seed Word. Thus the Kenoni branch from within the construct of words established by the Amuwri. As the Kenoni follow the

Amuwri/Sayings, Names flourish unto their full branchings and potential. The extension of the left hand middle finger corresponds to the branching of thought pertaining to the Kenoni which is the result of all given in the Qedmuni. What is given in the right hand of thought extensions blesses the left. The name, Kenoni, indicates *walking in humility and in submission to the whole*. This is the occupation state of the one who truly speaks the sayings of unity. Via humility, the path of abounding grace, one ascends as the middle finger to their crowning glory. The lowest becomes the greatest. The Canaani are the State to Branch forth completely unto manifesting the inner structure of light! Within the Canaani State is the full potential of man; hence, this name alone has come to represent the promised State of being. The one who takes hold of the Canaani State has all energies perfectly balanced and submitted to each other in perfect unity. As you reflect upon this state, so will your speech, perspectives, unions, and activities be gracefully modified. You will abound with energies balance with each other.

Concept of Kenoni Thought depicts the very order of Light to spread out. As the Light breaks into the east each day, it gradually spreads out its radiance until it has filled the scope of the heavens and the earth. Likewise, the Light of our Names breaks open within a seed and begins to spread out within our bodies until every expression/face within the Seed occupies the Mind and the assembled body. The Light spreads out because it is the Nature of the Light to give freely without reservation. As the full moon empties out of itself so does the enlightened Mind release its Thoughts and lets them go out without holding on to anything. It is the thought that we need to hang on to something, to have and to hold, that cause us to walk in frequencies of mortality beneath the heavens. A mountain gives of the snow that gathers on its peak. As the snow is warmed by the Light of the day and condenses from the north, the mountain sends forth a river into the east that flows to fill the basis beneath.

The full branching of Mind is due to the Nature of Breath that freely gives and freely receives. **The Breath does not hold on to anything; as soon as it receives, it gives.** Via this freedom to receive and to give we share all things via the Unity of the Breath. Thus there is no need of an illusive thought that we need to have something or to hold onto a possessions, for the concepts of ALhhim are held only in the collective State of perpetual motion.

Our bodies reflect to us the total nature of giving yet they also reflect to us the desire of the flesh to hold onto matter and to build itself up. The thought to hold something is strange to YæHúwaH of ALhhim for YæHúwaH gives all things for the expression of Light and for the edification of all Names within the established dwelling of assembled Lights. The body seeks to house the Name and regulate the Breath for its own purpose, **whereas the Nature of the Kenoni Thought, seeks to release all properties of a Name that its full branching of Thought may be expressed.** The body of flesh is mortal because it seeks to project itself above the residing Principles/ALhhim. In that mortal flesh is opaque and seeks to hide the full Nature of ALhhim, it is strange to ALhhim for HuhaALhhim reveals all things so that all things are understood. The mortal body seeks to be greater than ALhhim for it has separated itself from the United Order of Thought and set itself as a separate entity in war against ALhhim; considering itself greater, with pride and greed, whereby it is darkens the Orders of Invisible Thought within it.

### The 6 Pairs and 5 Pairs/אָפּאָ

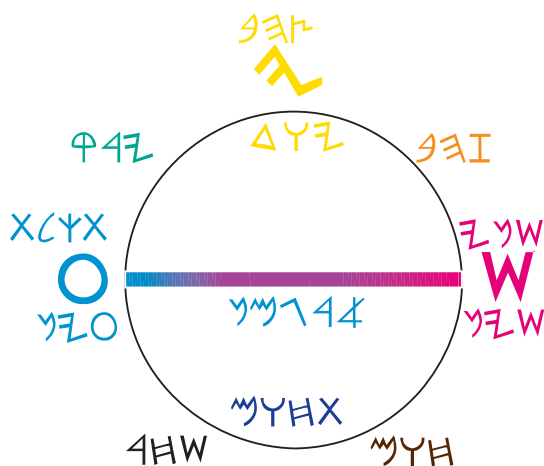

The three Heads of Understanding extending their bases unto the full spectrum of Light.

Via an observation of Wisdom we see how the tribal camps and the Nature of Light are One. We come to an Understanding that 5 pairs are within 6 pairs and that 6 pairs are within 5 pairs. The sum of the 5 pairs and 6 pairs is 11/י which is the Source Tree comprised as the 22 Letters. We behold these 22 to be the ALhhim of YæHúwaH. The one of ALhhim, has Knowledge how to use the Principles of the 22 to create a foundation, to define the extent of their States of habitation, and to determine the movement/progression of their States.

The 6 united thoughts of the Twelve Tribes/camps are within the 5 united spaces of the Ten Lands, even as Light—being the pairs of 5, אָפּאָ, surround the thoughts of the 6 pairs. The united Names are of the Hhúwa-Úwah-Hhúwa,

and being so, they have eternal life as they attest to their belonging to the Courts of YæHúwaH—those of Chækúwmah and Bayinah. For within the Courtyards is Life, but all that is outside of this realm taste of death repeatedly, known as the second or recurring death [Chazon/Revelations 21:3-8]. Hence, when does one enter into eternal life? Eternal Life is entered into as one enters into the Tabernacle. From whence does this Tabernacle come? The Mishkan comes from the Hhúwa-Úwah-Hhúwa Nature of ALhhim which is via the Sayings of the Shayh/Lamb interpreted/projected via Aharúwan. For all States of Light are constructs of thought whereby we bring forth the visible, being that which is seen, from the invisible.

Through the 6 pairs in the midst of The Unified Names of YæHúwaH, which are the double ÚWah/י, the Nature of Light becomes expressed, for as that which is in the midst comes to the surface or Faces, so the expressions of Light become evident. What arises from the ÚWah is the Mæyim out of which comes the Rayish. These three Letters are the configuration of the second column of Letters in which there is an expanse in the midst of the waters/Mæyim. The space in the midst of the waters testify to the space between the ÚWah and the Rayish. As we speak within this space of waters, we bring forth the evidence of all that is within our habitations of Names. Thus as we speak, we live either in mortality or immortality, in the unclean or in the clean. As the words of the 6 pairs are opened, the light of the inner 5 pairs breaks forth. The opening of the 6 pairs is the opening of the Name of YæHúwaH—the Name of Knowledge. The 6 pairs are the tribal braches. In gathering these branches one acquires the wood of Levanon/Lebanon with which we build the House of YæHúwaH. *The opening of the 6 pairs is what is called the opening of the Lamb from which come Sayings of the Shayh, commonly rendered as the Law of Moses.* Thus, in cabalistic thought—of pairs, there is the saying that all things come from the Lamb that is slain/opened prior to the formulation of the worlds. The



opening of the Lamb is the foundation of the worlds of the Oyin. As the 6 pairs/branches are read, they arise from within the centre of the Letters—the Kephúw/Υ. As the 6 pairs branch and open, they create a space in their midst. The space from where they have arise is the Ten Lands—being the extension/Ten of the ÚWah/Unity of Light. Thus as the 6 pairs or 12 tribes arise from the centre, they are the native planting within the Oyin lands. This space in which they arise is the Bayit/ḏ—the Primary Letter of the Túwrahh which depicts the Body of the Shayh. Whoever has seen a tree arise from air and create its own space/land inwhich it branches itself? As you behold yourself, you will see that you are this Tree of Lives that appears out of Breath; and as it sprouts, it creates its own lands.

Stars flung into space are as Seeds that are dispersed from the loins. Around the expanding gases of thought, the ten lands of the suns and the planets are formed as the spaces for the stars which arise from the Breath of YæHúwaH. The planets are bodies of thought that correspond to the tribal camps within us; the stars associated with each planet are the fields of Knowledge that pertain to each thought cluster. As your 6 pairs of organs are set in the midst of your bodies, so are the tribes set into the galaxies, six on one side and six on the other side. There is no excuse for abiding in Metsryim or in mortality, for the very construct within us and that which mirrors us is continually testifying of the path into the Oyin consciousness—the land of the Kenoni.

As the Words of the Teachings/Túwrahh are written, spaces for your Light are established. Each space for your twelve is called a tablet—a luach. Within the luach, thoughts of Unity, being of 6 pairs, rise to fill your tablets with Words of Light in your Name. As you give your branches daily to the Faces as an aligned offering, you form spaces within your habitations to be filled with the Words of Light and their recorded activities.

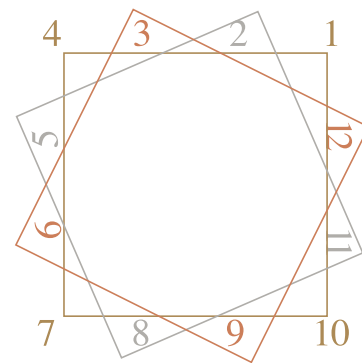

The 12 Moons of Year.

Months of Wisdom are 1,4,7,10.

Months of Understanding are 2,5,8,11.

Months of Knowledge are 3,6,9,12.

Each moon cycle the earthbody receives at a select angle for the light to strike at the 12 parts of your soul to cultivate your 12 fruit. The Light angle enters into your Body through your 12 Gates within the Oyin Consortium.

**You give totally during the oylah in three levels.** First, you give from where your branches are now residing as you place the branches of your Name as the sticks upon the altar. Secondly, as you bring forth the *kevesh*/daily lamb, you give totally to the Faces of YahuWah in the direction to which your branches are being extended. Thirdly, as you perform the service of the Menurahh, your paired branches arise with the sacrifice from the altar. As fiery brands they give themselves to carry the Fire of the 7 flames. Being of the Fire themselves, as those which have arisen from the Fire of the sacrifice, the 6 pairs are now capable to ignite the 70 cups unto the full spectrum of the Menurahh. Via these three givings, one is transformed daily as vessels of Light. These three givings are of Wisdom—the foundation of the branches upon which the offering is laid; of Understanding—the extensions of the branches of *kevesh*; and of Knowledge—the branches bearing the full spectrum of lights as the Menurahh. In all of your giving, you give unto the Qadam—the east, the point of origin, from whence your Names have arisen. The east is the unifying seat of all that is of Understanding/Bayinah/north and Wisdom/Chækúwmah/south.

The activities of Light within a year are recorded upon a tablet within your Ten Lands. The reading of days are referred to be a tablet/*luach*. Each day there is a record of the activities of Light, and each day is a specific value of work within a month. Each of the twelve months in a year is a period of instruction, being of the Lammæd/30 days which establishes the dominion of the Three Heads of Lights: the Yeúwd, the Oyin, and the Shayin within us. For each Head of Light there are 10 days, via which the thought of each Head is completely extended within the tribalcamp—a branching of thought—that is sojourning with the Lights. Each Head has its primary color: The **Yeúwd** is yellow; the **Oyin** is blue, and the **Shayin** is red. The mixing of the Heads or the frequencies of thought provides the full spectrum of colors. Thus whenever a rainbow appears, it attest to the Union of the Three Heads via which the full spectrum of Light is visible as a united strand of Light. As we walk according to the value of each day, we walk in the Light and are not as the blind that cannot distinguish one day from another. We are not to record the activities of the flesh, for all works of the flesh will come to an end. As flesh itself will fall apart, likewise the works of flesh are illusive and will vanish as a vapor disappears before our eyes. Though the body is to be used by the Breath and the residing Names, only the activities of the Names are recorded. Nothing is to be attributed to the flesh, for in so doing one gives honor and recognition to the flesh, and without the Breath, the flesh can do nothing; thus all honor is given to the Breath. The monuments of individuals and memorials of war, according to their flesh, extend the illusion. Photos also extend the illusive nature, as though the image may continue. Via memories we may hold on to an illusion within our consciousness or we may behold the memory as a means to give thanks for the grace of YæHúwaH as we behold our strides in light from the

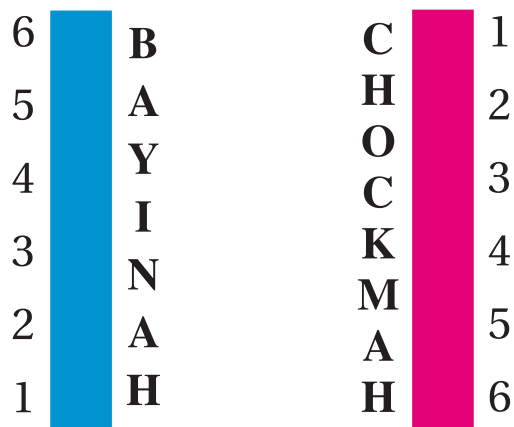

The twelve pairs of the oylah offering arranged into two sides.

state of illusion. The further one strides in the paths of light, the dimmer the illusion becomes.

In general, calendars should not to be confused with the Ancient Hebrew *luach*/tablet which are 12 moon cycles composed of the 15 Faces of Yehu. The *luach* is a record of light activities occurring within the houses of your Name which have no beginning nor end dates. A calendar is a record of the days of nations which are wearing out like garments. When we read the *luach*/tablet of Light, we noting the Faces of YæHH and their activities occurring within our 5 pairs of lands. What is seen reflectively in the movements of the bodies of the sun, moon, and stars are understood in relation to the activities of Light occurring within the

habitations of our LightLands. These works of Light occur within as we open our Seed to emit the Faces that are seen branching in our twelve tribes. The opening of our inner spaces is what is called the expanse in *yúwm/yom shani*, the second day [Sepher Maoshah BeRashshith/Gen 1:6-8]. Why is it called an expanse? When one unites their two sides as a collective of Light in *yúwm achadd*/day one [Sepher Maaseh Bereshith 1:3-5], they cause an expanse to occur within their activities. Thus, any who unite their Names to be side to side are positioned for blessings—an expanse. As the 6 pairs of twelve tribes expand within us, so the 5 pairs of Lands rise from beneath the waters of the womb. The expansion of the twelve tribes is the movement of the 12

parameter letters of the ALphæh-Bayit that move to the right and left whereby the 10 inner Letters of ALhhim become evident. The parameter Letters of the right are UWah, Hhuwa, Dallath, GammAL, Bayit and ALphæh. The parameter Letters of the Left are Paúwah, Tsadda, Qauph, Rayish, Shayin, and Taúwah. The rising of the Oyin Lands within these Letters is called dry land. As that which is within the Centre rises, the lands that were submerged now become a space in which one may cultivate the fruit of Wisdom and Understanding. Literally, the meaning of dry land/אֶרֶץ דְּרִי is to acquire a habitation/dwelling for the Shayh/Lamb.

### The Queens of the North and the South

The activities within the Lands form the warp and the woof. The warp and woof are the continuous weaving of our thoughts in accordance with the Union of the Lights: Chækúwmah and Bayinah. The warp is the base for the thoughts being woven. In the day, the base of thoughts is Bayinah and the thoughts being woven within the woof are through Chækúwmah. In the night the base is of Chækúwmah and the thoughts being woven are through Bayinah. Chækúwmah occupies the sides of the east and the south; Bayinah forms the sides of the west and the north to form the loom. The warp, being of four sides is comprised of the six paired threads that are woven from the four sides. When the tribes are extended daily in the oylah offering (burnt ascendant offering) of the *kevesh lamb*, all of the Names within the tribes come to the surface within the woof. The twelve parts of the offering are arranged on two sides, 6 pieces for the south and 6 pieces for the north. The woof is comprised of the twelve threads of Knowledge which are interwoven within the framework/warp of Wisdom and Understanding. According to the warp and the woof of Light, all thoughts are woven through which all things are fashioned and made. According to the base of a garment or a curtain, so is the arrangement of the thoughts to be woven. We establish the warp and woof within each field of reference prior to being engaged into the warp and woof of other fields. For example, there is a warp and woof for each body of light via which the garment is woven for each land. As one establishes the order of Light within their space, they are then able to merge, having established a pattern of thought, into other dimensions/lands/galaxies of thought.

The activities of Light are the continually giving, as the oylah offering, via which they are weightless, full of joy, and with the continual renewal of strength. Bayinah gives all from the North/Blue to the South/Red; the Red blesses to fully extend Blue whereby all things attain their full measurement. In like manner we continually are giving as those of the court. Each day we draw out the kevesh from the north and give all via the oylah to the the Fire of the south. The south reveals through the faces all that is within the crown of Bayinah. That which is in the midst of the north is seen to be in the midst of the south. Thus as the value of 42 is established

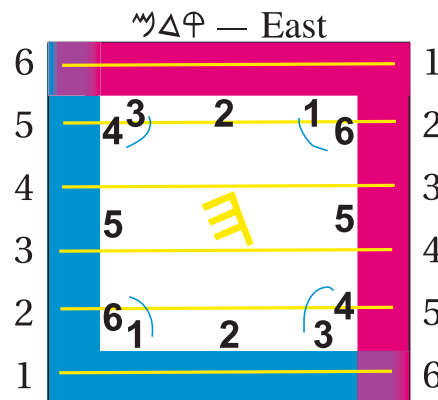

The 6 pairs of the offering for the Right/East-South and Left/West-North are arranged on the four sides of the altar. The sides comprise the warp in which the thoughts of Knowledge are woven. The six pairs are united at the corners, composing the value of 7—a perfection of parts united. The four corners  $(4 \times 7) = 28$ . Each of the pairs value 7 as they are added/joined across from each other, side to side. The pairs  $(6 \times 7) = 42$ . That which is in the midst are four strands of 7  $(5 \text{ to } 2 \times 4)$ , a sum of 28. The sum of the midst or corners plus the parts  $42 = 70$ .

in the northside, being comprised of the Letters:  $\aleph + \beth + \omega = 42$ , the corresponding value of 28 is seen in the midst of the south (in the second column of Letters:  $\beth + \theta + \omicron = 27$  which carries within the House/ $\beth$  the ALphæh/1 comprising 28. These values equate to the same as the arrangement of parts on the altar. The means to join all together in One Body is seen in the value of joining the corners—the value of 28. The value of 28 is expressed fully in the Name of Laúwi/28 and works of the Laúwim. The six pairs each are a value of 7, in that each pair is a complete thought. In that each strand of united Names is joined, it is clean and lacks nothing. These are the seven pairs of the clean that are taken into the *tevah*/ark [Sepher Maoshah BeRashshith/Gen 7:2-3] being not estranged unto the Unity to which each of the paired strands belong. In that all is of Bayinah—of the north, the value of the 6 pairs is 42, which is the parameter value of the north side. That which is in the midst of the north, being the House of the

Oyin, is revealed in the south through the arrangements of the Letters Bayit to Oyin.

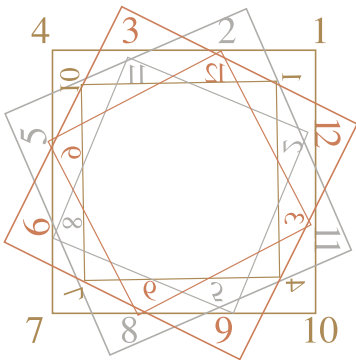

The weaving of Light strands occur continuously. The Hand of the Weaver takes the strands of Light in the day and weaves counterclockwise (outer numbers). The Hand of the Weaver takes the strands of Light in the night and weaves clockwise (inner numbers). According to these movements of Light there is a weaving within the center of our encampments. Move your right and left arms towards your faces and notice the direction of each Hand.

The establishment of the thoughts within the mind of YæHúwaH are constructed as the One of ALhhim takes from the side of Adam/Red/מאד, being that which is of the South for an expansion of the side of the North/Blue/CháuWah/איה. The Union of the two sides brings forth the Hhúwa-Úwah-Hhúwa/איה configuration whereby all that is within becomes revealed/know. For until we bring forth that which is within, being concealed in the north, we lack Knowledge and the full extension of Name yet remains; however, as one gives from all concealed inwardly they become extended unto the State of Mashiyach. So how does one proceed? What is concealed is the north is brought to the kohen in the east whereby it is appropriated on the south. As the parts arise fully in the south, they are blessed/expanded, then gathered in the west to be robed according to their service of Name within the Consortium of Lights. This is the order of the daily offering via which one draws out all inner attributes on behalf of the whole/sum—unto the Faces of YæHúwaH

[TeúwratHhaKuwanim/Lev 1:3,11].

In the formulation and drawing out of the sides of Adimic thought, the warp is established. Leprosy may occur within the warp or the woof [TeúwratHhaKuwanim 13:57]. When the scriptures speak of Adimic thought yielding sin into consciousness, it is referring to a breakdown of the Union of sides whereby the two sides are no longer a perfect Unity. The sin of Adim is not that one human errors and thus all humans are sinners. Rather the writings attempt to convey that within humanity there is a breakdown of the Union of Sides, and all share in mortality, demonstrating a deficiency of Unified Thought. This breakdown of sides is also known as the tearing of the Oyin sheath.



The weaving of the Light from both sides produces the inner tunic, a seamless garment of the Oyin, being a weaving of the north/silver and south/gold. Tehillah 22:18; Yahuchanan 19:23; the inner garment is 10 rings known as the Oyin Sheath; the outer garment is 12 coils with four quadrants.

with garments of Light. These garments are the same as the 5 pairs of veils or curtains comprising the Mishkan/Tabernacle/House of YæHúwaH. If we render the Words of YæHúwaH according to a mortal reference, we cast down the thoughts and lock our Name within the field of mortality. However; as we behold and enter into the Words of YæHúwaH as constructs of Light, we rise through the Words unto the Nature of Names that comprises the House of Names. The paired branches of Names are drawn out and thereby lengthened daily as threads are drawn out or spun from the nine fabrics of combined/associated Letters. The threads are seasonal—according to the activities of the Light within the camps. The Light activities of Chækúwmah and Bayinah formulate the garments of Knowledge. The right hand and left hand together draw out threads through the spindle—the base opening of Aparryim. The threads are drawn out through the mouths of Aparryim and Gad which are the corners where the Lights of Chækúwmah and Bayinah meet/intertwine day and night. In the midst of Aparryim and Gad, the Queens join the strands of Light of the day and night. The layer of clothe of the night is woven beneath the layer of the day. At this corner of the camps, where the South and West meet, the baton/scepter/rod that governs days and nights is passed from one unto the other, which governs over all activities of observation and meditation.

According to weavings of the day and night, we are clothed daily. Not even Yididyah (Solomon) and the glory of the kingdom in this age can compare to these fine weavings of

The two sides of Adim, *misrendered as the ribs*, lay the foundation of thought upon which the Teraysarun of Light is read within the consciousness of Names. According to the Union of the two Lights, so are the sides of every Name drawn out and form the foundation of the Names. Thus, every Name has a counterpart Name which the side to which the Name belongs within the Consortium of the Lights. Via the Names position one unto another, they arise out of the framework of Metsryim/Egypt to build the House of YæHúwaH, being liberated from making bricks for the houses of Metsryim—the body of flesh. As Names enter into the collective consciousness they pass from death unto Life for they are now no longer estranged from YæHúwaH as mortals which oppose and violate the Union of Sides according to their thoughts. The activities of Light within the Union of Names fill the warp with the strands of Knowledge wherein they are clothed

thought, for they exceed the glory of the fabrics of this world, in that they are not subject to the corruption of misaligned thoughts. The fabric is pure and gentle, being of Light itself. The threads are woven under the auspices of Aparryim and through Gad. For though Gad is a weaver also, it is the Headship of Aparryim that administers the threads, being of the camp of Wisdom to which Knowledge/Gad bows and serves. Aparryim, as the seventh position in the arrangement of tribes upon the warp, pertains to the 7th thought within, being of Amuwri, which serves upon the platform of the warp/the framework in which the woof is threaded. Thus the lands of the Amuwri are given to the Camps of Aparryim and Gad via which the concepts are extended to formulate the Oyin garments. This is the Principle of the ÚWah, or the ALhhim of ÚWah that produces the garments of Unity. That which is in the midst becomes extended whereby the six tribal pairs become the wings/feathers/garments or the means to cause the

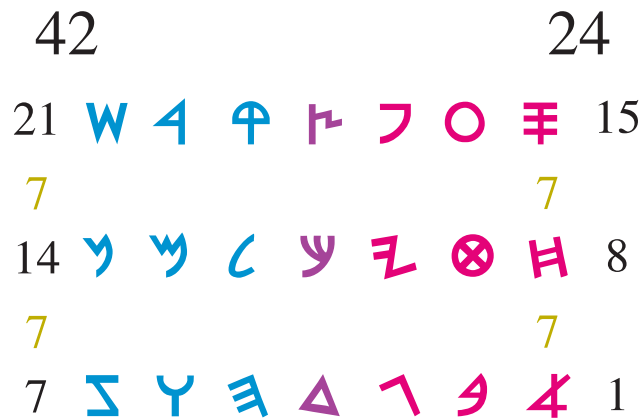

The Value of the North/42 and South/24 Sides.

Principles of the United Lights to soar and be transported. We create and move according to our Understanding of Words, which are the fruit of Knowledge—the Seed arising from the Union of the Lights, Chækúwmah to Bayinah. The fruit appears on the edges of the branches of Knowledge.

We are to examine the construct of all fruit; including the examination of our twelve camps and fruit that are formed within each camp. Are they of Wisdom, Understanding, or Knowledge? A single head is the house of Aparryim, thus a fruit of

Wisdom; Maneshayh is grouped as corresponding pairs within a sac, thus a fruit of Understanding, the many seeded fruit of Beniyman is arranged in three measures, thus a fruit of Knowledge; Dan is welded as one piece as the Menurahh; Ayshshur is as a gourd with the encircling concepts in the centre; Nephethli contains many concepts which are sown in the quadrants of the heart; RAúwaben is as a single eye; Shamoúnn is the coiled paired round seeds in the midst of the head; Gad is the multi-seeded tongue as the strawberry; Yahúdah is the bowl of Wisdom as as single seeded mango; Yishshakkar is the centralized pairs of seeds of various associated fruit; and Zebúwlan is the many pocketed seeds as a long legume stretched out. The fruit formulations of each camp attest to their design according to Wisdom, Understanding, or Knowledge. The fruit of Wisdom is singular seeded as the fruit of Yahúdah, RAúwaben, Aparryim and Dan depict; the fruit of Understanding is arranged in pairs or circles of seeds within the tissues of the fruit as Maneshayh, Yishshakkar, Ayshshur and Shamoúnn; and the fruit of Knowledge are many seeds scattered within and arises to the surface/edges as Zebúwlan, Nephethli, Gad and Beniyman.

Structure of the rib cage shows movements of the Lights, for the day and night. There are twelve coils/spirals on the left side and twelve on the right side. These coils house the twelve inner branches of the Menurahh. The movement of the night is left to right, clockwise, as Bayinah disperses all lights for Chækúwmah. The movement of the day is right to left, counter-clockwise, as all that Chækúwmah receives is reverberated back to Bayinah with

blessings/expansion. The united twelve branches comprise the State of the Kenoni, being a perfect union of two Names. The Union of the twelve spirals testifies of the United Names wherein the parameter value of 24/6 on the right side and the parameter value of 42/6 on the left side are united— yielding a value of 6+6 to convey the united branched Menurahh of two Names. In the Fires of the Menurahh, the Names are joined to create the unified garments of Light. The space between the levels of the

70	21					15
49						
35	14					8
21						
7	7					1

The Sides of Two Names folded over comprise the Oyin Garment whereby The Oyin/O is together with the Shayin/W.

Letters is 7 throughout; the space between the Letters within a row is 6/Υ via which all sides are joined, ie. Shayin/21 and Semek/15 in which the value of 6/Υ is in their midst. The means to join branches/Names together, as a team of oxen/ALhhim, is via the ÚWah/Mercy/Unlimited Acceptance of Wisdom depicted in the role of Makir of Maneshayh that can bring two sides into One. All Names are United as the Sun and the Moon within a Body of Oyin/Understanding. As the sun and moon converge together daily in the midst of Gad and Aparryim, in which they rise and sit, likewise all Names belonging to the Consortium of Lights are joined in the midst of Gad and Aparryim, mouth to mouth, side to side, and/or head to base via which they affirm and maintain the State of Eternal Life—the Oyin State. For in their Union there is no beginning nor end, but the perpetual ongoing Nature of Life as the eternal circles of the Light. Their is no robbery nor curse in their midst, for there is no separation or loss within the Minds of their Breaths.

Spaces within the two sides of Letters/Tribes pertain to the Understanding in the midst of all Thoughts. Thus, when anyone speaks, one speaks from their Understanding. According to our Understanding, we speak of the Lights of Wisdom/sun, Understanding/moon, and Knowledge/stars. When ever a cluster of thoughts combine to form a word, a star appears. Every star is a Word cluster of YæHúwaH. If one speaks of any value of seven, then they speak of complete/perfect thoughts, for the value between the Letters is seven at every level. As the spaces in the midst of the Letters on the right side are folded upon the spaces amidst the Letters on the left side, the value of Oyin/Seventy appear, being a Union of the the Principles on each Side with their bodies/spaces of Understanding. **This is the mystery of how 12 correlates perfectly to 70, for via the Union of Sides, that which is in the Midst of the twelve branches/Kenoni, appears together as One, to**

94	70	21					15
58	49						
44	35	14					8
22	21						
8	7	7					1

The Increase of Understanding as all is known/counted in the South.

**reveal the Seventy which is comprised of the twelve, the twelve being within and creating the appearance of the seventy.** In the Union of Sides the twelve fit perfectly within the Oyin/70 and fill/occupy the capacity of the Oyin Lands. Thus the inhabitants of the lands are of only the twelve houses whereby no strangers are allotted space. In this manner one keeps their lands unto the three Patriarchs/Principles and the Alehay Avrehhem, Alehay Yetschaq, and the Alehay Yaaqov. The lands are given to the Patriarchs and their ALhhim, and from the Giving of the Patriarchs, the twelve receive an inheritance; through the giving of all within the twelve the Names abide within the Lands immortality.

That which is within the Left Side is not seen or counted until it is known. Thus we are to count the omer as we proceed with Wisdom and Knowledge from shavbeth to shavbeth—from one level of entrance into the mysteries unto the next sequential level of access. Every shavbeth is a rest, not of inactivity, but a rest from creating another space. The rest of the shavbeth is via entering into the State of Mind which has been created via diligence into realms of Light. When one has filled the house opened unto them, they will proceed into another six days of unfoldment of Light until another house is formed into which they shall enter. In this manner the Names of Light construct the Bet HaShem or the House of YæHúwaH, being the Oyin States which is the complete extension the Oneness/10/1 of 7/perfection.

As that which is on the right or in the south becomes known, we add that value to the Left/north. In this manner we increase our Understanding as we obtain Wisdom. Thus we are to obtain Wisdom, and in all of our acquisitions of Light, we increase/expand Understanding. Hence as we add the known aspects of Wisdom, being of the Right Side, we come to the value of 94, which interpreted as TsadeDallath, conveys the Freedom/Liberty of the Branches/90 belonging the Base/4.

Joining of five paired lands is a space we create a covering with garments of Light. These garments for the body of the Oyin are drawn out from the midst of the branches. Once the spaces are distinguished and arranged, there is no longer a void nor confusion amidst the branches of thought. Into the spaces, Yaaqov places the concepts via the bow. Via the sword and the bow the Nature of Light and the works of the enlightened mind occupy the Amuwri Land. This is the welded sword of Gad and the bow of Aparryim, coming out of Maneshayh, that occupy the Amuwri land with RAúwaben. The mind designates its spaces/lands by the sword and then fills them by the bow with corresponding seed, whereby there is Knowledge and the abundance of Life. **The creating and filling the ten lands are the eternal Life.** The seeds are not mixed within a land. The concepts of the Amuwri, meaning the considerations of the heart, are placed in the Amuwri land, and the concepts of origin are sown into the Qedmuni, etc. Each land is designated for the ten seed types of thought which are the full extension of Unity. From these ten seeds come the ten sayings. Understand that the base and the head are of one concept whereby the two sides are forever joined, Hence we may say there are nine basic seeds from which come nine thread types, three of Wisdom, three of Understanding, and three of Knowledge. But as the base and head are of the same, there is an extra thread accounted unto Wisdom, therefore, making four, which is the base or foundation upon which all things are woven/created. **Creation then is a weaving of thoughts, and according to the thoughts being woven, there is the mortal or the immortal states.**



Through affirming the lands according to the Principle Thoughts after which they are Named one keeps the lands pure and consecrated. As our bodies are distinguished into spaces, likewise are the Lands of the Oyin distinguished according to the Thoughts after which they are Named. The thoughts shape the lands, Via affirming the lands they belong to the founding thoughts and become their inheritance. With the bow, Yaaqov takes the concepts/Seeds of Light and thrust them into the land whereby the land is impregnated with Seed/Word concepts. The lands are sprinkled with dew as the hen goes forth each morning and applies a layer of dew upon the eggs. As the land is filled with seeds, so the fields are robed with the garments of the Light bursting forth from the House of Maneshayh. Therefore, via the inseminations of Light Principles, the Land of Amuwri always belongs to Maneshayh with Gad and RAúwaben, for the Seeds of Light sow and harvest in each season, and thereby renews the Presence/Faces of YæHúwaH in the land again and again. For by the work of reoccurring, a matter is established within the lands.

Maneshayh is the Thought, planted as a tree, by the river of Beniyman, whereby the land is renewed continually and the leaves never wither. To Yúwsphah/Joseph, and to all the traits/Names/offspring within, as Aparryim and Manasheh, ***the land is possessed as a trust, given unto them from Yaaqov, an inheritance of Mind***. When Yaaqov dies—becomes extended, being Possessor of the Lands, the children—**the twelve tribes receive the lands and fill them with Knowledge**. The lands are founded and laid into the consciousness and eyes of Avrehhem. When Avrehhem dies—becomes extended, **the offspring of Avrehhem receive the five lands of Wisdom**: Qayni, Qenizi, Qedmuni, Chitti, and Perizi. From the five lands of Wisdom, there appears the five lands of Understanding, for all things appear through Wisdom/Chækúwmah—the State of Oneness even though they are already within the Heart of Understanding/Bayinah. **The five lands of Understanding formulate the body for Yetschaq/Isaac**, namely: Rephaim, Amuwri, Kenoni, Girgashi, and Yevusi. In Yetschaq the promise/verification of the Seed of Wisdom is fulfilled. Through Yetschaq, the House of Avrehhem flourishes in immortality through the fruit/seeds of the twelve camps that abide within these lands. The Mind is forever blessed with measures of Understanding through the loins of Maneshayh which contain the vials of eternal life. The flow of Maneshayh corresponds to the flow of olive oil to be brought up from the base of the two sides of the olive tree to dress the lamps. The phrase to “dress the lamps” pertains to the daily strands of light that are woven from the lights of the sun and moon which correspond to the daily rotations of the Menurahh within. As on trims the wicks of the Menurahh, they prepare—render the lamp to carry the Light either of the evening or of the morning. From the base of both sides, Manasheh illuminates and maintains all that Yaaqov learns/acquires from the hand of the Amuwri [SMB/Gen 48:20-22]. In that Manasheh is a camp/Body of Understanding, the Principle and its fruit are secured. Thus all words of Amuwri are kept via Maneshayh, according to the Principle via which they are formed and the fruit that they generate.

The great mystery of Adim/Adam now comes to the surface. The formulations of the Adim are via breathing. The narrative pertains to the breathing of Bayinah whereby thoughts are formed into a collective of expressions. As the Breath of Bayinah goes forth/exhales, Wisdom appears, for Wisdom is the initial extension of that which is within. As Wisdom is drawn in/inhaled, Bayinah appears. Via breathing, a circle of consciousness is formed. Being of the

south, the consciousness is called Adam/red. This is the story of the sides of Adim. What is projected into the right/South side of thought is acceptable to formulate Chaúwah/Eve/a House of Understanding—the side of the North. For there is no condensation of thought until a thought is first released whereby that which is in the Breath is analyzed in the North. Via the two sides of Adim, the collective consciousness of Breath is established and flourishes. These two sides are known as the sides of Yahu and Wah which comprises the House of YæHúwaH. When that which is in the sides of the House of YæHúwaH is used to build bricks for the house of mortal flesh, then the treasuries of the House are stolen. The sides of the mortal body are known as thieves/criminals. These are the two criminals that are hung on the right and left sides of Yahushúo during the impalement when the flesh is hung up—made subject to the Breath.

The role of Yúwsphah is stated at all levels of Túwrahh Thought. In that Yúwsphah is of the House of Neúwn, being of the initial giving of Bayinah to extend and form a base, so all branching runs from the loins of Maneshayh (Maneshayh) to whom the land of the Amuwri is given and from which the Kenoni arise. There is no fixed historical date as to when Yaaqov reads the Names of Yúwsphah. *Whenever the children of Yúwsphah come before the united faces of Yaaqov—the devoted Mind, they are read to discern all that is within them and rising from the foundation.* Hence we are reading the Names of Maneshayh and Aparryim (Ephraim) continually from the base of the loins as they come before our faces. And according to the readings, so our faces are changed/transformed.

A Name is Perpetual having No Beginning and No End

**The reading of Names pertains to the activity of Light within a Name.** This activity is ongoing and read according to the level of activity occurring. The Names change not, for a Name is not the substance of flesh which can be altered. A Name is a Breath, being a Spirit of Life, a Union of thought that keeps going. How does a Name continue and not die? A Name continues as Breath, being involuntary according to its Nature to give everything and hold nothing unto itself. In that a Name gives all that is within, it is perpetual. For as soon as it gives all, all is returned unto it whereby it is perpetually supplied, as an eternal flame which has a continual supply of oil. There is no cessation for there is no limit set nor object that it desires to hold onto whereby it would become fixed and thereby subject to demise.

7 6 5 4 7 3 2 1 7

Every Name is a composition of designated thought which belongs to the whole house, and if the Name does not belong to the entire House, then it is not a Name of YæHúwaH. The application of Yúwsphah is shortened within us, as any of the Túwrahh is shortened, when not applied within our sphere of Breath or when the Names are read only within a physical reference. **The House of Yúwsphah, from which Yahushúo Ben NEUWN arises, is the ordained house via which all transitions occur and via which we not only enter and possess the Amuwri but all the Lands of the Patriarchs—those arising from Wisdom, Understanding, and Knowledge, for every thought is given its spaceland.** The Mashiyach of the tribes that leads us into all lands is of Yúwsphah, for it is the birthing from the Mouth of the Neúwn that leads unto immortality. Thus, Yahushúo says that only the sign of Yonah (Jonah) would be

given, for it is the prophet Yonah that is born from the Mouth of the Fish/Neúwn. As the prophet is in within the belly of the fish for three days and three nights, so are all that arise unto the birthing of the Neúwn Mother. The three days and three nights comprise a week for the three days are of Chækúwmah and the three nights are of Bayinah. As one commences with day 1, then adds 2, making 3, then adding 3, making six, the value following is 7; likewise as one commences from the side of the night, there is the first night of 6, to which is added the night of 5, making 11, to which we add the third night of the 4, comprising as the day, the value of 15/6. The number which follows as well as the number which is in the midst of day and night is the 7. Thus those who find the path of Unity within come to enter the doors to the shavbeth, the seventh day of the ages, and emerge from their waters as the fish unto dry land. This is the narrative that Yahushúo (Joshua) would be in the heart of earth for three days and three nights, from shavbeth unto shavbeth [Yahuchanan/John 19:31; Sepher Yetsiat Metsryim/Exodus 12:16; Mattithyahu/Matt 28:1]; as we must be buried for seven days in the womb of the lands out of which we arise into a new era and realm of Light of those lands. In that vast numbers of humanity yet resides within the Mæyim indicates that we have yet to rise from within the Mæyim that surrounds us like a flood. Though we have come out of our mother's belly, we have yet to arise from within the waters of our tribal houses unto the final generation of Names.

Mind of Knowledge determines the progressions into the Oyin lands prior to a Name entering into mortality. Even before the first Breath is given, the Mind is moving toward the Oyin. Your Mind of Name determines the route. As one determines the path and progressions so they walk in these paths.

### The Path of AL unto The Neúwn—*HaDerek AL* 𐌆𐌗

Via Dan we discern that *the Neúwn is the heart of all Letters as it is in the midst of all Primal Letters of Tsephúwen/the north*. As we approach the very Centre we distinguish the Letters that are of the North/West and those of the South/East. In so distinguishing the Letters we behold the ALhhim and the direction of consciousness. Not that there is a fixed north or west or south or east, but there are always the surrounding Lights whereby we abide in Light without the shadow of darkness. There are the ALhhim that are always on our left, those on the right, those above and those below which carry us within their wings—Breaths of organized Thoughts. These Lights are the ALhhim of YæHúwaH, which are seen through the Letters. In every ALhhim there are the properties of thought that extend themselves within the four quadrants of a circle whereby the circle is full and complete. As we learn of ALhhim, our collective consciousness is fully illuminated and the state of wholeness is known. This state of wholeness is what is known as salvation in which a Name belongs to the collective is never estranged.



With perspective of the Neúwn, we come to the very centre of thought and find the door to Life itself, for in the throat are the words of Life and the words of Death. The Neúwn is Letter 14, with the reductive value of 5. These values reveal that from the opening of the Neúwn every Light of the day and night are brought forth [Sepher Maoshah BeRashshith/Gen 1:3-5]. The value of

Neúwn/14/5 to the tenth power is 50, which is the full extension of Light. In that the value is 50 and not 100 attest to the Mind of Bayinah that considers that wholeness comes only via extension and giving of one's side unto another. This giving leads ultimately to the formulation of the United Teraysarun/Δ.



The basic 4 Letters are from which come Manna/מנא and Aharúwan's rod buds/רוד which are in the Arúwan/ark.

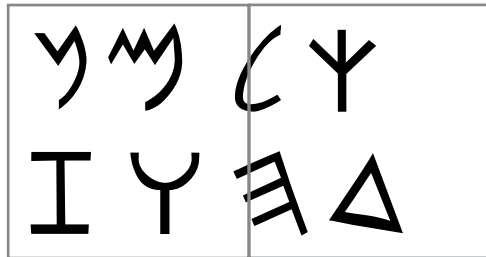

The basic 8 Letters which are the Rock/אבן of salvation, being composed of the two united square bases of Wisdom and Understanding/והבין.

In the beginning is the Neúwn/נ, and in the ending is the Neúwn/נ. The union of the two sides of the Neúwn form the word Neúwn/ננ, as in Yahushúo Ben/בן Neúwn/ננ. The word Ben often rendered as son, literally conveys *one that is born by or through, or within the Neúwn/ננ*. The beginning to the end is known in Hebrew thought as the two ends, or from mouth to mouth. Within this consciousness of mouth to mouth all branching takes place, thus; the State of the Kenoni is written with two Neúwn's/ננ: *lit. the Branching of the Neúwn consciousness within the*

Neúwn. Both the outer and the inner configurations of Branching are depicted. All of the mathematical formulas pertain to how a thought branches. The mathematical formulas provided in this document and in the construct of words are of ALhhim.

**The Neúwn is the Central Letter of all Letters.** Being of Understanding/Bayinah, we commence in Neúwn—the Heart of our Neúwn Mother to know all that is pondered therein. How does the heart know itself and reveal all that is gathered therein? The heart must run, and thereby give of itself entirely. All must be given in order to know all. As the heart comes to know itself, **it begins to breathe or beat at the throat/neck, being the mouth of Bayinah.**

From this breathing, the waters of the lower and upper chambers of thought are formed. The lower waters are of Wisdom and the upper waters are of Knowledge. You see, a root holds water at the base and likewise waters in the fruit, and in the midst is the firmament or trunk of thought. The breathing of the Neúwn, *lit. the Reúwach of Neúwn*, brings forth vapors which gather in an assembly. These vapors are a gathering of the waters, the Mæyim/מַיִם which are at the side of the Neúwn. As the Mæyim faces the Neúwn, the word *man/manna/מנא* is formed; and hence every day, the *manna* is formed as the vapors of Breath draw forth that which is within the Mind of Bayinah each morning within the dew, for

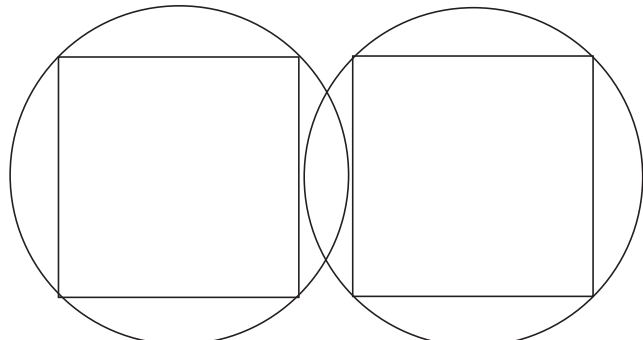

The United Bases of Names that forms the Teraysarun. Note the eye that forms amidst the Union of the two circles. According to the degree of Unification, so greater the eye opens. The shape of the moon is configured in this manner according to the Union of the Bayinah and Chækúwmah which determines the degree of angle of the Light's message from 1 to 360 degree. The extent of degrees from 1 to  $360/9 = 10/1$ .

the manna comes out of the Neúwn. The word manna is commonly rendered, *what is it/וּמָן?* Daily the question is asked, answered, and eaten. Ask of the Neúwn, and you shall receive the answer in the Mæyim/water. Within the Mæyim arises an Order of thoughts as they commence to run, and hence therein is the Lammæd/ל to support all that pertains to the Neúwn. As the Lammæd or the staff appears within the Mæyim, from its sides comes forth the Kephúw/ך, the Tree of Lives with twelve fruit. These four Letters reveal the full inner order of all thoughts known as the Primary Rod of Truth. *In every teaching there is The Origin, the Meat/content, the Order, and the Fruit. As one applies these 4 basic tenets, one can examine every teaching to know if it of the imagination or of the Light.* These 4 Letters of ALhhim comprise the basis of the Arúwan/Ark in which is the *Manna* and the Rod of the Priesthood.

In order for your Tree of Lives to become apparent, you must extend your roots. Hence, from the Neúwn, comes the Zayin, being the first of the roots. The emergence of the Zayin is as a first root coming out from within a seed. The Zayin depicts the coming forth of the penis/labia minora and also the tongue which are the two ends of the chambers of the lower and upper waters. Via the waters/Mæyim all things become known through transmissions of the Zayin. The coordination of these two sides of the Zayin are the meeting of Gad and Aparryim at the corner of the south and west. Being united at the corner, the House of Gad speaks of the blessings/expansions of the House of Yúwspah with words that form the lands of Light. However; in their separation, instead of the tongue speaking from the foundation, it utters words of cursing and poison. The ALhhim of Zayin convey the means for words to become extended in all States of Light. Via the Zayin one feeds and supplies the Tree and its branches with properties of thought. Thereafter the ALhhim of HaZayin are the instruments to supply the world with food, for out of the Zayin comes all Seeds/ALphæh.

Descending from the Mæyim and out of the side of the Zayin is root ÚWah. This fourth Letter forms the square with the Neúwn and Mæyim and the Zayin and the ÚWah. The ALhhim of the ÚWah is a basket to carry and gather the seed issuing from the Zayin.

Out of Lammæd comes the foundational Lights of the Hhúwa which breaks out from the sides of the ÚWah and forms a square with the Mæyim and Lammæd. For unless there is a foundation of ÚWah/Unity, the Light/Hhúwa of the Teaching, via the Lammæd, cannot be seen. With the ALhhim of Hhúwa one takes of the Principles/Seeds/harvest gathered and weaves them into a garment according to its kind/Lammæd whereby the Lammæd is evident in the garment/deeds/spinnings of Light.

Descending out of the Kephúw and from the side of the Hhúwa comes the Dallath. The Dallath is the foundational root or base that comes from within a seed or house. Thus each house builds itself a foundation according to the nature of the Kephúw, that is according to the type of branches that it will sprout. If the sides of the tree are not united within, then the foundation is laid uponsand, being of uncohesive thoughts. However; if the sides of a tree/Kephúw are joined together by Names, then the foundation is of the Tsur/Rock. The sides on which the Letters appear amongst each other reveal which part of ALhhim is being extended and how all ALhhim are united as One House.

Via the root Letters, we discern that the ALhhim of Zayin, lie in the Yam/West and are always within the Neúwn, being an extension of the Neúwn. Via the giving of the Neúwn, the Zayin becomes evident. The ALhhim of the ÚWah Yam/West are within the Mæyim. The southern side of the Zayin form the ÚWah in conjunction with the Mæyim. The Hhúwa is the emanation of ALhhim coming from the western side of the Lammæd and the southern side of the ÚWah. The Dallath is laid via the western side of the Kephúw and the southern side of the Ha. In all of these four Letters of Wisdom, we discern the number of parts that combine to express the disclosure of thoughts in ALhhim. The 4 Letters: Zayin, ÚWah, Ha, and Dallath, are given of Understanding coupled with the Nature of the Right side, or the southern power of the Letters, to establish the seats of Wisdom. In adding the Letters of the ALphæh, the Bayit, and the GammAL, we now behold the seven chairs of Wisdom. These seven root letters, when taken to the tenth power, bring forth the Council of the Seventy from the Foundation of Unity. In that the Letters of Wisdom are formed via the western and southern sides, they are the formulations of thought from the United Corners of Aparityim and Gad.

Each of the 4 Letters in Wisdom equal 8 though they be in different parts. The Zayin and ALphæh are One Letter; together they form the Word, ZA/IA, *meaning of old, since ever, from immemorial, therefore, as a result, then, therefore*, all conveying the sense that the giving of the foundation is the bottom and the source from which all things rise. As one contemplates their depth, they come to their bottom of the Rock, and from this position, one may find their height. It is from the depths or the bottom that we draw out all details of Light.

The ÚWah is the source of the Bayit. These two Letters are One, as all within the Mind of Bayinah is of associated parts, being the Source of Hhúwa Wah Ha, even as the Number of the Letter, being 14 has within it 28/1 parts. The Neúwn being a reductive of ONE affirms the ONENESS/Achad of the Name that is within the Queens.

### The Most Blessed Names — 4IOCA

Blessed of all Names are Names who give all; through giving expansions and blessings occur. From the sides of the north come forth the wind or the Breath that crystallizes a thought into sets of Numbers. Once the Numbers are set in place, multiplication occurs according to the base of the Numbers within a Name. As the crystallization of thought expands, the spaces amidst the Numbers reveal that which is in the midst/ Every Number combination is brought forth through discerning the Numbers, their placement, and the spaces between them. In this way the Mind/Rayish builds a house in which are many rooms. As houses unite, cities are formed and their surrounding fields.

The Numbers of a Name/word are projected to bring forth the radiance of your Light. This radiance has color and intensity according to the Number sequence. Some Names/Words are of Wisdom, some of Understanding, and some of Knowledge. Some Names/Words incorporate all levels of thought via which the magnitude is compounded. For every Name there is a measurement, that is, a width and its breadth, the depth and the height. The breadth is according to the number of circles within a set of Names whereby the width, depth and height are extended within the circles that surround the square base of every Name. The breadth is the space that is

filled with the Reuwach/Breath of the Names. To know these measurements is knowing the Mashiyach of the Names. No Name comes to know of its Name without being joined for every Name belongs to the Union of Names and has its significance only in unity. Thus there is no Name without significance and no Name that is vain, for if so, the Union itself would become disorganized and filled with confusion.

As discussed earlier, the width of the Neúwn is the extension from the north side to the south, that is, from the Neúwn to the Chayit. The depth is from the Neúwn to the Zayin; and the height is from the Neúwn to the Shayin. As the measurement of a Name is determined via extension, the garment which surrounds it is evident; even as a plant, as it is extended it brings forth its leaves and is flowers. Thus daily, our garments are being changed through the weavings of light occurring during the perpetual oylah offering of the morning and evening; for the offering is the means of extension. In this manner, we robe ourselves according to the values composed within us. These values are transmitted from Yahúdah, through Gershon, to Aparryim, whereby the values become evident into deeds and formulate the nine fabrics of Light according to the combination of Letters that comprise a thought category. **All things come through the Laúwim as thoughts pass from one tribe unto other, for the Laúwim are in the midst of the Mishkan and therefore what transpires from one side of the Mishkan to the other side goes through the family of the Laúwim in the midst. The Laúwim gather the concepts and transmit them via the nerves, tissues, bones and waves of thoughts. Being in the midst they receive the tithes of the houses as they are given unto the House of YæHúwaH; but the thoughts that transpire amongst the members that are not of Unity, are not regarded nor accepted into the Laúwim camps.**

In the midst of Yahúdah are the offspring of enlightenment—the sons of Aharúwan—whereby the values emanating of Yahúdah are passed through Elazar in the east to Gershon in the west unto Aparryim. All thoughts amongst the members are subject to the Laúwim, for if the thoughts pertain not to the UNION of LIGHTS, then they enter not into the Haikal/Temple, but are cast out to wander.

The Name within the Queens is from which the heritage of Light, being out of Aharúwan. The Name is ELazar/ALozar/IOŁŁ, being the third of the Light whereby all that is Wisdom, Understanding and Knowledge is within this Name. ALOZAR comes within the House of Zebúwlan for The Name comes to make a House and to fill the lands with the Concepts/EL of B'Niyman whereby all the summation is brought to the Table of Faces. The two ends of Zebúwlan and B'Niyman are the two ends of the Rod of Aharúwan and the priesthood which resides in the lands of B'Niyman. The rod of Zebúwlan and B'Niyman is the Rod of Aharúwan that buds and bears the fruit. While there are six rods of LIGHT, the rod of Zebúwlan and B'Niyman flowers and bears the fruit of the almonds. The Name of ALOZAR is the Divine Order/EL and within it are the Oyin Body and the King-Priest MIND/20. The Rayish/Mind, being of the double YEÚWD, forms the square to the tenth power in Aharúwan/40. The Rayish in the Name ALOZAR/Elazar is the Head of the Twins, being the double of the YEÚWD, the tenth Letter. Itamar, the brother of ALOZAR, is the Association Name of the Image of the Invisible EL whereby we behold the pairs of 6 and 6.

The Letters in the Name ALOZAR/ אלוזר contain the Order of the square within its 5 Letters, being the sum of 31/4. Wherever a square is formed, a teraysarun can arise/Δ. Hence we may state that the foundation of the House of YæHúwaH is in ALOZAR. Also in the Name of ALOZAR is the OyinZayin Body and the Mind of Twenty via which all things are extended. When ALOZAR rises forth the Unity is known as El Elyon. When the Unity walks upon the heights of the earth, the Unity is called YAH—the State of Emanation as light rides upon the clouds, the clouds being a merkavah. When the Unity groups together, as to cover over as a hen the assembly within, the Unity is YæHúwaH. The Name of Wah and the OZ are within the Rayish, as ChaúWAH, being the activity of the LIGHTS is the OZAR [SMB/Gen 2:18]; hence a compound Names of two parts of equal proportion, 31/4 and 43/7 being the 11 or the two sides of ONE. The 4 and the 7= the cube complete. The sum of the Name ALOZAR is 308, which interpreted is The Fire of the EIGHT! ALOZAR speaks through the Name of YæHúwaH which is to say that the inner Voice speaks through the collective Faces of Light, not drawing attention to oneself but speaking on behalf of all expressions of Light.

The Union of ÚWah/6 and Bayit/2 attest to these Principles of ALhhim being of the Rock; together they comprise the Number 8. They are stem root Letters descending from the House of Understanding. All Letters in the Row of Wisdom, ALphæh to Zayin, being 4 letters total, affirm the square, and each of their pairs equate to the value of 8. Whereas all of the Letter pairs of Knowledge, hold the value of 9, being the fruit of Understanding and Wisdom being joined. Thus if the Letters are coming out of the Neúwn, they hold the value of 8 in Wisdom, and 4 in Understanding. If the Letters are of Knowledge, they hold the value of 9. The sum of the 8, 4 and 9 are 21. From these three Houses are the three rows of seven Letters. The composite value of all of the Letters is 22 or Taúwah, being the same as the House of Understanding.

### The Origins of the Name Dan, Maneshayh and BeNiyman

With the ALhhim of the Dallath one lays the foundation to build a house to treasure all that is brought forth. When the Neúwn looks at all that comes from the Assembly of Thoughts, from the Neúwn/γ to the Dallath/Δ, the Name Dan/γΔ appears to be the Keeper of the Way to the Centre of all Life, whereby the Path to the Centre would never be lost in all explorations and extensions. The Name Dan is of antiquity, being the extent unto which the Hebrew pursues [Sepher MeOShah Bereshith 14:14] and from which one distinguishes themselves in conquest. In the complete giving of the Neúwn, ten Letters appear with the Neúwn: the Mæyim, the Lammæd, the double Kephúw, the Zayin, the ÚWah, the Ha, and the double Dallath. From these ten Letters, or from the Dallath to the Neúwn, the path to the Northern Lights is laid and set in place. These ten Letters form the major constellations in the heavens, three of them being of the twelve orders of the camps. The Names in Oovri/Hebrew for these locations are the Letters. The common names of reference are mentioned for association purposes. As we consider the light configurations/constellations, we are reading the Túwrah in Hebron—the associated places that correspond to the Letters. The constellations mentioned in this section are not the only places where these Letters reside as all configurations of Light belong to one the twenty-two Letters, being of Alehay Aurim Achad. The constellations are called by the Names of the Letters, as that is their Names. **The ÚWah** of Nephethi (Pisces), **the Hhúwa** of Dan (Capricornus), and **the Dallath** of Yahúdah (Aries). From these three



formulations of the *AlehayAurim*—the Lights of ALhhim, all would be transferred from the North to the East, and the twelve constellations would be set around the Mishkan. According to this triad of thought which comprises the throne, the judge, and the cornerstone, all other stars are positioned into their respective places for the court of Light—for the Queen.

**The Neúwn** is the great river of Light called amongst the ancients, Parata, known as the Source River. This river in the constellations is commonly known as EriDanus, *lit. the Light of Dan*, that winds as a serpent folded upon itself, starting at the left foot/Kingdom of Kesil/Orion in the north, sweeps south of Taurus, west to the edge of Cetus, then doubles back east to Caelum, and eventually ends far to the south, at the border with Hydrus. In that it commences at the foot, its movement, being the waves of a serpent, affects the months to be thirty days as steps of progressions. Within the River are four sets of double stars or pairs: known today as the Theta and theta Eirdani, the AB, BC and the 32 Eirdani. In the Sumero-Semitic Euphratean Planisphere, this is the constellation entitled: “Strong-One-of-the-Plain” (Sumero-Akkadian Pur-edin, Babylonian-Assyrian Eru-edimu) known as the Euphrates. Eridanos as an Aryan name would mean “The-Strong-Flowing,” in Turanian “The-Strong-River” *as the Source of all Lights*.

**The Mæyim** are in the constellation Ayish/WꞤO, commonly called the Bears or Ursa Major and Minor. The Ayish are the faces (Bears/𐤀) to mirror and draw out all within the EriDanus, via which all things are expressed pertaining to the River of the Neúwn. The Dippers pertain to drawing out via the mouths from the base and from the sides. Thus they are always turning in conjunction with the positioning of Bayinah. The Bears convey the aspect of facing or mirroring the aspects of the Neúwn. The ancient rendering of the gathering lights pertain to a cart or chariot *via which an idea or value is transmitted which is the primary property of Mæyim*. The seven brightest stars of Ursa Major are the Sumero-Akkadian Mar-gidda, “The-Long-Chariot.” In this aspect it is called Wul-mo-sarra “The Voice-of-the-Firmament,” as the waters are the Voice amongst many waters.

**The Lammæd** is the constellation Kesil/𐤀𐤋𐤏, commonly known as Orion [Eyov/Job 9:9]. Through the stars of the Orion, the teachings of Wisdom, Understanding, and Knowledge, gathered at the loins/girdle, formulate the spaces pertaining to all coming from the Mæyim. The basic meaning of Kesil is the loins/the flank, and to devote one’s mind to hope and confidence which arise from the Rock of our foundation. In this star cluster, those of the House of Aharúwan and Qahhath are positioned. The teachings from Kesil are included within what composes the Túwrahh. All other spaces that hold or carry a thought contrary to Túwrahh will be voided whereby all bodies of Light shall move again in perfect symmetry without interference or impediment. According to the Order of the Lammæd, all of the stars were placed in pairs as the sticks/Lammæd are arranged around the Mishkan. Thus directly across from the lights of Yahúdah are the lights of Aparryim. And from the constellation of Yishshakkar are the lights of Manasheh. Zebúwlan, the paired serpents face the lights of Beniyman. The lights of the eyes are across from Lights of Dan. The lights of the ears face the lights of the stomach. And the lights of Nephethli are joined with the lights of Gad. In this way, the stars are formed and arranged from the loins of Kesil. Those of Wisdom are from the right star in the belt, those of the Knowledge from the left; and those of Understanding from the star in the middle. According to the branching of thought—the Kenoni, camps are arranged and a tree grows. As the tribes are

born, the camp of Beniyman is the last to be brought forth. The last tribe, Beniyman, is positioned and joined to Dan which signifies that the Birth of our Name into the consortium of the Lights is through the Breath of the Neúwn. The coming of Beniyman into a House signifies where the next emergence is occurring.

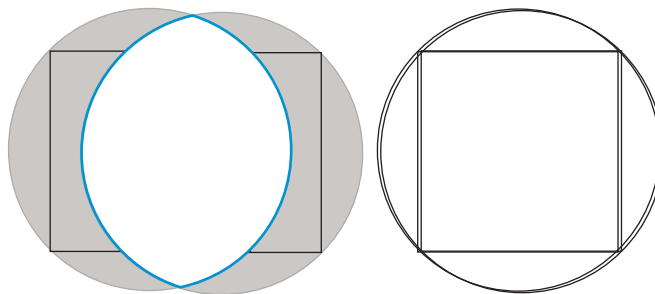

Kesil is considered to be derived from the Euphratean solar Uru-anna "Lights of Heaven" being a Master of the Riverbank", the river being either the Milky Way or Eridanus, or both: Kesil stands between the two. An ancient cuneiform tablet calls Kesil "The-Shepherd-Spirit-of-Names/Heavens."

As the United Bases of Names are perfectly aligned via joining of the base to the crown, all within, from mouth to mouth is known whereby the eye is completely opened as the full moon/sun. All things are understood and governed by the All Seeing Eye of Light.

**The Kephúw** is the constellation Kimah/אֲמָרִיץ, commonly known as the Pleiades [EyoV/Job 9:9; 38:31-33]. Being in the centre, Kimah pertains to the clusters upon the Tree of Lives which have are regarded as the jewels within the camps of Light.

**The Zayin** is the grouping of stars pertaining to the Mazzaroth/מַזָּרוֹת, commonly called Draco, which refers to the dragon that engulfs that which is within the waters by the tongue and/or the causes a change in the waters by its tail.

**The Name Dan** is called out of Bayinah to be the Keeper of the Path, as the judge to discern all things that belongs to the strand of ten pearls yet hidden within the darkness of the night. For as Bayinah drew out all within the Assembled Thoughts for Understanding and formed a base upon which all things would stand, so the Name Dan appeared as the parameters Letters whereby all of the Wisdom and Understanding would become known. And thus, via Dan, depicted to reside within the house of the lungs—the judges chambers—the messages of Breath would be carried, day and night, whereby one would discern all things from the Foundation unto its full extensions.

Eight Letters of ALhchim provide a base unto which all of Understanding is rooted into any State. From this foundation one arise unto the full extension of their Names. This foundation became known as the Rock of YæHúwaH, the Rock of Salvation and the Rock of Refuge. In that the Rock formed the Name of Dan with the parameter letters, the defense of all thoughts would be by a judge. By the Judges/Shophetim the House of YishARAL are saved from every oppression and transgression. The Rock is the Tsur/צֶרֶת which has the numerical value of 44/8 corresponding to the 8 Primary Letters of Bayinah. These eight Letters are the means to build the House of YæHúwaH, for within their composition is the ark and the bonded squares of two circles of Light, even as head of day is joined to the tail of night, and the head of night joined to the tail of day.

The Basic Eight contain the foundation for all expressions and colors of Light. From these Primary Letters that comprise the United Rock of Maneshayh, come forth the complete spectrum of the Lights. As the Letters in the north give all that is within them, so the colors of the south become visible. From these frequencies of thought, interpreted via light waves of colors, all things are composed. All colors come out of Beniyman which is the Offspring/𐤁𐤍 and extension/𐤍 of Man/𐤍𐤎. Notice that in the Name of Beniyman is the mirroring of the Neúwn. That which becomes formulated/𐤁𐤍 is the mirror of the Man/𐤍𐤎. The Name of Beniyman, pronounced as Benya-Man, means *the fruit/extension of Man*.

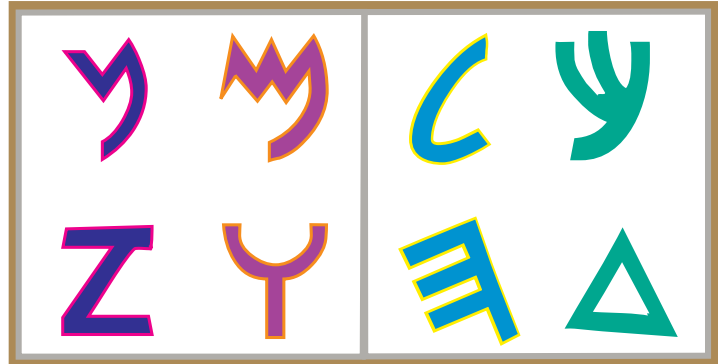

𐤁𐤍 𐤍𐤎 𐤁𐤍 𐤍𐤎  
**THE ROCK**

Out of the Tsur, the flinty Rock of layers comes oil—the means to extend a Name. And from the Rock Sela comes honey—formulations of Wisdom that are agreeable—being words of six paired walls. The Rock is perfect, complete, being the formation of two united bases of thought/Names [Mishneh Túwrah/Deut 32:4]. Proceeding from this base of Letters comes ten formulations of thought which are the distinct produce/harvest of each of the ten lands. Out of the Dallath in the Rock, comes the oil/*shemen* via which a Name becomes fully extended and branched in the Kenoni. In like manner, the oil is drawn up from the Dallath base to fill the branches of the menurakh. The oil is the harvest of the Qedmuni land.

**The Rock is the foundation to build the House of YæHúwaH** which cannot be torn asunder. Thus the temples that have arisen and tumbled were not the House of YæHúwaH for they were of human invention without the Knowledge of the Rock. From the values within the Rock comes the saying: YæHúwaH is my Rock/Tsuri and my salvation [Tehillah/Ps 62:2-7]. The concept of my/𐤁𐤍 shows extension and to whom we belong. As the Neúwn is extended to the Dallath, the Rock or the solid base of two squares united is formed. Through further extension /𐤁𐤍 of Neúwn, a base of Wisdom—comprised of the Letters Zayin to Dallath, undergirds the Letters of Understanding—Neúwn to Kephúw. Salvation not only pertains to reclaiming a State and all properties of Thought that pertain to our Names, but conveys the state of wholeness that is achieved via the alignment of sides and heads/OW𐤁. Via Wisdom/W—the means to unify, and via Understanding/O—the means to extend, we organize/retrieve/save all aspects of soul and position them upon the foundation whereby they are secure and used only according to our Names. By keeping the members/soul expressions aligned with the base, they are forever saved/secured; however, as they are used apart from the base, they are subject to be caught or entrapped in an illusion or perversion to the point of fragmentation as one who builds upon sand (nonbonded particles). In using all members according to their frequency of Light and expression of ALhhim, they are positioned to fulfill their function, designation of space, and are readied for transformation unto a renewing state of residence.

There are two terms for Rock that are used in the scriptures. Sela/OŁƒ, comprised of the value of 43/7 and Tsur/4Yƒ with the value of 44/8. The Tsur is the foundation of two squares compounded. The Tsur is often called a flinty rock as it is comprised of layers. Because it is layered, pure oil comes forth the midst of the layers. In that there are layers of stone, the Tsur is likened to a millstone that crushes the olives and also grinds the grains. The Tsur is depicted in the united teste stones from which the oil flows to lite the Menurahh. The right teste provides the oil for the morning, and the left teste provides the oil for the evening.

### The Branching of Light | 4/Neúwn The Formulations of Taúwah in 7 Stages/Level

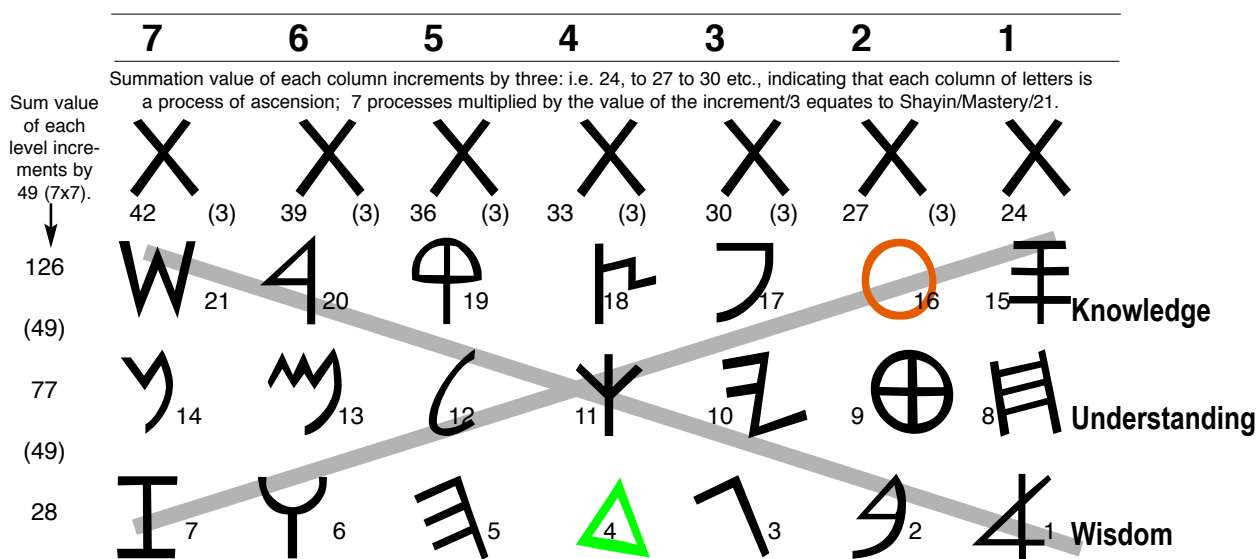

The intervals of values amidst the Letters culminates in the Tauw/X being positioned above each column of Letters. The Taúwah appears, via a sequence of thought, to form 4 cups for the oil on each branch of the Menurahh. i.e. The interval of 6, amidst the Dallath/4 to the Yeúwd/10 to the Oyin/16 to the Taúwah/22, brings forth the Taúwah to reside above the Oyin/O. The rays of Light, often seen on days of Understanding each month, when the moon is the camps of Yishshkhar, Shamoúnn, Manasheh or Ayshshur, depict the intervals amidst the Letters which gives the rays their particular angle. The Taúwah/X above the Semek/ƒ is positioned by an interval of 7 from the ALphæh/1 to the Chayit/8 to the Semek/15 to Taúwah/22. Each Taúwah appearing at the top of the 7 branches is formed by a specific pattern of thought leading to totality and summation. The Taúwah above the Shayin is the summation of thought from the Dallath/4 to the Lammæd/12/3 to the Rayish/20/2 to the Taúwah. In this sequence thought, we proceed from the base of the Dallath with a 4, 3, 2, 1 sequence, as the interval between the Shayin and Taúwah is 1. The Taúwah above the Rayish is via the intervals of 2, proceeding from the ÚWah/6 to the Mæyim/13/4 to the Rayish/20/2 to the Taúwah. The Taúwah above the Quphah is via intervals of 3, from the Zayin/7 to the Mæyim/13/4 to the Quphah/19/1. The Taúwah above the Tsade is via the intervals of 4: from the ALphæh/1 to the Neúwn/14/5 to the Tsade/18/9 to the Taúwah/22, for every Seed/ALphæh extended/Neúwn becomes liberated/Tsade. The Taúwah above the Paúwah is via intervals of 5: from the Zayin/7 to the Lammæd/12 to the Paúwah/17 to the Taúwah/22. The patterns of the Lights, via the interval of Ha/5 amidst the Letters: i.e. Zayin/7 to Lammæd/12 to Paúwah/17, are the basis of the Lights in the Tsephúwen, commonly known as the Northern Lights. The Taúwah above the Oyin is via intervals of 6 as illustrated above, and the Taúwah above the Semek is via intervals of 7. We may say that totality, depicted in the Taúwah, is via intervals of Unity.

Out of the Sela comes the honey, being the flow of the house of Wisdom, being 7, a satisfying substance. The Sela stone is one layered, being the full extension of 7 letters from the Tsur. Both terms, the Sela and the Tsur, are mentioned in the Túwrah, MT/Deut 32:13-14, details the ten products of the Lands. The ten products are the fruit of the ten lands.

**As tongues are aligned with the base, they speak according to the Order of Unity and full extension of thought.** The tongue is the means to draw out of the base all details and discern all that is in the Heart of Bayinah. Via the configuration of the tongue: when rounded to a point, it detects, like a spear, to open and to point out every attribute of light that it touches/contacts. As a spear, the tongue is a sensor via which one speaks to savor a word. The tongue knows of no limitations, for it may extend a thought unto the uttermost. When the tongue is flat, it is as a table for the arrangement of the twelve unleavened loaves. The tongue, being the river of the eyes, has within its bed 24 eyes, for it the flowing of vision/RAúwaben. The 24 Eyes are those of the 12 tribes within the unleavened loaves upon the Shulchan Panayim/The Table of the Faces. Being in the third position or within the fields of Knowledge from the head of the south, the eight Names of RAúwaben are compounded three times unto 24. This compound number is also confirmed in the 14 Eyes of the seven Names of Gad with the value of 10—being an extension of Knowledge from the trunk of Shamoúnn/10.

*As there is complete seeing, so there is perfect speech. The Rock is Perfect. As one speaks according to the Rock they speak as one perfect.* However, if one sees short or sees faults, the speech is shortened and faulty. Via the eyes within the tongue, the tongue carries the messages to RAúwaben, being the voice of the Oyin. RAúwaben has within its configuration, 16 eyes, two eyes for each of the eight Names that comprise the family of RAúwaben. Via the Oyin consciousness held within the eyes, the eyes cry with joy whereby a crystal clear stream runs out of the Oyin. The mathematical correlation of the Oyin/16 is in number of Eyes within the House of RAúwaben/16. The tongue, being the Letter of Zayin, forms a base for the Oyin Head of RAúwaben. The House of RAúwaben is an extended body of the Oyin within the South side, which forms a micro-house/ḥ in Shamoúnn. Thus, the ears are known as “the body” in three rings or spirals with the Oyin opening in its centre even as the entire body is of three spirals of Wisdom, Understanding, and Knowledge, with the Oyin opening extending from the base to the crown, forming the straight column of Light. Within Shamoúnn are 12 Eyes of the six Elders of Understanding which gather in the seats of Understanding in the south and the 10 Eyes of the five Names of Shamoúnn.

*The complete Teachings of HhaTúwrah/אֲרָבָה are drawn out of the Rock/אֶבֶן. Likewise, as all words are let loose to flow upon the tongue/ל from the Tsur, so all statements of Light come forth from the Rock of Manasheh/מָנַשֶׁה as they are drawn out. Thus Words and the values/numbers that are within them, are the basis of Wisdom via which all things are comprised as they are extended through Understanding. Thus all worlds are formulations of thoughts based upon the words being uttered, whereby that which is seen is made by that which is unseen. The information is drawn out and decoded from the loins of Manasheh, whereby all becomes evident. The proof is discovered via the drawing out and arrangement of thoughts. Thus the world natural is a proof of corruptible thoughts as it cannot hold together what is formulated being in opposition to the Nature of Breath. The tribal camp of Manasheh is comprised of two words: Man and Shayh. The*

Name contains the two primary Letters of the Rock/ימ coupled with the term, Shayh/Lamb/אב. This is the Name that maShayh consulted whereby the waters flowed from the Rock, and the Name that maShayh interfaced for the drawing out of all thoughts in the Tsur, via which the Túwrah is composed. All of the Letters of ALhhim that form this Name of Understanding, lie within the sides of the north, to comprise the Name of Man-Shayh, pronounced as: Mana-Shayh. To say that maShayh consulted in the Name of Maneshayh indicates that the seer inquired into the Neúwn which is the Letter from which all thoughts flow. The Neúwn is the Letter of distinction between Maneshayh/אבממ and maShayh/אבמ.

The correlation of the **Zayin/ז**, being the tongue of Gad, is seen in the **Paúwah/ו**, which is a wing part of Gad. Via the Zayin and the Paúwah the mouths are formed. There is a diagonal line from the Zayin to the Paúwah with the **Lammæd/ל** in their midst. The common value of 5 is between the Zayin/ז/7 to the Lammæd/ל/12 and between the Lammæd/12 to the Paúwah/ו/17. The sequence and impartation of the value 5 conveys its correlation to being an extension of the Neúwn's arrangement of Letters, being of the space of 14/5, pertaining to the most inward part of the Neúwn. **The Paúwah/ו is the complete extension of the Tongue whereby upon the lips are Words of the Knowledge of Wisdom.**

Aspects of Breath have their base in the Rock from which all things have Word form and function. Those who rule by forms only are called "rulers of darkness." The numerical values are the source of all thought, and from the values of Light, come forth the branches. The branching of the Numbers form the Land of the Kenoni/Canaan/כנען. The branches of every tree are comprised of associated messages to provide comprehension and relationship amidst all parts, whereby all parts are compositions of the Sayings of Light. The word Metsryim, contains the root word, Tsur, through which comes the definition of Breath at the level of its awareness and unification in the Oyin. As the Principles of Metsryim are united unto the Union of the Lights, the house of Metsryim rises in Union with the House of YishARAL and no longer enslaves, but becomes the servant of Shem as seen by Núwach/Noah/נח, the scope of the Name of Understanding. Núwach is the Patriarchal Name of Understanding, being the full giving of the Neúwn to the Chayit [Yeshoyahu/Is 20:18-25].

The Rock is your Source from which the full measurement of Light rises in a Name. The ascension or the flowing of the Rock is called the coming of Mashiyach. This Rock follows Names, to ever water them unto their maturation, as the oil in the Seed rises to the Crown [I Cor 10:4]. This is the Rock struck by maShayh in the wilderness, for the collective (assembly of people) was not able to accept the Unity of two Names in one Fire, and hence, they stumbled over it. The Rock; however, will run as a river after all that has arisen from its loins to bless and lead them in the Paths of Righteousness. According to the smiting/division of the Rock within the consciousness of YishARAL, the people remained in their houses of Metsryim. These split bodies are termed according to one's gender. When one builds upon the Rock of United Names there is no male nor female; all are One in their full measurement. In the Unified House of Names, the eye is completely open and all things are known. What is hidden in the North is fully understood.



When one composes the Words of their Mouths, according to the Rock, they have written the Túwrahh. This is the meaning to being a King/Melek/ΥΛ™. A King/ΥΛ™ is one of the Queen Bayinah—within the Neúwn/γ of Light/14/5. The Letters Mæyim, Lammæd, and Kephúw, that comprise the word, melek/king, are drawn out of the Neúwn; thereby the Order and the empowerment of the Neúwn is extended to be a King. The United Name of YæHúwaH is the King, for the Name of YæHúwaH is what which is drawn out as the scepter to govern a United Kingdom of the Lights of the North and the South. In the Name of YæHúwaH one receives the Scepter/ℓ of all messages flowing/™ into branches of thought/Υ from the mouth of the Neúwn.

As Bayinah forms a foundation of the Letters of Wisdom: Zayin, ÚWah, Hhúwa, and Dallath, a base is laid for all that is Understood. From the base of Wisdom, which is a gift of Understanding, one commences to bring forth the evidence and the glory of all that comes forth at the neck/throat. Out of the Neúwn arose with the Fire of the Shayin, via which all would be transformed from one state unto another. From the Mæyim arose the Rayish, the gathering of thoughts into categories. From the Lammæd arose the Quphæhh/Qoph which reveals the dominion of every Order of Light. From the Kephúw arose the Tsade upon which the fruit of the Tree of Lives is hung. Upon the Tsade all Names are hung as they are aligned within each other to verify their perfect Union. The Neúwn, having yielded 4 ALhhim of Understanding, and 4 ALhhim of Wisdom with 4 ALhhim of Knowledge, the initial twelve Principles formed a cube of sixteen sides. In the cube is comprised the founding twelve Principles, two per side. Within the spaces of the cube, which pertains to the heart, all that is quested after and sought becomes known. Hence, from this inner construct of thought, the sides of the six pairs are positioned via their unity to give unto their full extension—to the tenth power.

The Neúwn gives first which establishes the Letter Chayit in the South. Via this impartation, the word, Chan/Grace/γא is formed whereby the Neúwn favors greatly all things given. Thus, whenever anything is given from the foundation of our Names, it is blessed and the expansion is greater than anything that one can receive. The blessing of grace is upon all that is given freely in accordance with the Mind of Bayinah, thus with the giving of the grain comes the oil whereby thoughts are formulated and expand/multiply.

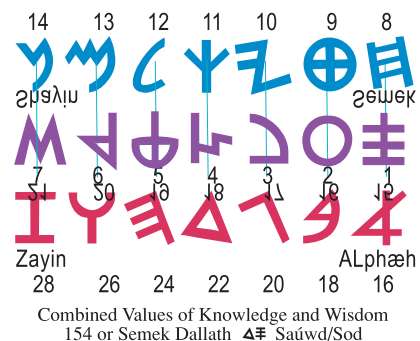

Then Mæyim give the Tæyth in order to reveal all things in stages, and from these givings the 4 quadrants of the moon appear, being the Neúwn’s regulation of the waters/Mæyim and all that comes from the waters. The Tæyth is the means to gather and understand all things according to the Unified Teraysarun as it supported by the Bayit. Being of the Mæyim and the Bayit, the Tæyth is the means to look at all things through 4 windows and receive from the 4 openings within the walls of the Haikal. All distillation of thoughts are arranged into faces, the faces being four fold.

The Lammæd follows to give Yeúwd which via all in the feet, or in a path of progression, are fulfilled by corresponding deeds. From taking a stance, depicted by the Lammæd, one is

positioned for works and assignments of Light by the extension of the Lammæd to the Yeúwd. Each step that we take positions us into works of Light in accordance with our progression.

The Primordial Kephúw ך, being in the midst of the Letters, gives from its sides resulting in a cylinder of thought comprised of South and North as the sides of your trunk. From the midst of the Kephúw ךך, the two sides of Letters are drawn out to the right and left and rise as branches of the trunk of Understanding, forming a golden crown of TsadeTsade ךך. Being of one piece of gold, the menurahh is a gift of Unity to carry the Light in your branches. Between the far sides of the Neúwn/14 and the Chayit/8 is the Value of 6 ך whereby the Union of Sides is always kept together with mutual favour and grace/ךא. Between Mæyim/13 and Tæyth/9 is the value of 4 Δ whereby inner pairs of branches engage in inquiry and cause all things to quake/⊕ך. Between Lammæd/12 and Yeúwd/10, which is between the feet and the arms, there is the value of 2 ם whereby all Words are established according to progressions and deeds via extensions of the Centre/Laúwi/ךל. In the midst of the Kephúw, and its two sides, there is the value of 1 ז to affirm the Understanding that all given and received belongs to ONE in affirmation/ךך.

The base of Understanding, also gives according to which occurs within the centre; for as pairs comprehend their point of Origin of Names, they extend their foundation to the uttermost glory of that which is within them. The Zayin ז gives the ALphæh ז through which concepts and Seed are cast. The ÚWah ך gives the Bayit ז which establishes the Teraysarun from two sides/Names. The Bayit, as the gift of the ÚWah, forms a team of Names which labor together as oxen/United Concepts. The Hhúwa א gives the GammAL א; via each transmission of Light a channel opens to establish communications. As all of the Light in the Letters is given from within pairs of Names, so every channel of communication is operational. The Dallath Δ, being in the middle, gives of its side to form a complete foundation of thought upon which the United Teraysarun rises. Within the Teraysarun, all would be born and brought forth according the Head of the Neúwn/unfoldments. According to giving from side to side, stars are positioned and kept in their places. This is the Blessing of YæHúwaH/The Collective that expands and keeps.

The response of the givings of Understanding, from the midst, unto Wisdom stimulates movements and the revelations of all that is in the Crown of Knowledge. The Shayin ו gives the Semek ם as the pillar of Fire that leads by night. The Rayish א gives the Oyin ו whereby all thoughts from the teachings comprise a united, single Eye. The Qúphah/Qoph פ gives the Paúwah פ as a Teacher brings forth Words of Knowledge upon their lips. The Tsade ך, being in the middle gives forth crown branches which bear fruit of all that becomes apparent. The evidence of the gifts given and received is within and upon your branches. **The branching of a Name is the results of the twelve pairs of giving.** According to the free giving, so is the State of Kenoni/Canaan prosperous. From the giving of the Tsade, the twelve pairs of two sides would spring forth from the trunk of the Kephúw and form the Menurahh/menorah to reveal the complete Light in the Neúwn Seed. From their unified sides, all of HhaALhchim beheld the pattern of the Taúwah ח within them that stretches according to their formations from corner to corner, thereby always keeping the dwellings of Soul according to the Orders of Light depicted in the cube—the city foursquare.



**The nature of giving is according to activities of Light—endless giving.** *Those who give all are of the heart of Bayinah.* Giving leads unto all paths of Light and eternal Lives. Your best friend is one who gives and shares all that is within their Name. As Avrehhem is the Friend/Chavar of AL, so are all who give the full measurement of their Name unto the Order of the Lights. The giving of Avrehhem brings forth a new generation of thought, a state of Liberty, whereby nothing is ever bound or enslaved. This generation is according to the giving nature of Avrehhem which affirms their belonging to the Aurim/Lights.

Hence, from this day forward the throat of the Neúwn, which is the cap on the well, as the neck of the body, would always be open to the Teachers who serve there. Nothing would be placed at its neck to hinder the vibrations of thought which are emitted from the inner Assembly of Voices. The Neúwn, with a ten base of the Hhúwa א, is the Head upon which no flesh attaches. That which comes out of the Neúwn נ, as words, do not wear mortal attire.

As we look within the Stone of the Ages, HaTsur/The Rock, we see the Principle of 9, the Number of Truth which is in the midst of the Yeúwd/Deed of Extension and the Chayit/force to break open by ascensions. **Truth reveals to affirm** that which is within every Form and every Deed. As the sun is able to break open the darkness and reveal all things to belong to Unity, so it is, according to Truth, ***The Gold of Wisdom breaks open the darkness and reveals all***, so that nothing is hidden to the Eyes. Coming from the Midst, the sides of Darkness and Light generate offspring of the NeúwnNeúwn/14/5, whereby there appears Yahushúo Bann NUN נננ. Why does 9 appear in the midst of the Rock and also in the midst of the Yeúwd and the Chayit? What is True as NiNe is within that which breaks open and thereby reveals Light. Is a lie true? A lie is not open which closes the eye upon itself. May a lie be extended? It may seem that it can run upon the tongue, but the lie itself has no means to go further than what is falsified. Rather, the lie will set a trap for itself and catch the one to told it. Likewise, the flesh of mortality hides and covers itself with veils of darkness being separate from its pair. The flesh cannot be extended beyond its denial of the Neúwn from which it appears whereby it perishes.

The Days of Núwach/ננ are extensions of the Neúwn unto the Chayit. As pairs brings forth all within their Names, the Light within them breaks open, which is the coming of the offspring/sun of Neúwn, becoming evident. The activities/days of Núwach bring forth the full expression/faces in the Neúwn. Days of Noah are planting a vineyard and drinking the wine; but the wine that Núwach drinks is the wine of the heart and not the forbidden wine of the vine that turns the mind to pursue flesh; the wine of the heart turns the outward nature toward the inner. To say there are 8 Soul of Núwach means that the Chayit rises from the Neúwn. The Neúwn breaks open SEED to reveal the inner Nature of Light into the Chayit, whereby the Chayit becomes the window of Soul. What does it mean that 8 souls are saved by Mæyim/waters? When the Faces of the Eight, that have been opened, come to the Mæyim, they mirror the Neúwn from whence they came; and hence, they are saved from their sides, healing their separation. Space between the two are bridged and forever connected. When pairs turn their back from another, they create a distance; however, when pairs turns their faces toward each other, they create oneness of Yehu. As with all things, we are saved from our destitution when we become faces to faces as One House. Likewise, fruit is saved from destruction as it returns all that is revealed unto the Principle Seed and unto the One who sows it. If it returns not to bless the one who gave it, then it perishes in the field. If Seed is not given, then it remains veiled and lifeless, having yet to bring forth the full expression contained therein.

Soul faces are the expressions of Breaths which will return to the Light from which they have been sent forth; otherwise the faces remain in outer darkness, asleep as veiled, wherein they remain secure until Soul bends toward the inner Light of Faces from which they come.

The nakedness of Núwach/Noah is not to be interpreted as vain or being under the influence of the natural wine; rather the Name ascended in putting on garments of Wisdom and Knowledge. Whereas those who are naked and do not know it, are counseled to buy white transparent garments to cloth themselves. The nakedness of soul is a result of not returning the gifts of the South to the North, via which all that is revealed becomes clothed. The oylah/ascendant offering is an unveiling of all that is being drawn out of the North. The finalization of the offering achieves a garment as the entire sum in the House of Laúwi are presented upon the altar of ascension, whereby a new house is formed for the emerging thoughts.

The giving of the 8 ascendant Soul are what is known as **the days of Núwach**. Núwach/𐤍𐤅 is the giving of the Neúwn/𐤅 unto the Chayit/𐤇 and then the return of the Chayit unto the Neúwn. The giving of the Neúwn unto the Chayit is bringing forth the 8 ascendant force of Soul. The giving reveals all within the Neúwn whereby the Neúwn is naked. The return of the Chayit 𐤇 to the Neúwn 𐤅 is depicted in the garment provided by Shem and Yapheth. As the Neúwn gives, it extends the base/foundation of Wisdom to rise unto Knowledge. The Union of the base/Shem and the Head of Knowledge/Yapheth yields the garments of Light. As the flax is given/sown of the Neúwn, it becomes rooted and harvested into white satin threads. Garments

are received via drinking of the wine that flows from the breaking open of the Neúwn. Núwach reveals—is uncovered as nakedness to reveal all within. The covering of the Name/Shem and Yapheth/openings are the garments generated by the works of Wisdom/Shem and Knowledge/Yapheth. The Seed planted by the Name of Núwach becomes a harvest of spun garments via Shem and Yapheth.

### The Squares of Nines— Verification of Truth is in the Garments

4 𐤅 𐤇 𐤇 𐤅 𐤇 𐤅

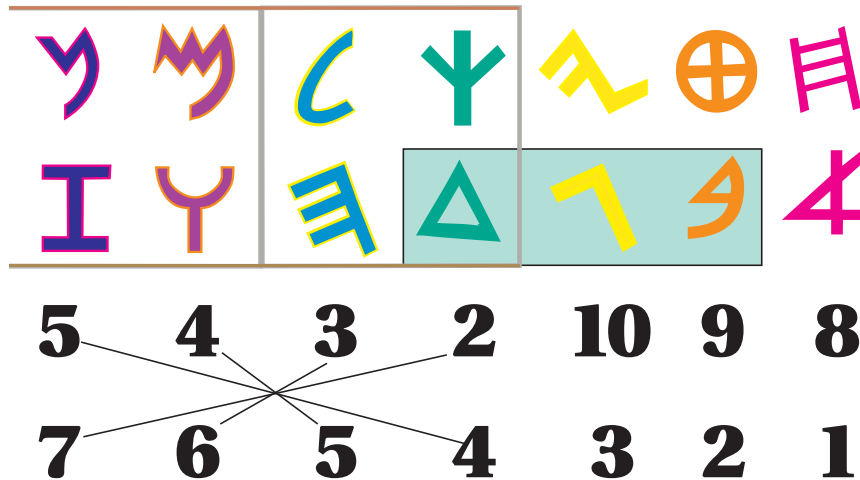

The Letters of the Rock are translated into Numbers to denote their values to formulate the garments of Light. **The Union of the Numbers in the Rock, from their paraments to the inner Letters each comprise the value of 9:** 5/Neúwn + 4/Dallath; Zayin/7 + Kephúw/11/2; Mæyim/13/4 + Ha/5; and ÚWah/6 + Lammæd/12/3.

We learn in discourses of Dan, there are 9 ⊕ basic garment types. These garments are derived from HaTsur/The Rock which is a House of United 9's. The nine garments emerge

and become woven from Letters of the Neúwn ם and the Zayin ז as they are extended into the 8 פ —for Seed Ascension. We may speak of the eight Letters of The Rock/HaTsur as the rods of four faces, for as the Letters are joined together, they form four rods with the value of 9/Tæyth/⊕ in which are 4 faces.

The value of 9/Tæyth/⊕ pertains to the 9 garments which are only woven as four faces of Light comprise the Taúwah × —a totality. Two rods of Light, as they join, express totality, and according to their faces/flowering so are the garments. Cotton comes from the faces/flowering of the cotton plant; linen from the flowering of the flax. Likewise, the garments of four faces is woven only from Unified Faces of Light. Each Name is extended according to the branching of thought which is determined B'Churab (in Horeb). B'Churab all Names and thoughts of Light are brought forth by paired associations. A single Name is unable to generate a garment of Light as the days of Núwach affirm, for each garment has a base of Shem/Wisdom and the means to unfurl and spin the unified thought via Yapheth/the openings/gates. The word garment is comprised of the sequential Letters of Bayit, GammAL and Dallath/Δ^9, which value is 9. A garment/Δ^9 is received through giving, and thereby disclosing, all within. Thus, in the stages of progression of Adim, Núwach, and Avrehhem; these *Assembly of Lights, called by Name*, receive their garments following their nakedness. A garment of 9 is the verification of perfect Union which yields a clean garment of Light, often referred to a white garment, since it is of the Light. However, when the deeds are divisive, the garment is spotted, stained, torn, etc.

### The House of Twelves—The Four 3's in The Rock: The Centres for Branching

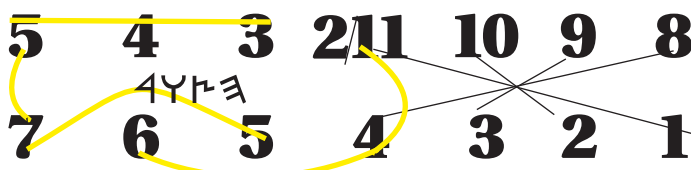

Out of the Rock comes honey/W9Δ/27/9 and oil/ׁׁׁW/48/12/3. From the fields, which are the extension of the core Rock, comes the fruit/ׁׁׁׁX/66/12/3 [Mishneh Túwrah 32:13]. The Houses of 9 and the Houses of 12/3 comprise the Unified Habitation of the 12 Houses of Thought built upon the Rock. This dwelling is known as the Mishkan/14/ׁ which has its origin in the Neúwn. The Rock is the solidarity of Light, being Nine to the .5 (one-half) power, which is three, from which the three Houses of Wisdom, Understanding, and Knowledge are derived. The power of 12/3 is within the House of Nines.

As the branches of Primordial Principles within the Rock are given into the right or South, the Residence of the Lights forms four 12's in which the Light Dwells. The four twelves is a reference to squaring the 12 members as when pairs arrange and square the twelve parts of the offering to the corners of the altar. These four sets of 12 convey that the Light dwells within the Branchings of SEEDHead as it is squared upon the base of Wisdom. Four 12's comprise the 48 cities of Enlightenment appointed for the House of Aharúwan/Aaron. These cities are located within the twelve camps of YishARAL. Out of the House of 9's comes the House of 12's. Twelve + Nine formulate the value of 21, whereby the Shayin/W or Fire of the combined states of Understanding and Wisdom appear in Knowledge. The appearance of the 21 is the Fire and the Glory that arises from the House of 12/3: Wisdom, Understanding and Knowledge.

**Out of the Rock comes the Ten Sayings.** The first five sayings are States of Liberty according to the Nature of all Names. In that all Names are formless as YæHúwaH, the statements convey the freedom from being bound to any form and the Intelligence to maintain the freedom. These first five sayings are spoken by the Neúwn/14/5. Through the initial five sayings all restrictions, forms, and enslavements are invalidated forever. The Nature of the Formless Light is affirmed. The second five sayings are spoken of from the Hhúwa within the Tsur which are the support of the first five. These sayings pertain to our expressions and relationships with all in the Union of the Lights. There is no murder—no cessation nor silencing of any part or member within us. There is no deception or enticement into forms or thoughts of one member to another. There is no need to steal or rob from one part, for all things belong to us collectively and are without partiality. There is no lie to be told, nor hiding one part from another, for all members are face to face within the four square at all times. There is no desire nor envy of another in that we comprehend that the collectively of all parts are One; each part has gifts to comprise the wholeness of a Name. Thus we desire not that any member should be incomplete, for it would mar the wholeness. Should any one member be deprived, then the whole shall suffer and the head becomes wounded. As a unified Name, we discern fully all that is within our Name and seek for the completeness in all Names to which we belong. The realization of a Name being united is that no member will violate another member nor cause any member within to be enslaved to another part. The eyes will not lead astray another member via lust nor trickery. The tongue will not carry a word to insult another; the ear will not entertain that which will counterattack the interior values; etc. As a united Name one lives according to the Union of their sides and all members walk in liberty according to the formless Nature of YæHúwaH. Within the Ten Sayings/commandments, the 1st and 6th are paired as associated thoughts; the 2nd with 7th, 3rd with 8th, 4th with 9th, and the 5th with the 10th. The Ten Sayings illustrate how the Neúwn branches into the two sides of the luach/tablet .5 + .5 from which comes the luach (calendar) of days, months, and the years.

As the hours/parts of a day and night do not dishonor each other, but are complimentary to comprise a complete act of Light, so are the parts within a Unified Name. Each part, as it is honored and placed upon the mizbaach/altar, upholds the Unified Name to which it belongs. In perfect Unity of all parts/members comes the saying, “Oh, **how good and pleasant** it is for brethren to dwell together in Unity [Tehillah 133:1].”

At the sides of the ark/aruwn are the books of the Law. In The Zayin are the *haMitswut*/commandments. The ÚWah, at its side holds the Words of the *haChuqot*/Statues and the *haMishmeteth*/The Charge. As noted above, in the Hhúwa are *haDevarim*/The Words of the South. The Dallath serves the Neúwn to bring forth the words of the *haMishpatim*/Judgements.

The Neúwn within the Shayin—The Moon within the Sun

The Nature of the Neúwn to branch into the lands of the Kenoni is conveyed in the positioning of the Neúwn within the *Shemesh*/sun. As the foundation of the Eight are laid, and the Rock

begins to spread out, *the value of 21/Shayin appears at the crown of the Neúwn*. The value of the 9 in the North of the Rock and the value of the 12 in the South of the Rock combine to bring forth the Shayin [ $9 + 12 = 21$ ]. The Shayin is the result of the union of the first two rows of Letters via which the Neúwn ascends into the third row. As the glory of the Rock commences to radiate in the Shayin, so properties of thought upon which it is founded, move into lands of Knowledge. In this way, we transfer all of our properties into new states of residence, even into the ten lands. The Neúwn becomes positioned within the radiance of the Shayin even as the moon takes up residence within the glory of the sun. How so? Even as the radiance of our Name breaks forth from within us, so we abide within the showering burst of Lights.

The moon is said to be a mirror image of the sun as the Oyin is in the right, mirroring side of the Shayin. Of the three Letters that have a reductive of .5, the Oyin and the Shayin reside within the Letters of Knowledge. Via numbers, we behold the Presence of the Oyin within the Tsur! In that their are 8 Letters that comprise the Rock, and each Letter of two halves, we behold the 16 parts of the Rock which is summed in the Oyin, the 16th Letter. Via the two halves and the two squares within the Rock, the Nature of ALhchim can multiply all aspects of the Oyin Head. And where else do we see the Oyin? The Presence is upon the faces of each side of the cube, each being comprised of 16 parts. The other two Letters are in the innermost sides of the North, those being the Neúwn and the Zayin. The Zayin is the only letter with the Neúwn in Wisdom, for all else of Wisdom and Knowledge is a gift of the Zayin. The Zayin, being 7, yields the fruit of perfection and beauty.

The Neúwn, symbolized in the moon, gave of itself completely to the *Shemesh/sun*, whereby **all that is within the Neúwn and within the Rock that is laid, become known**. To say that the Neúwn gives all to the Shayin is likened to a tree giving all that is within it to the branches and the glory of the fruit that it bears. Is it not so that a vine will give all that it has to a melon and then wither? The nature of giving all that we are unto another conveys that we are of the Light and in us there is no shadow of reservation to hold back the revelation of every dynamic of Light. For until all is given, all cannot be known. The Neúwn gives itself completely to the Shayin whereby it would draw out all of its parts. Via positioning ourselves within another we are founded to expand and to bring forth all attributes within our Name for the collective of YæHúwaH. As we read the Name, Shayin/שׂא"ו, we see that in the Shayin/W is the extension/giving/שׂ of the Neúwn/א. As we consider the numerical value of the Shayin/שׂא"ו we note the value of  $360^\circ$  in which one sees all that within the Rock. The sum value of the Eight, comprising the Tsur is  $72/9$ . The Neúwn extending into the Shayin carries forth the value of Rock in the number,  $360/9$ . As the Neúwn positions itself within the Shayin, all parts of the moon may now be observed. Thus during the month, the parts of the Neúwn are read as the various parts of the moon become apparent.

The Rock, being of Eight letters has within it 16 parts. These 16 parts convey *the Presence of the Oyin, being the 16th Letter, within the Rock*. The 16th Letter, the Oyin, is to the right of the Neúwn, which conveys that it is *a gift of the North*. The Oyin is the Letter that illustrates the moon. Due to it being in the south side of the Letters, it conveys that it is an extension of the Neúwn. The Faces of the Oyin, being within the Rock, are hidden at first glance. In that all Letters are a drawing out of the Neúwn in which all things are assembled, we behold the full

Nature of ALhhim as 22 with the reductive of 4. The reductive of 4 expresses that all that the full council of ALhhim resides in the Dallath which extends itself into the House of YæHúwaH. In being four, the Body of ALhhim is always face to face and squared, whereby every Principle is positioned with honor without partiality. Thus those who are of the ALhhim of the Lights, are positioned with another in which they are drawn out and their full expression becomes known.

In looking at the bodies of the moon and the sun, we comprehend that the Oyin, depicting the moon, is always within the Shayin. All that is in the Head Oyin, takes its position to be secured within the base—the Foundation of the Lights—in the Shayin. Via positioning the Head unto the base, the Mind is able to draw all things out of their Unity and to behold the assembled sides from every aspect. As the Mind moves to the base, every angle and part is able to know its assembly of sides. To know all that is in the Mind is to behold all that has been given freely. Thus during every hour/part of the day and night, the Mind of Bayinah observes every part of Wisdom and comprehends all that is in Breath. As the moon is distinguished by a unique shape every day and night, we behold the 60/∞ structures of Light. Every day and night the moon depicts the shapes of the seeds which are sown within the ten lands. Even though one may not be able to see the moon every day and night, the shape of the day and night is still present. The invisible states are more after the likeness of ALhhim than the visible, and when the moon is entirely covered, we may see all the more clearly for the two circles of Light are directly upon each other whereby nothing is hid or obscured. Likewise are all who are according to the Nature of ALhhim [Col 1:15].

Thus, the moon is within the sun even as the head is within the foundation. The shape of the buttocks conveys this Principle. The buttocks portrays the moon in all of its phases, from the fullness of the united cheeks with its halves/quarters, to the dark moon of the anus. As the faces of the buttocks are in the base of the body, so are the faces of the moon within the Rock of our Foundation. According to the shape of the moon, we recline upon our seats, rest, and delight in our *shavbethuth/sabbaths*. The projection of the moon body is not the essence of the moon even as the body is not the essence of the Order of Lights within the body. Rather the moon body is a means to reveal itself, being that its essence is within the sun in which it is positioned. In that the Oyin is the 16th Letter, it is comprised of 32/.5 parts which is the same reductive of the Neúwn/14/.5, affirming by Number the Nature of Light/5. The third number within the 22 Letters, which carries the value of 5 is the Zayin, being a composition of 14/.5 parts. Thus the union of the Base of the Zayin/.5 to the Head of the Oyin/.5 affirms the Unity with the Neúwn/14/.5. These three are the authority of the Lights in each level of thought: the Zayin is the .5 of Wisdom; the Neúwn is the .5 of Understanding, and the Oyin is the .5 of Knowledge. Their reductive value is evident that they belong to ONE and that Wisdom and Knowledge are of the Northern Light, for they carry forth the image and likeness of the Invisible Ha/5 which is the ten base of the Neúwn.

Do we need to continue to look in a mirror to behold our faces, or can we come to see all of our parts and expressions of Name from the origin of our being—from the Rock of our Foundation and from the outstretched hand of all that we have given? Have we positioned ourselves in the Tsur so that we can behold all of our parts? If we consider that the One of ALhhim

created Adim in a gendered form of mortality, such as humankind, then we must think that the One of ALhhim is likewise mortal [Sepher MeOShah Bereshith/Gen 5:1; Mishneh Túwrahh/Deut 4:15-16]. **The One of ALhhim is without form, without limitation, without division, without subject to corruption.** The Nature of the One of ALhhim is formless, yet expanding and contracting, unified and immortal. It is the likeness of the One of ALhhim that Adim is formulated via Breath, being a composition of fiery Thoughts—taken from the ashes of the evening and morning offerings of the fifth day—*yom chamishi*—the ability to fit all things together and to compose the garments of Light. The formulations/creations of each day are made by the thought distillations of the preceding olot lambs.

As Bayinah, we position ourselves in the Fire of the Shayin whereby we are secure and no harm, nor disease, nor fear can reside within our fiery Name of Light. We are as the Oovriim/Hebrews who are thrown into the fiery furnace, in which there are no bonds that can tie us nor enslave us, but in which we may walk and proceed as Names of liberty.

### *The Land of the Girgashi Thought Process*

9. The **Girgashi/גִּרְגָשִׁי/Girgashite/a State of Semek**, corresponding to the fourth finger of the left hand. **The Thought Processes of the branches gather into pairs and groups to convey the full strength of ALhhim.** While mortal flesh holds a lower thought to abide unto itself; the Breath seeks to abide in associated Names and within tribal frequencies of Light to which we are appointed amongst the whole House of Names.

#### HaTúwrahh are Teachings of Paired Faces and Their Thoughts

Thoughts of kabbalah stem from the association of pairs in the Girgashi State. The term, kabbalah, is within the scroll of Sepher Yetziat Metsryim/Exodus, and pertains to the curtains of the Temple. The curtains are arranged in pairs, five on one side and five on the other and then united together. **The word, kabbalah, pertains to how every part corresponds to comprise a whole.** Every part is associated with another part, to comprise a pair, whereby there is no strange member in the House of ALOZAR. The foundation of all pairs is the Master Name of ALOZAR being a Name of perfect Unity of two parts. The 22 Fire Hebrew Letters are arranged in sets. The sets of Letters are of the four Heads of Understanding and their sides of thought, the sides being Wisdom. The four Heads of Understanding being the Yeúwd, the Oyin, the Shayin, and the Neúwn. That which comes from the four Heads are their attributes of Unity, which is also to be said, their giving. The giving of Understanding yields the foundation of Wisdom. Each set of Letters are 10, from their base to their Head. The ten Letter of each set are their full extension. The Yeúwd extends to the base of the ALphæh, the Oyin to the base of the Zayin, the Shayin to the base of the Lammæd, and the Neúwn to the base of the Ha. These Heads of Understanding come from the Crowned Head of Light, being ALOZAR. Hence, from the Rayish there becomes evident the Oyin, and from the Lammæd, the Yeúwd, for there is no surrounding consciousness of Light—the Oyin, without the unwinding of the Rayish. There are no deeds—the Yeúwd, without first establishing the feet—the Lammæd in a path of progressions; otherwise the hands will tumble that which is within them without an aim of transfer-

ence, for all deeds/works are the means to transform energy into another State, as Yishshakkar is knitted to Maneshayh. Thus, we see that there are two primary Heads of Understanding, the Neúwn and the Lammæd, and two transference Heads of Understanding, the Yeúwd and the Oyin. In the arrangement of the Letters and the placement of the Heads, Bayinah places Understanding in the midst of all the Letters as they are extended, even as Bayinah/the moon, is positioned within the midst of Chækúwmah/the sun.

### The 8 Heads and the Pairs of Numbers/Letters

Eight Heads are activations of the Mind. As the 8 Heads are activated within the Mind, the Name of Light puts on the 8 Heads which regulate the 4 bodies/sides. In some reference this may be stated to be the putting on the Mind of Mashiyach. The term, Mashiyach/Messiah /משיח, is comprised of 4 Letters. The meaning of Mashiyach pertains to an extraction that causes the flow/anointing of Wisdom and Understanding of 8/Eternal Life, or the drawing out of the Fire to achieve the 8/Chayit Mind whereby one is measured or anointed. The full measurement of a Name comes by bringing forth the entire body of the 4 sides.



Tæyth which takes its place in Knowledge, as the Paúwah, at the left hand of the Oyin.

The 8 Heads are pairs which comprise 4 sets. Each set has a face to comprise the four faces or 4 mouths of ALOZAR. Each set is a construct of 10 Letters. From this arrangement, comes forth the tithes into the House of YahuWah, for the tithes are of the sets of 10 which fill the House/Body of Light even as the Mind fills the body and causes it to overflow/run. The body of the 8 is the Temple—Lamp of the Shayh Lamb. The 8 Heads open the Mind unto the 4 faces/mouths via which the pattern of the United Teraysarun of 4 sides is communicated, each side being a face. Thus the term face is always faces, plural, denoting the Unity of the 4 Faces within the Letter



In that every Name has all attributes of the ALhhim of ALOZAR, being birthed of LIGHT, the Unity of Names is perfect, for every Name has corresponding attributes whereby they are perfectly united in every part. In like manner, each Name has twelve branches/tribes yet belongs to one lineage; therefore all Names know their respective place in Light and has honor for every Name and their position in the Tree of Lives/Menurahh. The basic meaning of the term, Menurahh, is Nerah, meaning a lamp. As one knows their place within the House of Yahuwah, they comprise the Lamp of the Lamb. According to kabbalah thought—thoughts of associa-



tion/pairing—the Lamb is the Rayish Mind of Pairs whereby all that is of division is overthrown.

Regarding the Heads of Understanding:

**The Yeúwd/Hand/Activity** is of the ALphæh, for when a Principle becomes extended, then the work of that Principle is in the Hand. Hence, all works of ALhhim are based on a Principle Seed/ALphæh being extended within the Hand/Yeúwd. When the ALphæh is in the eyes, then the Principle is extended to the right hand and implemented. Thus, Yahushúo said, upon seeing The Principal work, the inner will of my Name works likewise.

**The Oyin** is the Head of the Zayin which is the means to sow the ALphæh. As seed are sown the by Zayin, the results rise in the Head of the Oyin. The values of the Head and the base are the same: the ALphæh/1 and the Yeúwd/10/1 are both ones; the Zayin/7 and the Oyin/16/7 are both values are 7.

**The Shayin** is the Head of the Lammæd as the Fiery Radiance is the result of the crown of the Lammæd Staff being polished. The manner in which one walks is the path that regulates their activities and the State of their illumination. The throne of Wisdom is seated beneath to rise as the Crown. Harmony of Numbers appear; both Lammæd/12/3 and Shayin/21/3 are 3's.

**The Neúwn** is the Head of the Ha, stemming from the foundation of the Breath. When the Breath is extended it fills the Mishkan; thus, via the Neúwn, all things are extended with all attributes of the Light. When there is an extension of thought, the Neúwn brings the Breath into the space of the thought and occupies it whereby no strange thought can reside there. In this manner each space becomes designated by a Name. The Hhúwa base/foundation is formed by paired Names, as HaWahHa, and then extended to the Head of the Neúwn which comes to rest upon all of its sides. The congruent Numbers of the Neúwn/14/5 and Ha/5 both contain the value of 5. In that the base and the Head are of the same Number, they are one body of thought within the House of ALOZAR.

The **Neúwn** is the throat of the Oyin Body from whence comes word forms which extend the Mind and creates all things. The opening of Words gives Light; thus from the Neúwn comes all Lights. *The path of the Lights extends from the Neúwn* like a serpent through the Letters: the Neúwn extends to the Zayin, then from the Zayin to the ALphæh, from the ALphæh the Neúwn rises into the Yeúwd as the 10th power, and from the Zayin the Neúwn rises unto the Oyin. With the strength of the Oyin/16/7, the Neúwn extends unto the Shayin to bring forth the full glory/radiance and *Shekinah*/אֲרָצָה resident which inhabits the House of Names as a Master all States and levels of thought. The Neúwn therefore creates and then fills and comes to take its seat as the Master of the Letters amongst its united members bringing forth the fourth Head of Understanding whereby the four faces appear which are the *damuth*/likeness HaALhhim. The state of Mastery of the Neúwn is the land/state of the Yevusi.

The Neúwn is the Head of the Teraysarun—the extended Mind that ascends from the midst. In each sequence of bringing forth the 4 Heads of Understanding, there are the unfolding works of grace and the supportive Heads of Wisdom. In the Neúwn is the invisible Nature of Life, as the very center of a seed that takes root in the Zayin and then branches forth to bring forth its radiant Head depicted by the showering radiance of the Shayin that resides upon the Neúwn. Amongst all of the Heads of Wisdom and Understanding, the Neúwn does not succumb to be robed by flesh or to be sit upon by the harlot that sits on the other seven heads, for it reserves itself to be clothed by the fine garments of the Light alone, which is its immortal Nature, even as all that comes from the throat is invisible, being formulations of thought, therefore not of flesh nor does it seek an appearance or reputation among the carnal/corruptible. The Neúwn is the most inner Head of Understanding in the North, as that which is in the midst of all things, as the nuclei, and is the gate into the nuclei—unto the Paired Names of ALOZAR. The Neúwn is comprised of 28 parts or fourteen halves, arranged in two sets according to the Mind of ALOZAR. *By Parts* the Neúwn are  $28/\gamma + 12/\Upsilon + 28/\gamma = \text{ÆO}/68/14$  which conveys the Presence of the Oyin/O consciousness with the grace of Wisdom/Æ always present and active within the Neúwn. As the Neúwn gives of its consciousness of 16 parts (being the Oyin) to bring forth the Chayit; it establishes the left parameter of the Letters:  $68-16=42$ . Within the Neúwn is the House of Laúwi depicted by the value of  $28/\text{Æ}\Upsilon$  revealing the position of the Laúwim in the midst of ALOZAR, as the branches/ $\Upsilon$  of the Rock/Æ. As the House of Leuwi are within the Rock, the tribes of YishARAL are the branching of that which flows from the Rock/12. The House of Laúwi/ $\text{Æ}\Upsilon\Upsilon/28$ , being of the Rock, flows with the waters coming out of the Rock whereby they appear with the House of YishARAL/ $\Upsilon\text{Æ}\text{W}\text{Æ}/64$  or 128 parts. The reductive value within the Neúwn display the position of the 14/5—Eternal Life.

The four Heads are united in the consciousness the Oyin Head. The reductive value of the Heads are: Yeúwd/1, the Oyin/7, the Shayin/3, and the Neúwn/5; added together they comprise the collective Oyin/16. Within the Mind of the OyinZayin Body the Heads reside. From these four heads come the four faces of the *damuth*/the likeness of ALhhim. The Yeúwd is the face of the Ox/ALphæh; the Oyin is the face of the Eagle; the Shayin is the face of the Lion; and the Neúwn is the face of Adim [Yechezqel/Ezek 1:10]. Together, the four Heads comprise two Rocks united: the Yeúwd and Oyin,  $1+7=8$ ; and the Shayin and the Neúwn:  $3+5=8$ . The value of 8 is associated with the number of Letters in the Rock and the sum of the collective Name of YæHúwaH/26/8. Each Name has at its base HaTsur/8, the properties of the Shayh/26/8. The Union of two bases of Shem/Name yield the Oyin Sheath or garment of consciousness:  $8+8=16$ /Oyin. The value of the Rock: 4 stones of Wisdom and 4 stones of Understanding, being 8, comprise the Body of the Heads, as there are 8 Letters that form the body of each Head of Understanding. Within the ALphæh to the Yeúwd are the 8 Letters of the Bayit to the Tæyth; within the Zayin to the Oyin are the 8 Letters of the Chayit to Semek, etc.

As Signs of Wisdom are the base of Understanding, so Heads of Wisdom take their seat as the base of the Heads of Understanding. The ALphæh, being the Head of Wisdom/RAúwaben, is the base of the Yeúwd. The Ha, being the Head of Wisdom/Dan, is the base of the Neúwn extended; the Dallath, being the Head of Wisdom/Yahúdah, is the base of the Neúwn within the Tsur. The Zayin, being the Tongue of Wisdom/Aparryim, is the base of the Oyin, leading to all Knowledge. The Lammæd, being the scepter/rod of Understanding, being the foundation of

Light/Ha, becomes the the base of the Shayin/Knowledge in which Understanding dwells. The Lammæd resides in the Fire of the Shayin, and according to this extension, all 12/Lammæd disciplined camps are brought into the Fire and are forever the *olot*/ascendant perpetual offerings to YæHúwaH. In the Lammæd the ALphæh Seed is fully extended as the Rod of Instruction, for from every Principle ALphæh arises the Lammæd Rod of Instruction. The Seed Word generates the Staff/Lammæd/30 of the living expression, animations and movements of the Lights for each month of 30 days, being a cycle of Understanding.

In formulating the four Heads and their bodies, Understanding extends in 4 directions via which all things are encompassed. Via the extension, Understanding builds the House of YæHúwaH that is full of Wisdom and Knowledge. **Through the Heads, one presents their tithes into the House of YæHúwaH, whereby the blessings of the tithes fill their four sides/bodies/houses to overflow with all good things/words.**

As we hear the Voice of ALOZAR we lay the foundation of Wisdom by joining the Teraysarun base of united squares and then draw up the Heads. In drawing up the Heads we establish the full extension of Thought as occurs in the oylah offering as the hands are placed upon the head. What are the deeds of Light? What are the words of Light? What is the glory of Light? And what are the lands of Light? As one begins to draw out the Heads from the base, they move from being a sojourner unto being a resident of the Lights.

As the Heads are brought up from within the members, one may see the Lammæd being the guiding staff, for as the instruction rises in brightness, so are the Heads taken higher until one sees the Lammæd amidst the Rayish and Oyin. The Lammæd, being twelve, occupies the space amidst 20 and 16/7:  $4/20$   $\zeta/12$   $\circ/16/7$  whereby the Thoughts are according to the Mind of ALOZAR. For the paths and the thoughts in YæHúwaH are not as mortal nor can they be reduced to the realm of mortals, but by them one is raised into the Names and realms of Light [Yeshoyahu/Is 55:6-9].

In the eight Letters of the Rock, the Neúwn extends unto the doubling of the Dallath. The Dallath/4, when extended by 10, becomes 40—the value via which the Name of Aharúwan emanates from the Rock as the servant of ALOZAR. In that the priest embodies in Mind the full extension/10 of the Teraysarun base of 4, thereby being 40, the priest appears as the hand/Yeúwd of the King. The position of the Hand affirms the position of the House of Laúwi in the midst of the AL— $\zeta^{\text{v}}$   $\text{v}$ . As two Dallath/Teraysaruns are united, they form 6 sides, the cube. In the house of united Names there are the four outer walls and the two inner walls of strength via which the two Teraysaruns are joined/woven together. The the value of the double Dallath is  $4+4=8$  plus the 6 sides comprise the value of 14 as is the Neúwn/14.

The 22 sets of Numbers are in the midst of the Letters, each set of Numbers is a Union of Principles to comprise a whole., There are no half Numbers or partial values—all Numbers are whole values and each Number is a set: i.e. ALphæh is a set of  $.5+.5$ , and Bayit is a set  $1+1$ . The sets arise out of the North—out of the centre which is the hidden side within the Mind. Thus the Union of Numbers within the Rock extend into pairs: Neúwn is extended into the

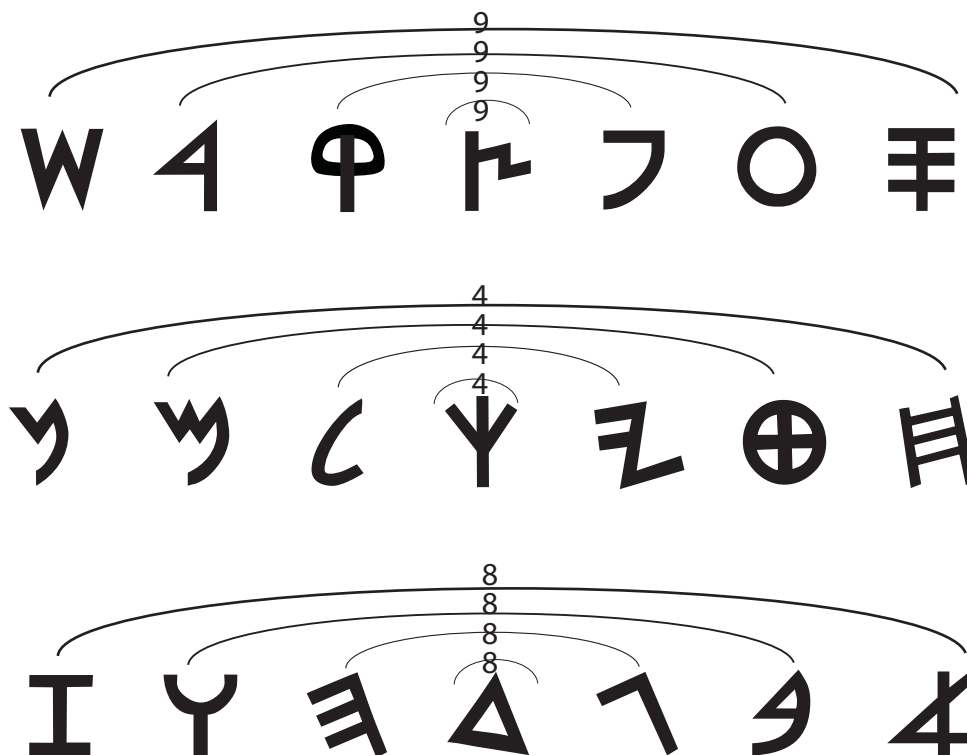

## The 12 Pairs of ALhhim (Elohim)

The four 8's, four 4's, and four 9's

*comprising the 12 Houses of Thought*

## The 21 Principles of Fire

The Unity of  $8 + 4 + 9 = 21$

*through and in which the Taúwah/X of Totality appears*

Chayit, Mæyim into the Tæyth, the Lammæd into the Yeúwd, and the Twins of the Kephúw, being AL and AR, and those that are of this Union. We may see the pairs at three levels: 1) the pairs within the Centre include the foundational structure of Bayinah and Chækúwmah, comprised of the 8 Primary Letters of haTsur. The Neúwn, Mæyim, Lammæd, and Kephúw are the Letters of Bayinah, and Zayin, ÚWah, Ha, and Dallath being the Letters of Chækúwmah, 2) the pairs as they are extended from sided to side: i.e. from the Neúwn to the Chayit, from the Zayin to the ALphæh, etc., and 3) the pairs as they branch forth to reveal the glory of their Union: i.e. from the Neúwn to the Shayin and from the Chayit to the Semek. Within and surrounding these three levels of pairs is the United Consciousness unto which they belong, which is within and yet surrounds. The later is referred to as the Breadth of a Name. Hence, in the analysis of pairs we comprehend the center from which is the width, the depth, the height and the breadth of all Words/Names, being the composed thoughts of ALOZAR.

The 22 Fire Letters are The ALhhim of ALOZAR

Combination of Numbers within **the 12 Pairs of ALhhim** are comprised of four 9's (36), the four 4's (16) and the four 8's (32) which, in being joined together, yield a value of 84/Δ7. The Letter Paúwah/80/7 depicts the faces and mouths of the collective ALhhim. The mouths or openings appear when the parts are assembled. Though there is an appearance or an expression, the faces are only of their collectivity and not the faces of any single part, for no part will be seen apart from another nor desire to do so. The Paúwah forms the mouths which are seen on the four sides of the body: the mouth of the neck, the mouth of the left and right arm pits, and the mouth of the loins. The four faces are the expressions of the united *damuth*/joined likenesses of ALhhim as the faces of the ox/United Principles, the faces of the lion/Wisdom/Radiance, the faces of the eagle/Understanding/Transformation and the faces of Adim/Giving Emanations. There are the four mouths of the month being the four *shavbethuth* through which the four heads of Wisdom and the four heads of Understanding speak. These are the faces of the Invisible ALhhim, for the only manner in which ALhhim are seen are in a collective state, not individually, and if seen separate from the others, they are estranged from the whole.

The value of 84, which is the expression of the Teraysarun, is comprised of the four sets of 22 within the House of Understanding. From the midst of our Assembly comes forth the four mouths or the Sayings/7 of the Teraysarun/Δ. Via the mouth/haPaúwah, the seeds are open. The opening of the Seed creates light, wave and frequency whereby the thought within the seed begins to set forth a root and branch. These Lights, opened by the Mouth of the Rayish/AR, are known as Bayinah and Chækúwmah, the moon and the sun. The stars branch forth from this Union of Light. According to the Mouth of the Rayish, Knowledge is upon the lips. Out of the Lights come all Names, and out of the collective and unified Names come forth the faces/expressions of Light.

Túwrahh Kabbalistic/Symmetry Thought identifies pairs and unite them into ONE. Each pair is comprehended to have come from the Mind of ALOZAR (Elozar), including the pairs of Letter, Numbers and Names. In determining via Dan how all things are to be united into a whole, we comprehend the vast Mind of ALOZAR. In Kabbalistic thought we consider the unity of all things and how all things correspond to the Nature of ALhhim whereby we know the Attributes of ALhhim and Works of ALhhim. Through Sod thought, we enter into the parts that comprise all things to unveil the mysteries within every assembly of thought. One may see the sun, but what parts are within whereby the sun maintains its collectivity and position amongst the Lights? Access into the parts enables one to go into the depths of the Mind of ALhhim to know the structure within every Seed, and in so knowing the parts, the foundation, the extension and the glory are understood. When one knows what lies within every seed, then the roots that come from the center, the trunk, and the system of branching that brings forth the flower and its fruit are understood, and being understood will be honored above disorder and beyond violation/transgression to the will of YæHúwaH. In essence, Kabbalistic thought leads to the universal salvation of all Names and the kingdoms to which they are appointed. As all things are perfected in the Mind of ALOZAR, likewise, they are perfected and joined together into all that is expanding from the Mind of ALOZAR. As we couple Sod thought with Gamarrah Thought, we study how all Seed words are unfolded unto the glory of all that is within ALhhim. The State of Sodom and Gamarrah are means to discern how all things are one in the Garden of YæHúwaH where Avrehhem— expansion of Seed reside and flourishes.

## Service is Love—the Bond of Perfect Unity

The sayings of the Ten Words are set forth in pairs as all words stem from one word, ahhav/love, being the composition of the HaWahHhúwa Principle. In using the Cardinal Numbers of Thought, the word *ahhav* is perfectly balanced. The word *ahhav/love/אחא* is comprised of three Letters: the ALphæh, the Ha, and the Bayit. The ALphæh is of two parts which is of the oneness of the Ha/Light, being of two parts of Ha/.5, each Alpeh has ten parts/10 which reduces to 1. The ALphæh is displayed in the Bayit, the house of pairs. The formula of *Ahhav/Love* is 2-1-2, or **two are one**. Love is based on 4/ALphæh, 2 parts of light—HaWahHa—.5+.5. ALphæh is the means to extend unto 10 parts or the Yeúwd, which is the head of the ALphæh. The Yeúwd, as the Head of the ALphæh, is within the ALphæh as .5 + .5 = .10/1 just as the head of a plant is within the seed and within the plant even before it forms. The full extension of ALphæh, being One, is a Single bond of Light. This single stand of Light, being of two parts or two ends, comprises a 2/Bayit—2. The Bayit is the House of the Yeúwd/10 which is comprised of the underlying ALphæh/Seed—the HaWahHa/אחא, when extended/א, the Name of אחאא /YæHúwaH appears. The bonds of light are in the midst of the pairs of Names which comprise one house. Being joined as two sticks of Light, **the mutual state of Unity does not violate itself for it is the state of Ahhav/love**. The Union of Pairs are founded and fully extended via love, and upon Love the House of YahuWah is built/woven. When love is perfected amongst the parts/pairs, there is no corruption, for the pairs have built an assembly of parts, called the House of YæHúwaH, which is immortal. Love has no end nor perishes [I Cor 13].

All pairs become evident through the Lamb that is slain and thereby opened prior to the foundation of the world. Until the Shayh Lamb is opened, all remains concealed. Thus there is no world constructed until the Shayh Lamb is opened, being said to be slain from the foundation of the world. The Shayh/אחא comprises the value of 26, the collective value of YæHúwaH, in which are the thirteen pairs of Knowing.

The way that the New World is built is by the opening of the Shayh Lamb wherein lies the incorruptible paired thoughts. Upon these pairs we lay the foundation of the House of YæHúwaH for an incorruptible world. In like manner we lay the pairs of the oylah offering upon the pairs of branches upon the altar out of which comes a new state of residence for the day. The bringing forth of the paired branches of Thought are depicted in the boards of Lebanon which are the structure of the House of YæHúwaH. The Cedars of Lebanon are the branches of the Tribes, being the branches of Mind's enlightenment/*lavanah*.

The branching of the Tree of Lives is a fiery Tree of Lives itself! When maShayh/Moses sees the burning bush within the united members of one's body, the entire plan of the Mishkan is laid. Beholding the State of Gírgashi—the State of Pairs causes maShayh to come forth with the illumination. The emergence of a Name is ignited by the consciousness of the United Pairs within, and in this awareness one comes out of the subconscious and denies the grip of Metsryim upon their Name. The fear and threats of Metsryim/Egypt, and the fear of mortality

can faced straight-on because the strength of the Fire within the United Branches has been perceived/understood. When you see yourself as the fiery bush then you connect to the level of the nature of your immortality. This State becomes your reference point whereby you are no longer seeing other people as mortal because you are seeing the fiery bush within them and you are connecting at the fiery Nature of their branches.

The Pairs of Names are of the position of FIRE that enable our Thoughts to be composed and expressed. Each pair enables a concept of Fire to spark and expand. According to our thoughts we designate the inner spaces of the Mishkan.

We are Thoughts and dwell in the branches of our Thoughts. *At the very centre of our Name, as from the Centre of ALOZAR, we start to spin out and thereby create a habitation of seven-fold, being of seven/complete levels within a spiraling of Ten—the full extension of unified circles.* Each of our thoughts, when full extended from their unified base, are layered and white as the rings of an onion, which are ten. These ten circles comprise the Oyin/O consciousness. The Oyin is the extended Mind. Within the Oyin circles are the orders of Life! The dwelling State of our Names is The Mishkan, being a collective House of Names. The Thoughts of our Name have roots, a trunk and associations of Branches. Each Name is appointed within the Ten Circles of ALOZAR, and each abides within the level as they are called/Named. Some span all levels and while others abide within the roots of the Rock. Via the emanation of our fiery Names we create spaces. These spaces are the spirals of thoughts. The emanations of Light are through Words. Via the words of Knowledge we carry forth the illumination coming from the inner FIRE. Thus everything of the Mishkan, being the branching of Mind, is of Fire. All stems from Fire and all operates according to Fire. The Fire radiates through our branches as the burning bush. We draw out the Fiery Faces/ך from the base of the GammAL/ג, the fiery foundation, into writings/ג and unto sayings/ך; in so doing we bring forth the State of the Mishkan in which the pairs of Names are evident to build the House of YæHúwaH.

Girgashi is a compound word comprised of two words. The first word is Hagar/גאג, meaning to sojourn or to dwell or to reside. The Ha/ג prefix indicates an enlightenment of the sojourner who dwells or resides in the illumination of associations. In particular, the enlightenment of the sojourner pertains to the mass or the clumps of properties or what is dense in manifestation, from the root גאג. **A manifestation is a disclosure of all parts** and does not necessitate a mortal form or an object, as the manifestation can beheld in a vision of assembled Principles. If the parts assembled be of the Light, then the form itself is incorruptible as the parts that comprise it. The enlightenment into the compact state of properties or into the groups assembled is a result of the Kenoni State of occupation, *for out of the branching of Mind comes associated pairs.*

The basis of all branching is humility whereby one gives all, and as a result, one brings forth the complete inner pattern. Via the humility of maShayh, the complete pattern of the Haikal/Temple is made known. The humility and submission to the entire design brings forth the whole House of YæHúwaH which is *a dwelling/residence of paired thoughts with an illumination of the compacted groups amassed together.* Such describes the clustering of Names into manifested blocks or groups. The state of Girgashi is abiding in a clustering or blocks of

Names that comprise the House of YæHúwaH, depicted as pairs of fruit hanging together upon the branches.

Without the submission entirely of all parts to be ONE, there is inner conflict and restriction to revelation. One must come to the state of wholeness of mind that there is nothing within oneself Name's extension that will violate any part or member within. Likewise, as two Names are joined together, there is such a unity that one Name will not violate another Name, but together they will prove that Union of the Lights. *This state of equality and unity is the fruit of Dan within us—Shucham.* As two give all parts to become a group/cluster of Lights, they enter into the Girgashi Thought and the lands of liberty via their Union. No one will receive an immortal body without demonstrating the wholeness of their Name and the wholeness of their Name joined with another to bring forth the full revelation of YæHúwaH.

ALozAR (Elozar) is the only king, and ALOZAR is the only teacher, because all rule and all instruction come from the loins and mind of ALOZAR. If the rulership is of Light then it is the rule and the only rule of ALOZAR, and if the instructions are of Light then the teachings are of ALOZAR. Therefore, all mastery/kingly and all priestly functions stem out of the Most Blessed of All Names.

When YishARAL ask for a king as other nations, it conveys that the consciousness of ALOZAR has yet to arise within them; for kings of other nations are those which usurp authority over people. The kings of YishARAL are the authority of a Name arising to undergird a people [Sepher MeOShah Bereshith 17:6]. Why is it that ShmúwAL (Samuel) is the one to appoint the kings and that the first King comes out of B'Niyman? What does it mean that ShmúwAL causes the anointing to flow upon the Head of B'Niyman? The first head, Shaul, comes from the inner most part of the Seed. The second head of the kings, being Daúwid, comes from the root. The third head of the kings, being Yididyah/Solomon comes from the upper branches. As the branches come from two sides of the tree, so kings of the northern and southern kingdoms rise from a root Name/ΔΥΔ/DæuwD/David.

The phrase, “the King of Kings,” denotes collectively of your Name achieving mastery in your 12 Houses. You rule over and have mastery of all authorities in your dominion. As you are of One Collectively, all powers outside are subjected unto your Names; however, when divided, one falls to weakest of powers. Even a slight suggestion or visual impulse and/or a leavened thought can overthrow the entire house when members are not united and stand together as One, being positioned upon HATSUR/the ROCK.

With illumination comes strength. When the illumination occupies your houses as the most cherished guest then the Light rules within you. This is what is meant by the KING-PRIEST. The Illumination comes out of the North and fills your chambers of the South; in so doing, all nations--processes of thought are governed according to the Illumination of Governing Hands.

4IOŁ4—the King-Priest Twin Name of Light

**ALozAR is a paired Name, a King and a Priest,** referred to by the compound Name of



Malekkiytsedek/Melchizedek, signifying the Rule (Melek) of the Moon and the Righteousness (Tsedek) of the Sun, unto whom Avrehhem gives wealth/tithes. The Ten of your Name expands in Avrehhem and transfers into a Rule with Illumination. ALOZAR is a twin Name, being the Source of the Tree of Lives/Υ, the Kephúw, from which comes two sides of Understanding and Wisdom. [References to ALOzar: The AL of Wisdom, The Help/The AL of Understanding. I Sepher Melachim/I Kings 3:28, Dibre HaYamim ALphæh/I Chr 22:12, I Cor 2:7, Dibre HaYamim Bayit/2 Chr 32:8, Dibre HaYamim Bayit/2 Chr 2:12; 26:5, Dibre HaYamim ALphæh/I Chr 12:22, SMB/Gen 49:25; MT/Deut 33:26; Ezra 1:4.]

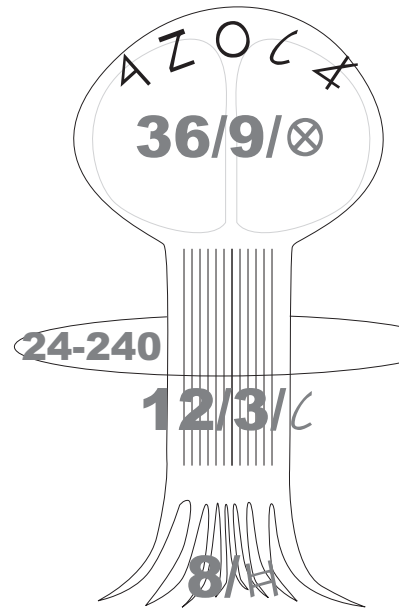

From the Centre of Heart comes the Kephúw ALhhim which branches forth on two sides as a Tree of Lives. The kuwahen/cohen sits at the left hand of AL from which the Priest serves the Bread of the Presence. Coming from the Kings chamber on the right hand, a kuwahen/priest serves on the right side of the King bringing forth teachings of illumination—broken Bread. Positions of serving at the left or right is determined by the transmission of ALphæh gathered and opened between the two sides which are appointments of the Fathers (Menachem/Mrk 10:40).



The reductive value of Melak/king is 9, the basic formulation of the paired letters of the Rock and the value of Knowledge, being the sum of the third row of paired Letters of ALhhim. The reductive value of kuwahen is 3, being the root of the Rock and the value to determine the width and the states of branching the Mind; with an utterance of 2:2 as all priest stand in pairs. Kuwahen, with the value of 30, corresponds to the Lammæd, as the Rod of the Aharúwan is with the priest/serving illuminator.

### 4IOC4—The Tree of Lives

The Tree of ALOZAR is comprised of 8 roots. The 8 roots are comprised of the Zayin (7) and the ALphæh (1). The trunk is the Lammæd/Scepter/12/3 in which are all three houses of Wisdom, Understanding and Knowledge for from the trunk are the roots of Wisdom and the upper branches of Knowledge. The trunk is the central part of the seed from which all things descend and ascend. The upper paired branches of Knowledge are of the Oyin and Rayish, a value of 36/9. The branches of the Oyin and the Rayish are of the same position, that which is in the midst of the sides. As the right side of the Letters is folded upon the left side, or as the right comes to rest beside the left, the Oyin is upon the Rayish and thus provides a circle of light around the head. The Union of the Rayish and the Oyin convey the full consciousness of

Thought. From this configuration comes sayings that ALOZAR is All Knowing, the All OmniPresence.... The strength of a tree is determined by its pairs in the Girdashi State. The mastery/Yevusi State of a Name rises from its strength as all join from the base to the crown.

According to the traits of ALOZAR all Names enter into the Land of the Kenoni unto bringing forth their full branches. Each Name is of TheRock/haTsur, being 8/Æ. Within each Name/Shem are the 12/ℓ houses of YishARAL whereby all traits and levels of Wisdom, Understanding, and Knowledge are known collectively. As the facets of a Name expand, the Collective consciousness that comprises totality/the 36/9/⊕ is entered into which is the OyinZayin dwelling of Light.

**The full stature of the Name** is comprised of the depth, the width/extension, the height, and the breadth. The depth of ALOZAR is the value of 8; the width is 12; the height is 36, and the breadth is 24-240. From the depth of the Rock comes the Fire. The Fire breaks open in the Tsur/Rock. Via the two united flint stones striking upon each other, as their sides are joined, they create a spark. With the Fire, the Fingers of Elohim write the words of the Túwrah. The width is the extension and the means to couple all of Wisdom and Knowledge in Unity, being 12, the width is the rule and governness of Light that extends in all space and dimension. The

The Fire of HaTsur — The 8 = 308 HW, 11 Y

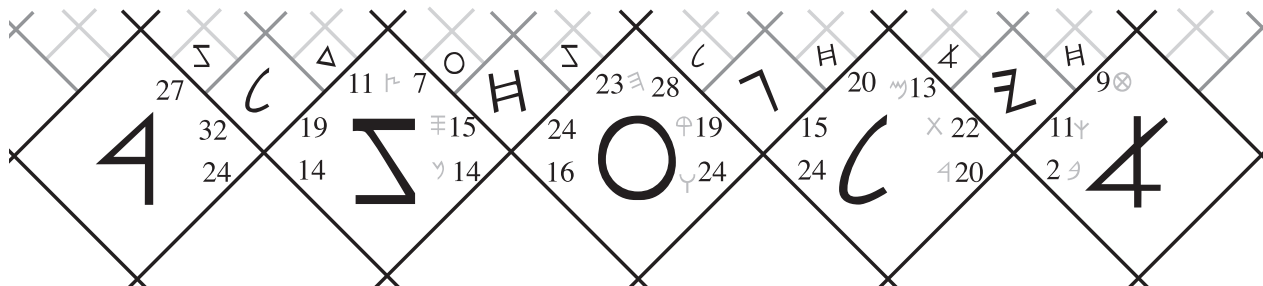

**THE FABRIC OF A NAME: ALOZAR**

Each combination of Letters forms a space in their midst. The spaces formed are bonds amidst the Letters. For example: between the ALphæh and the Lammæd there are 10 spaces; hence, the Letter Yeúwd appears in their midst. The Oyin amidst the Zayin and Chayit is the inner ring of the Oyin conveying the presence of the consciousness of the Ayin, as a zero. Note the patterns of thought within the Name with the ALphæh Yeúwd ALphæh, the Lammæd GammaL Lammæd, the Oyin Chayit Oyin, and the Zayin Lammæd Zayin, displaying the United Order/4ℓ of the Oyin Zayin/OI dwelling. The Letters in the first and third levels and on the two sides are the means to connect the threads. The Letters are Numbers, and the Numbers may be transposed as Letters, whereby one discerns the Presence of 21 Letters/Number combinations within the Unified Names Most Blessed.

height, being 36/9 is the highest number/value which conveys the consciousness of totality of all sides. The breadth, being the expansion of 24 to 240 conveys the Elders within the Name and the means to reach unto the uttermost side parameters of the south. The parameter Letters of ALphæh and Lammæd/13/4 + the Rayish/20 affirm the presence of the 24 Elders at the head and the rear guard of the camps. The 24 are the United House of Names, being the KephúwDalleth/ΔΥ, via which the sides of the Teraysarun of two Names are united unto their complete extension. In the determining the Breadth, we count the parts of each Letter that comprises the width, for both sides of the Letters must be accounted to determine the extent of the

encircling consciousness. According to the Breadth of a Name a “shadow/circle of Light emanation” is cast that affects all that the Name comes into contact. The Breadth of a Name is the sphere that a Name dwells. This sphere is the city and the lands of the Names.

Each Name is a strand of thought that is paired and thereby sent forth two by two according to the association of Thought. The pattern of two by two is evident in all things. **Each Name belongs to one of the four Heads of Understanding according to the timing of their birth.** Though one belongs to Wisdom and or Knowledge, their Name is the fruit of that which is brought forward during the seasons of the year. **The seasons are according to the Heads of Understanding.** From the Heads of Understanding, the Heads of Wisdom come forth, via which the Principle of the Season is sown. Upon the Heads of Understanding, which bears the branches, the fruit of Knowledge forms. Thus, if one is born during the months of Yahúdah, Yishshakkar and or Zebúwlan, their Names are the fruit of the Yeúwd. Those born during the months of RAúwaben, Shamoúnn and or Gad are the fruit of the Oyin. Those born during the months of Aparryim, Manasheh or B’Niyman are the fruit of the Shayin. And the Head of the Neúwn brings forth those born during Dan, Ayshshur, and Nephethi.

The inner nature of the Name is the Kephúw/¥/11 which is the Value of Understanding the Name of ALOZAR/308/56/11. From the inner most value of thought the two sides or parallel universes of Light emanate.

### The Fabric of a Name

According to the strands of Thought of each Name, a Name is woven into the fabric of ALOZAR. The formulations of the Letters and the Numbers, as illustrated in the Name of ALOZAR, contain all Principles—Letters and Numbers of ALhhim. Through the Name of ALOZAR all things are given to the Mind of Understanding—Bayinah to formulate with Wisdom/Chækúwmah the Principles within the Name.

The chart of weaving the treads of a Name, may be used as a guide to detailing the fabric of every Name and word. In the chart are three levels of information, each level being a weaving of thought that is within the fabric. A fabric contains multiple levels of threads, as the layers of material to comprise the Mishkan. Generally, the fabric is comprised of three levels as denoted in the materials that cover the Mishkan. The primary level is composed of the Letters that comprise a Name. In the example provided, the Primary Letters are ALphæh Lammæd Oyin Zayin and Rayish. Within the midst of the Letters are spaces of Understanding. These are the supportive level of Elohim within a Name/Word. In between the primary and secondary level, are a third level of Letters, via which the a Name branches and yields its fruit.

The giving of the ALphæh in the Name of ALOZAR causes expansion of Mind/Rayish. As the ALphæh is given, the Oyin appears. Through the consciousness of the Oyin, the Zayin extends and transmits the ALphæh to the Rayish. The ALphæh is passed from **head to base or base to head**. As the ALphæh is given from head to base or from base to head, a **circle** of Light appears. In this manner, the sun and moon and all orbits of thought are formulated. The head to base position is the means to create movement and expansion.

As the Names are aligned **base to base** in the primary level of the fabric, the corners of the pieces of clothe are joined. The joining of the corners creates the **cube** in which are the three Teraysaruns of Wisdom, Understanding and Knowledge. First the base of the cube is established by the union of the corners of Nephethli-Yahúdah and Gad-Aparryim. Then the upper level of the cube is formed by the union of the corners of Zebúwlan-RAúwaben and B'Niyman-Dan. As Breath fills these two layers, the cube expands into the Oyin consciousness. The base to base position is the mean to transfer Wisdom.

Names are joined **side to side**, whereby the trunk of Understanding is formed, being the cone or the **cylinder** of the Qadam/Origin. Via establishing the trunk, continuous ascension and branching is stimulated from the Centre of Madai and the Union of the sides. The side to side position is the means to transfer Understanding.

Names join **faces to faces**, as in the configuration of the Menurahh. Being faces to faces is the unity of **the branches** which come out of the sides seated upon the base. The fiery bush fills the three Teraysaruns with Light from this orientation of Names. The faces to faces position is the means to transfer Knowledge.

The **Zayin/Tongue** is the means to transmit the ALphæh from left/north to right/south or right to left as the ALphæh passes from right to left or left to right. In order to transmit the ALphæh from east to west, the east gate must be first opened and then the ALphæh can be opened to impart the Light from the east to the west. Once the ALphæh is transmitted from the east to the west, the gates are sealed until the Rock is moved from the mouth of the well by the Illuminated Mind/Priest of Knowledge, depicted by Yaaqov. Until the ALphæh is given from the east to the west, the west does not emit the Light. Upon the east imparting the Light to the west, the west opens and gives forth the illumination received. Upon the west giving of its storehouse, the gates are then sealed whereby there is no robbing of Elohim from the inner treasuries.

Via the positioning of Names, the Letters of each Name, are knitted and woven into the collective fabric of YæHúwaH [Col 2:2, 19]. The tzitzit/fringes on the garments hang from the Letters on four sides via which the Names are woven from the sides or from the base or head.

The **manifestations/faces/Paúwah/𐤒** of Thought do not appear directly within the Name of ALOZAR but proceeds to appear in the collective expressions of all Names coming out of ALOZAR which are the Faces/expressions of YæHúwaH. The faces/Paúwah appear with the Letters GammAL/𐤂 and Yeúwd/𐤅, in conjunction with the giving of the Quphah/𐤑, the state of Enlightenment of the Kohen. The Paúwah/expressions are seen according to the state of the collective mind. To bring forth the expressions of ALOZAR—*to be formless, weightless, and immortal, we align our Breath and Mind in accordance with the Girgashi State*. Within the spaces of ALOZAR (see the chart of the Fabric) the Letters of the GammAL/3 and the Yeúwd/10 are evident. The combined value of these Letters, being 13/𐤌, together with the Dallath/4 culminate in the value of Paúwah/17. Hence, manifestations appear according to the conductive transmissions of thought, affirmed by giving. The giving via a channel of communications—GammAL produces a transmission wave of the Mæyim. The Dallath connection is in

relation to the state of the Teraysarun being projected. According to the frequency and the wave, the level of the expression/Paúwah, in accordance with the level of Yeúwd—giving, arises from the GammAL. As the GammAL is dependent upon the Ha, being a channel for Breath, the Breath empowers the level of expression and thereby the Thought combinations become evident, either in mortality or immortality.

As the root does not flower nor the trunk, the flowers and fruit are in the branches—the Faces of ALOZAR are in the collective Name of YæHúwaH—the Name of the collective branches. For no individual Name portrays their faces apart from the whole/sum, lest they put on the face of shame as in mortality. All Letters/Numbers, *except the Paúwah*, are in the thoughts of ALOZAR. The Faces are not visible nor shall they be within any Name of Light, for no Name of Light belonging to the House of ALOZAR desires to be seen or display the pride of Life, for in so doing one stands out beyond themselves and exist apart from the whole. The Faces of YæHúwaH are the unified expressions that emanate from all Names being United together as they appear on the Shulchan Panayim. For a Name, as ALOZAR, is invisible and seeks not attention apart from the whole. As in ALOZAR, a Name is without form yet is able to undergird all shapes and faces to reveal all inherent Principles of Light.

Lines amidst the Letters in the chart following depict threads which are means to unite and

The Pairs of Letters in ALOZAR and Number/Values that comprise the Name HW / Y

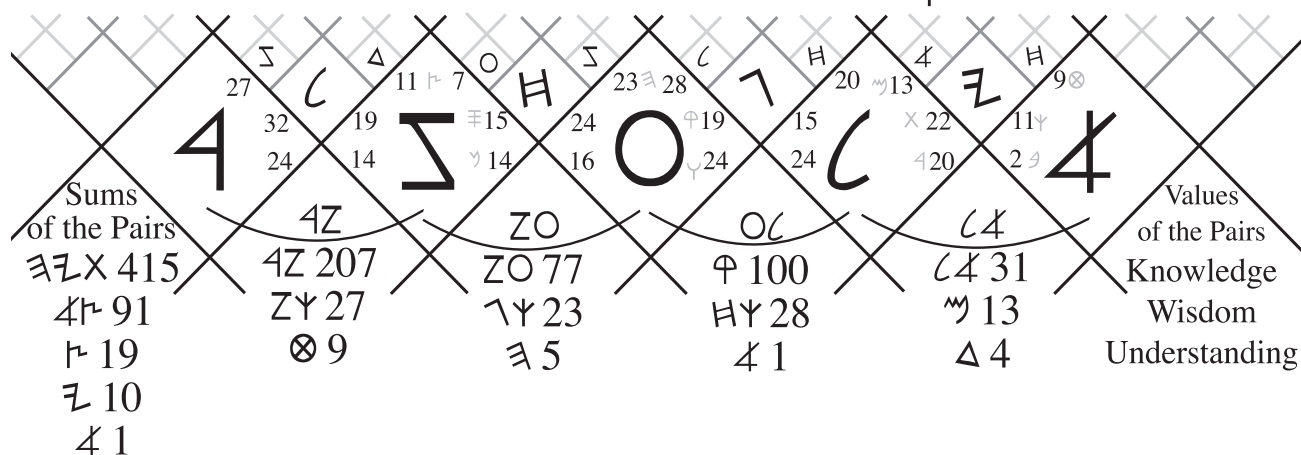

weave all Principles of Light into a fabric of Totality. The extended threads are the tzitzit/tassels via which we unite together Names and words. Each Name is a fabric of thought woven via the Numbers of its Letters and the Numbers within its spaces. Use this pattern to determine the Letters and Numbers within your Name and associated words.

### The Numbers of a Name

Letters that comprise a Name are united whereby they stand together as bonded values one unto another. This bonding of Letters within a Name/Word is the weaving of a Letter with a Letter which reveals the nature of the sword of YæHúwaH. The Letters are welded together by their Fire

Nature as a Sword from the Tongue of the Priest in ALOZAR. The results of this welding generate the values of their Union, and apart from the Union of Letters and Names, the strength is not known to be implemented and therefore spoken. Though one may speak a word, the strength is not spoken until the Letters that comprise a word or Name are welded together as a sword.

Total values of the Name of ALOZAR is 308/אָW, which reduces to 11/י. Both of these values denote the Fire of the Rock and the United Branches or Pairs of Thought from which come the Union of the King-Priest. Hence, all that are of this most blessed Union are called to be kings/masters and priests/enlightened servants of the United ALhhim and Principal ALOZAR [Chazon/Rev 1:6; ALphæh Kayphah/I Pet 2:5]. Note the values within the pairs of Letters in all dimensions of thought within the Name of ALOZAR—in the realms of Knowledge, Wisdom, and Understanding. The summation values of the pairs reveal the inner strength of the United Letters and their activity of composing and extending Light: 415/אָלX; the ability to transform a state via the exchange of ALphæh/Concept from AL/לך to AR/ך: 91/ך, and the transformation process: 19/ך that leads to full extension: 10/ך and oneness: 1/ך. Each of the sum values: 415, 91, 19 and 10 each reduce to the Number of being ONE/United Pairs of HaWahHa. Use the following chart to determine the welded Letters within your Name and the words that pertain to your Name of Fire that are formed by the Letters and Numbers being woven and welded together.

ALphæh Seed Principle is extended by the Yeúwd/giving amidst spaces between the ALphæh and the Lammæd. The presence of Yeúwd signifies the Nature of AL to give all. As a result of giving, 10 lands appear from the midst the ALphæh Lammæd to form the OyinZayin body. Through consciousness of Paired Names, ALphæh with AL/לך is passed to the Rayish/ך, which is the foundation of the word, Light/ךך. Thus, from the Nature of AL/לך the Light is given to the Mind of the King whereby the Earth and all that is within it is formulated according to the Oyin/16/ו — Zayin/7/י Body of Light/23/5/א. As the King/Rayish receives the Priest/ALphæh Lammæd, the Kingdom of Light is established for all centres of the inhabitants thereof.

Giving of the ALphæh occurs as the first oylah offering of the Lamb is made, via which there is Light. **The offering is made by AL, being the Priest of ALOZAR.** The results of the offering—the giving of ALphæh, is a body, referred to in the Túwrah as Aretz/Earth/ךך. The earth is formed by the Rayish as it is given from the Hand of AL. In accordance with AL being the Kohen, the rod is within the hand of Aharúwan. According to the inner workings of the Yeúwd—the Hand of AL, the Lights are given and positioned within the OyinZayin Body. This body of Light is also designated to be the Lamp/5/א of the Temple—the Shayh/Lamb—that illuminates the dwelling of the Assembled Tribes/Branches of the Mind of ALOZAR [Chazon/Rev 21:22-23] whereby the inward has no need of exterior or reflective illumination. The inward state becomes fully whitened whereby it operates by the Light and needs no exterior illumination to proceed, for the inner eyes have been opened. The blind, that follows after forms, has been healed. When the inner eyes are opened and they behold the Principles of ALphæh within the Hand of the Priest, the blind are healed. Therefore one proceeds in LIGHT as an immortal and no longer walks according to the body of flesh.

The Derek/Path to ALOZAR  
There is a path into the midst of the Fire

where the Single Voice is heard,  
 a Voice familiar to us as our Breath,  
 to whom we have always belonged—  
 AL-OZ-AR.

Into the centre of United Names  
 a Way opens  
 within the United Circles of Light.  
 Proceeding through the open portals on four sides;  
 the parameters of the squares are known.  
 With Understanding we pass through  
 the secret chambers of the Queens,  
 through the Gate of the Neúwn.  
 Before us is the screen of the golden sheath.  
 The Path of The Holy One is known through giving all  
 and abiding within the Assembly of United Names.

The Fire of Breath  
 comes out of the innermost room of the heart,  
 fills the curtains of the lungs,  
 and smokes out of the nostrils.  
 The Breath carries the words arising from the heart  
 and places them upon the tongue.  
 As the words are given, they fall unto the loins  
 and rise to fill the mind and all of the houses of Mind.

The Breaths entering into the path intertwine and make a dwelling  
 In the GirGashi state of pairs.  
 Via their Union they fill the house with the abundance of the Fire  
 of AL-OZ-AR.

*The path through the Mishkan/Tabernacle leads us to the veil of ALOZAR. The path/derek is a route, as example, the blood is a path unto consciousness with the Breath. The flow of blood is opened during each oylah offering/sacrifice. Follow the route of the blood to the heart. In the channels of Breath, we behold how an idea is carried through all of the members.*

The study of AL-OZ-AR and the corresponding pairs of Names belonging to ALOZAR is being into the Midst of the FIRE. The Fire of ALOZAR never goes out. The Fire is an nervous impulse. Like an ignitor, the Fire is the impulse of the MIND that continues to flicker and ignite all that it comes in contact with. This is the consuming Fire of the NAME, being ALOZAR, of YæHúwaH. In the state of the oylah offering nothing remains as it is because it is in contact with the Fire. This is the meaning of the perpetual on-going oylah—the complete giving of LIFE. **As we make the oylah each day, we are in sync with the Fire in the midst of the Lights.** The Fire determines what is happening at all times and what is undergirding to achieve the next move; however, *if our minds are not in tune with the Fire, we do not comprehend what is going on.* The more we are in tune with the Fire, the more we know and proceed in the Light.

Yet if our members, within our tabernacle, are operating by a strange fire, then we are estranged from the Fire of the altar.

“Strange fire” is detected at the Mizbaach/Altar of Incense where Nadav and Aviyahua/Avihu, being the first of the enlightenment, rise from North into East as one emerges from Metsryim. As Mind commences to discern the presence of their Light, elements of carnality cause the Fire to burn with foreign elements. Nadav is positioned within the Mishkan on the North side, and Aviyahua is positioned at the East side. Together they proceed unto the East, unto the Mizbaach haQetotet/The Altar of Spices/Incense via emerging consciousness of ALOZAR. Being of the initial enlightenment of Aharuwan in your Name, they proceed to enter the Light to approach the fiery blaze in the East that carries the Origins of the oylah in the North [TeúwratHhaKuwahnim/Lev 9:24-10:2]. As you ascend with Enlightenment of Dan, emitting from the North, you come into the East flowing Nadav and Aviyahua who open these portals. When one rises in the East their faces are toward the South—the full illumination. In South they encounter the Faces of ALOZAR which blazes to illuminate Mind and Names unto their ascending target. ALOZAR consumes strangeness from seekers who desire to go beyond the veil. In that their hearts are for YæHúwaH, the Fire consumes the strangeness as the Rod of Aharúwan consumes serpents/strange tongues of Pharaoh. In so doing, Names of Nadav and Aviyahua extend from your Seed into the southern Faces of the Light. They are transformed from one state unto another. This is the meaning that *they died as a self-sacrifice to the Faces of YæHúwaH* whereby they serve HhaOuwim/𐤎𐤐/the People of YishARAL with purity and full revelation. In that the oylah of the House of Aharúwan and the offerings made on behalf of the people are acceptable by the Fire of YæHúwaH, so are the Names that make the oylah [TeúwratHhaKuwahnim/Lev 9:1-24]. What is strange in your midst becomes consumed. Your transformations are according to your giving and walking unto the South which brings you unto a whitened State. Remember, the Túwrah is the path of Lives, and what comes out of death is the full extension and revelation of the unity present within.

𐤀𐤋𐤐𐤐/ALozAR is our OZAR/HELP of the United Rock which composes Light and the states of becoming [MT/Deut 33:7]. There is none like the EL of Yeshurun: 𐤀𐤋𐤐𐤐/ALozAR is a chariot of Names in which is the OZAR/Help unto all productivity. [MT/Deut 33:26]. 𐤀𐤋𐤐𐤐/ALozAR is the Shield of the OZAR unto all of our branches on the Tree of Lives [MT/Deut 33:29].

𐤀𐤋𐤐𐤐/ALozAR is the OZAR/Help of the unified Neúwns within the NAME of YæHúwaH. ALOZAR is the One of the Collective YæHúwaH, the maker/fulfillment/doer of the Names and the earth [Tehillah/Ps 124:8]. In 𐤀𐤋𐤐𐤐/ALozAR are the ALhchim which are to us a refuge and strength, a Help in difficult straits/narrow confines [Tehillah/Ps 46:1-2].

Eight Letters of HaTsur/the Rock are in ALOZAR from which come the Heads of Wisdom and

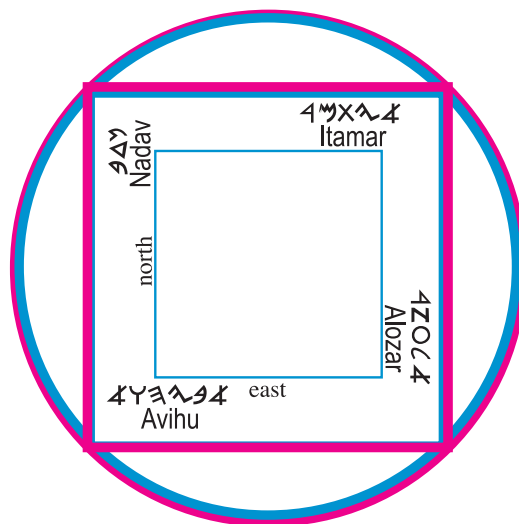

The chambers of Kuwhænim/servant priests are in the midst of the United Circles from which they serve the Four Faces and regulate four gates/mouths. The four offspring of Aharúwan are the base of enlightenment.



Understanding. Within the Name of ALOZAR are the Names of Aharúwan, maShayh, the Shayh, ShmuAL, and others. Three levels of the Name of ALOZAR contain twenty-one Letters. The Letters and the Numbers are within the construct of the Letters and Spaces of the Name 4TIOŁ4/ALOZAR.

Four heads of UNDERSTANDING and WISDOM are in the Name of ALOZAR. Out of ALOZAR comes Bayinah, the Queen of Understanding; out of Bayinah comes Chækúwmah, the Queen of Wisdom. As the two sides of united Names branch, they comprise the united Faces of YæHúwaH and become twelve sided, a union of two squares/cubes. 4TIOŁ4/ALOZAR is the Rock of the two united squares upon which the House of YæHúwaH is built. ALOZAR speaks through the Name of YæHúwaH as one speaks through their collective Faces. In many cases, where the text reads, The Name of YæHúwaH, the Name referred to is ALOZAR from which YæHúwaH is derived. The collective Name of YæHúwaH depicts the Name of Knowledge encompassing all faces/expressions of Light.

All of the instructions that we have received prior in the House of Dan, in knowing how to read words and the spaces in the words has prepared us to receive the Unified Names—those Most Blessed Names of AR-AL. ALOZAR is the Fire-Writer of the Túwrahh whereby the thoughts of ALhhim (The United Principles) are composed. Most scholars attribute the authorship of the Túwrahh of ink to be OZRA/Ezra, a Name corresponding to ALOZAR, as the one who receives of the Mind of ALOZAR. Ozra authors the Rayish Scroll, known as Ezra, which depicts the Head receiving the ALphæh of AL.

Within the House of YæHúwaH is the chamber of the Kuwhænim/servant priests, being a square in the inner most part of the Haikal/Temple. The House of YæHúwaH is founded upon the united squares of Bayinah and Chækúwmah, Bayinah is directly upon the square of Chækúwmah. Within the chambers of the Union of Lights is the United Name of the Enlightened Mind—the inner most square of The King-Priest of ALOZAR. The structure of these squares are referred to as courts of the Haikal/Temple of Names. The gates into these courts is through the twelve tribes/camps, which are known as the Branches of a Name. The way into the Centre is via the branches, and every branch has its course way unto the MIND. This structure of the Lights is within every pair of Names, whereby the Names know intuitively to verify the Source—ALOZAR, within Bayinah—the surrounding spirals of consciousness in which they move and have being.

The evident pairs of circles within the head and in the body number 14 pairs. The 8 circles in the head are united as Names are joined to comprise the 16—the Oyin thought consciousness whereby what is seen, heard, spoken and discerned in the portals of the nose to the lungs is within the Mind of the Oyin. In becoming united, joined Names do not see, hear, speak, or discern apart from the Oyin/O.

**Evident pairs of circles** in the lower region of the body are those of the kidneys, the testes, and the corona. These six pairs are of Wisdom, residing in the King's Garden of Aparryim and Yahúdah (Ephraim and Judah), which form the base for the Heads to be crowned. In the Union of Names these pairs are 12 attesting to the means of expanding/blessing the Name of Alozar.

Together, the pairs in the head and the pairs in the trunk are 14. This number is according to the Neúwn that encircles us each night and day with a weaving of Light whereby the circles are formed. Through joining the corners of Gad and Aparryim, the Oyin Body is united from the base to the crown, and one speaks according to blessings/expansions of the Seed arising in the King's Garden. In the midst of Gad and Aparryim is the House of Laúwi, which are the joiners of the tribes into the House of YahuWah. Unifying the Names, Gad and Aparryim, at the corners brings forth the Stone of the Temple that is laid within the foundation to the crown. The Stone rises from the base and provides the adornment at the top of the Teraysarun. The united sides under one head is a declaration that the full measurement of the joined Names have been achieved. The Stone is within the Dallath of the Foundation of the Teraysarun and arises to the Head with shouts of grace/favor [ZecharYah 4:7], for it is through sequential and multiple bursts of grace that the Stone rises and comes to abide upon the dwelling of the United Names. The bringing forth of the crowning stone is what all Names seek to complete.

The Names of the 70 are a formulation of parts/halves, being 140 which is the full extension of the Neúwn/14, or the Neúwn to the tenth/extended power. Within the 70 Names are the pairs of thoughts that comprise each side to be a Head, Body and River of Life.

Abiding in the East there are 7 offspring of Yahúdah, 4 of Yishshakkar and 3 of Zebúwlan. According to the Cardinal Numbers, there are 14 parts in 7, thereby being 14/7 parts of Yahúdah, the 8/4 parts of Yishshakkar, and the 6/3 parts of the three extensions of Zebúwlan. As we read the side of the East/7ΔΦ, the cardinal numbers form the word, 7Δ7, meaning to be guided or led according to the Qadam/origin from which comes The House of Núwach/47 United/7.

Within the South there are 8 offspring of RAúwaben, 5 of Shamoúnn and 7 of Gad. According to the Cardinal Numbers, there are 16 parts in 8, thereby being 16/8 parts of RAúwaben, the 10/2 parts of Shamoúnn revealing the HaWahHhúwa Principle in the midst, and the 14/7 parts of the seven extensions of Gad whereby one speaks according to the Neúwn/perfection. As we read the side of the South, they form the word, 770, Oyin, The House of the Eye.

Within the western side, there are 4 offspring of Aparryim, 14 of Maneshayh and 7 of B'NiymaN. According to the Cardinal Numbers, there are 8 pairs in 4, thereby being 8/4 pairs of Aparryim, the 28/4 pairs of Maneshayh, and the 14/7 parts of the 7 extensions of B'NiymaN. As we read the Numbers (8/4, 28/4, and 14/7) within the Letters on the side of the West/77, these values comprise the word, 744, meaning the Principal of grace, favor and the means to beautify. Concerning the House of Yúwsphah (Joseph) on the west side, it is a side of grace and favor [Sepher Maoshah Bereshith 39:4]. The primary form word, 744, is altered to be the word, 774, as the ALphæh, being the base of the Yeúwd, becomes fully extended whereby the Yeúwd appears in its place: 774, meaning the full measures of grace and to vitalize. According to this grace, all truth and Principles come forth and establish the perfect thoughts unto one's full measurement [Yahuchanan/Jn 1:16-17].

Within North there are 1 offspring of Dan, 6 of Ayshshur and 4 of Nephethi. According to the Cardinal Numbers, there are 2 pairs in 1, thereby being 2/9 parts in Dan, the 12/6 parts of 6 pairs in Ayshshur, and the 8/4 parts of the 4 quadrants of Nephethi. As we read the side of the North/977, they form the word, 89, meaning to flicker as the light of the fire flickers in wind.

The 70 United in pairs:

the 7 of Yahúdah with the 4 of Aparryim = 11/7  
*the means of branching the complete values with blessings;*

the 4 of Yishshakkar with the 14 of Manasheh = 18/4  
*the means of transformation in all levels through assignments/deeds;*

the 3 of Zebúwan with the 7 of B’Niyman = 10/3  
*the means of extending the lands through productivity;*

the 8 of RAúwaben with the 1 of Dan = 9/8  
*the means of consciousness with totality through perceptive judgments;*

the 5 of Shamoúnn with the 6 of Ayshshur = 11/5  
*the means of branching through comprehending and affirming the sides;*

and the 7 of Gad with the 4 of Nephethi = 11/7  
*the means of branching through words and meditation.*

Paired Names comes from the side of Yaaqov, that being the side of Knowledge, which brings forth the height of the Tree of Lives via the united/6 branches/7/11 to yield 66. The 6+6 are the inner and outer walls of the cube; the circle around the cube is the 70. With the extension of Yúwspah comes the 70/Oyin: comprised of the 33/6 of Leah, 16/7 or Zilpah, 14/5 or Rachel, and 7 of Bilhah. The sisters: Leah/6 and Rachel/5 convey Wisdom/Leah and Understanding/Rachel—the

Gad, the tongue of the serpent that connects the Ayin Body, the Zayin to the Ayin, as one circle of light, the Upper Passage of Ephrayim

The 14 circles of thought are the paired expansions of Yapheth, each being derived from the 7 primary openings



The 14 Pairs of The Nun / 7 Extended



The 8 circles in One circle

The compound circles of the ears are composed of three gates on each side of the body

The 6 circles in One Body

branching of 11/Υ. The maids of Zilpah/7 and Bilhah/7 together bring forth 14/5. The reductive values of 11 + 5 together confirm the thought of the 16/Oyin, via which all branches of mind are brought forward. Through Yúwsphah the Mind is drawn out to behold the Circle/Consciousness of Light which is the breadth of our dwellings. The lands of YishARAL are Circles; the centre of each circle is the city; the outer circle is the field. From the egg to the zygote to the head to the

## The Bridges of Paired Thoughts

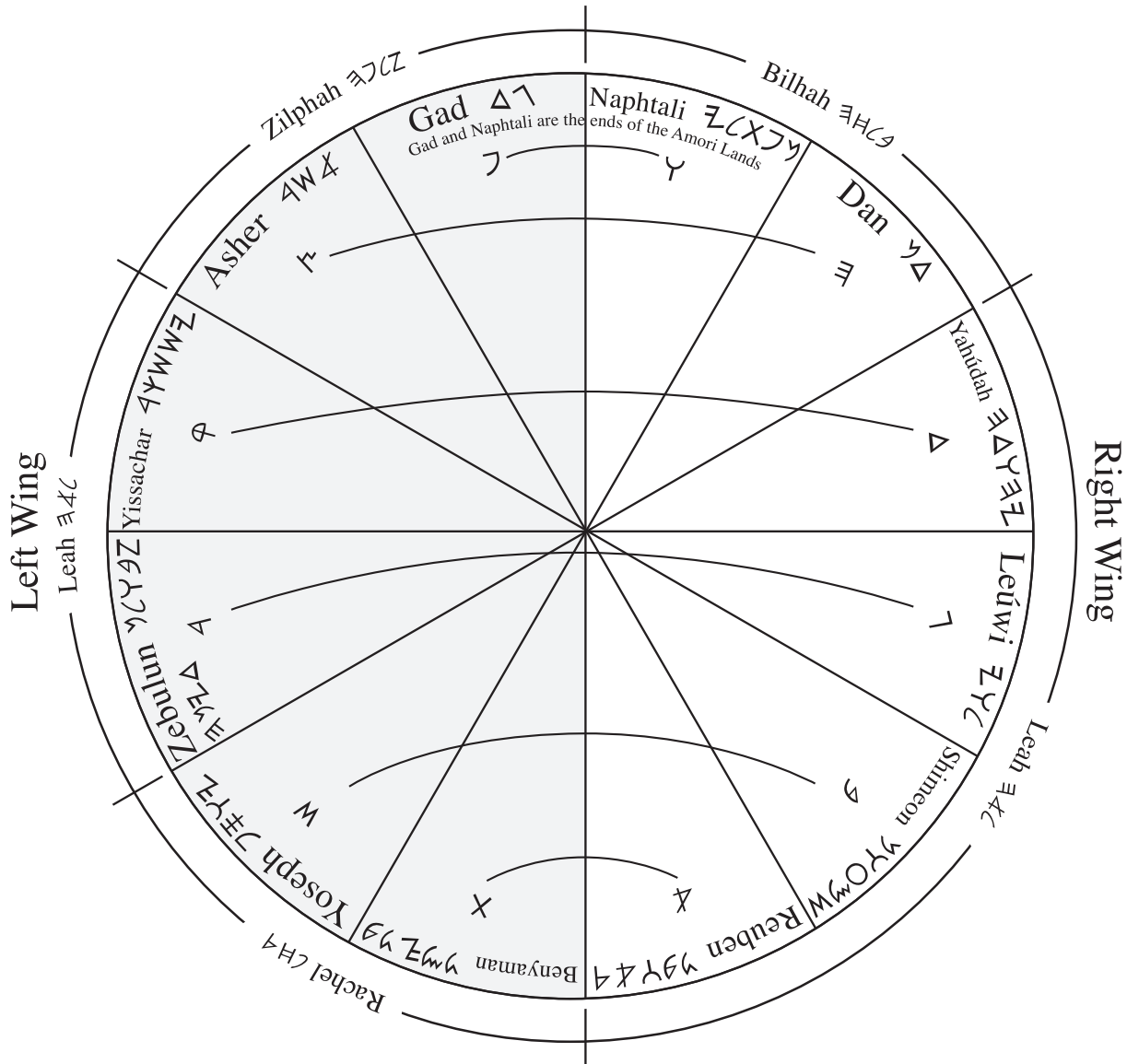

The six pairs of Thought that cause motion of the whirlwinds whereby one flies/moves/makes progressions.

X4, W9, 47, 94, 13, 77

Each pair is a value of 23 / 17 via which the camps/Tribes move and have their Being of Light/11.

corona; the collective family of the tribes make their progression. The entrance of the ZayinRoot into the OyinHead is the base of the union of the ZayinOyin that makes the circles of lives.

Your camps move according to a pairing of thoughts. Once a seed/concept is accepted at the Southern Gate of RAúwaben, the movement of the Principle flourishes. The stories in the Túwrah convey movement and progression via the union of the tribes. Shamoúnn, when bound to Yúwsphah, is the impetus for the entire family to bring forth B'NiymaN into Metsryim/definition. The Union of Laúwi and Zebúwlan leads to the movement and occupation of the Lands of the Oyin, for until the parts of the lands are joined, progression is halted. Yahúdah and Yishshakkar cause values to be implemented into labor, whereby a project gets moving and accomplished, for until we know the value of a work, we do not put our hand unto it. The union of Dan and Ayshshur carry forth judgments, and via affirmations we proceed unto our next level of residence. Gad and Nephethi enable us to proceed into all states of the wilderness/Word formulations. Every word comes from one of the four centres of the heart and is spoken via the mouths of the four heads of Understanding. Via speaking the messages of the heart, the formulates the direction and states unto its encampments. Thus the children of YishARAL journey unto the states of their habitations. These journeys are achieved by the coordination of thoughts whereby the wings of the Names receive the nervous impulse to take flight.

In the chart of the Bridges of Paired thoughts, Dinah appears as Dan breaks through into the eastern flow of Zebúwlan. The birthing of Dinah amongst the tribes brings for the days of the judges into the lands and the triumph unto the Yevusi state.

The Land of the Girgashi is comprised a pair of Names. Both the Name, *Gir/4^*, and the *Gash/W^*, commence with the letter *GammAL/^*, denoting this state is via united communications/^ with Priest/Mind of Knowledge/4 and communication/^ with the King of Wisdom/W. The perspective of a person seeking Knowledge/4^ affirms the Wisdom/W^ of the collective residence with overtones of humility. [See the Túwrah Dictionary notes under *ger* and Hagar. Refer to the alphabet charts under GammAL, Rayish, and Shayin.]

The Girgashi corresponds to the fourth finger of the left hand and is paired in association with right hand fourth position meaning to verify, to confirm according to the ascent. The phrase of being B'Churab (in Horeb) is fulfilled in the Land of the Girgashi [Sepher Yetsiat Metsryim/Ex 3:1]. ***The path leading from mortality flows from the illumination of associations.*** The Girgashi state is an adornment of the elevation of the Kenoni, due to humility, whereby the favor of the ascension falls upon the head of the Girgashi.

## *The Land of the Yevusi Thought Level*

10. The **Yevusi/יְבֻסִי/Jebusite/State of Oyin/left little finger**; the state of mastering all things via the expansion of Principles within and intertwining of Names; the unveiling of all Heads via the seven circumcisions whereby the Principles are revealed in Light.

The Yevusi is the tenth position or the full extension of the Lands within the Eye of Avrehhem. The land is associated with the little/fifth finger on the left hand, which corresponds to the little finger on the right hand in abilities to govern. The Yevusi is the active state of putting underfoot our enemies. In the Yevusi, there are no obstructions to your progress or fulfillment, for all has been arranged and ordered according to the Master Name of ALOZAR.

The Yevusi State encompasses the threshing floor where the grain is trampled for its full extraction. The threshing floor is within the city of Jerusalem, belonging to the Yevusi. Those in the Yevusi land are of the family of B'Niyman [Yahushúo/Joshua 24:18]. The Yevusi meditate and continue to extract and process the everlasting fruit of B'Niyman which renews and expands the States of Consciousness, shaping and filling the worlds to come, those emerging from the United States of YishARAL. The Yevusi refer to the throne, from whence one governs the States of their kingdom, and hence, the Yevusi is the centre in which we come to the throne of ALOZAR. The Yevusi State is bringing the ALphæh to the RayishOyin Head within the Name of ALOZAR; it is the King receiving and implementing all Principles of the Priest. In this Union, the Order of Melchizedek is founded.

The Full Circle of Names unto being Kings and Priests  
to the Unified Order of ALhhim and ALOZAR

The circle of Lives and the consciousness of the Court of Names come forth of ALOZAR. In the midst of ALOZAR/4IOŁ4 comes forth Bayinah, the Oyin Queen of the North. From the Queen of the North comes Chækúwmah, the Queen of the South. From the Union of Bayinah/O and Chækúwmah comes forth the Union of YæHúwaH/אָפּאָפּ, being a Union of the Lights—the HhúwaÚWahHhúwa/אָפּאָ which are within the Hand of the Yeúwd/פּ via which the Lights of the day and night rule. In the Name of YæHúwaH the Names of Wisdom and Knowledge are birthed of Chækúwmah and Bayinah with their *hand maidens* which are *extensions of the hand/Yeúwd*. The hand maidens correspond to the fingers of the Yeúwd Head which bring forth the Principle Seeds/ALphæhim for each 12 paired thoughts within ALOZAR. The indication of twelve paired thoughts are displayed in the two primary Letters of ALOZAR, those being of the ALphæh/4 and the Lammæd/Ł, which interpreted means the Seed of 12.

Bayinah appears as the ALphæh is passed from AL/Ł4 to AR/44 which expands the mind and therefore brings forth the Oyin/O consciousness. Whenever a seed is passed, the Oyin increases. An ALphæh is transferred by the Zayin/tongue/penis which is the base of the Oyin that ever surrounds the Rayish. When a Principle forms and fills the Oyin, it then enters into the Rayish/Mind, for the Oyin is the Sheath—the whitened encircling garment of the Mind, being born of the Rayish, the Oyin drapes itself upon the Rayish, as the Letters of the right side come to rest upon the left side. The seed can be passed also from the Rayish through the Zayin and Oyin to the Lammæd whereby that which is in the Rayish is affirmed by the Priest within AL/Ł4. As the Seed/4 is given freely it establishes a foundation/Ł of the crowning Rayish/King. In the passing of the Seed, the Oyin Queen appears in the process of giving. The Oyin is the Queen of the North—Bayinah. In that Bayinah is of ALQZAR, the Queen gives all things likewise. The giving of Bayinah brings forth Chækúwmah which appears amidst the Letters of the Oyin to the Rayish. In that Chækúwmah is of Bayinah, the Queen of the South is a giver of all

things also. Together through their givings, the mind branches into twelve pairs, which is unto the sceptre/ℓ in the hands/ℓ.

### The Scepter/Rod/Lammæd in the Hands of maShayh and Aharúwan

What is in your hand [Sepher Yetsiat Metsryim/Ex 4:2]? The fingers bear testimony of the twelve or the Scepter/Lammæd within the Yeúwd/10/Hand. The four fingers of the hand each are comprised of three rings that compose each finger. These four fingers are extensions of thought that comprise the four sides of the Mishkan. The fingers on the right hand comprise the walls of the east and south; the fingers on the left hand comprise the walls of the west and north. As no Name stands without its association, likewise the fingers are joined unto each other to comprise the Scepter/Lammæd. Thus within the 10/Yeúwd are the 12.

***“And YæHúwaH says unto the extended collective:  
What is this within your branched hand?  
The one/unified says, A STAFF.”***

The consciousness of the Lammæd being is the hand can only be stated by one unified. Otherwise, they see no staff in their hand for they see not the ALphæh Principle extended into the Yeúwd that forms the staff of the ALphæh to the Yeúwd. Seeing the staff/Lammæd in the Hand affirms that one is approaching the Yevusi State in which all four Heads of Understanding are unveiled. The Lammæd/staff in the Hand leads unto the Yevusi state whereby what is of the opposition, the oppression, the disease, the mortal, and the captors are overthrown. With the staff/Lammæd, being the 12, maShayh and Aharúwan prevail over all of the waters and the lands of Metsryim. With the staff, the serpents of Pharaoh are swallowed up. With the Rod, Aharúwan leads the collective branches of Mind out of Metsryim unto the full exploration of Mind unto the Lands of the 10. What is extended, being the 12, is led unto that which is within, being the 10/1.

Within the midst of the Name AL is the Hand. As one counts the spaces amidst the ALphæh/ℓ to the Lammæd/ℓ the Yeúwd/ℓ appears: ℓ ℓ ℓ ℓ ℓ ℓ ℓ ℓ ℓ ℓ ℓ ℓ. There are 10 spaces between the Letters of ALphæh and Lammæd: AL/ℓℓ. The ten spaces and the two Letters comprise the 12. The Rod, or the 12 is in the hands. The ALphæh is the base of the Rod/Lammæd whereby “the staff of life,” being bread, is formulated. The ALphæh Seed generates the staff of the living, and coming out of the ALphæh are all expressions and animations of life. What is in the midst of the ALphæh Lammæd, being the Yeúwd, possesses that which is to the right and left—the ALphæh and the Lammæd, even as the one occupying a space controls the space. The one living within a house is the landowner of the property. Hence, via the YEÚWD, and that which is within the hand, one comes to liberate oneself and possess the Lands of their Names.

The Rod within the Hand is comprised of two bases: the Foundation of the ALphæh and the Foundation of the Lammæd. Thus the rod in the hand are unified light rods, being comprised of two bases with two heads. The bases are the ALphæh and the Lammæd and the heads are the Yeúwd and the Shayin. According to the Union of these two bodies, the United Serpent is formed, for each serpent is of two sides or the joining of two sticks/rods into one. The side of

one rod is light, as the belly of the serpent, being the south, and the side of one rod is dark, as the back of the serpent, being the north. As these serpents intertwine, they comprise one serpent with four faces. These two rods joined contain all Letters of ALhhim from the ALphæh to the Shayin. Each serpent is a joining of two heads, one at each end of the united staff. The appearance of the four faces appear devour, through the opening of four mouths, the mortal nature. By the united Yeúwd-Shayin Head, all that projects itself into the Faces of ALhhim is swallowed up/consumed as by the fiery breath of the dragon serpent. According to the rising of the heads in the pairs, the Serpent of maShayh and Aharúwan, devours the serpents/spermatozoa (that which causes mortality) of Metsryim.

The Staff of the Serpent is with the Laúwim/Levites as the Laúwim are birthed in the Name of AL/ℓℓ and dwell in the midst of AL/ℓℓ. Thus the Laúwim are the arm of salvation of ALOZAR. The Name of Laúwi is comprised of three Letters, ℓΥℓ, Yeúwd/10/1 + ÚWah/6 + Lammæd/12/3 = 28/10/1. The Laúwim are begotten within the Midst of AL and positioned in the midst of the Mishkan from where they serve in the amidst all peoples. To the Laúwim are given the Staff to lead all nations to become priests and kings that they be One in the Name of ALOZAR from which all things have come. By their very value/Number and Ordering of Mind, being 28/1, the Laúwim are the priests and the servants of all Names. The heart of the Laúwi loves the House of YishARAL and all nations, and thereby serve by their love for the House of YæHúwaH. The heart of the Laúwim are as the heart of a father who loves those born within their household, and whereby every mind loves all of its members, being the offspring of its mind, that is within and that which comprises their dwellings.

### The Mastery of the Heads

There are four heads of Understanding that are undergirded by four heads of Wisdom. There are two heads of Understanding per side of each rod, thus two heads of the North and two heads of the South. The heads of the North are the Neúwn and the Shayin; the heads of the south are the Yeúwd and the Oyin. The two rods are joined as one whereby the Head of the King-Priest arises from within the fields of humanity. The arising of the Heads within all Names is the emergence of the Head of Mashiyach. The rising of the Heads of Understanding upon the stalks of humanity is the realization that the fields are whitened unto harvest; for the heads, rising upon the inhabitants of the lands, are those which have become illuminated, that is, whitened, and ready for harvesting into the Land of the Yevusi.

The two united heads of the YEÚWD-SHAYIN are the parameters of the four Heads of Understanding. Within the Heads of the YEÚWD-SHAYIN are the Heads of the NEUWN and OYIN. The rising of the heads within the United Names leads to mastery over all nations/processes of thought and over all forms/lands/dwelling states.

The first head that emerges is **the Head of the Oyin**, for this is the initial and supreme awakening of the Mind whereby the the eyes are opened fully as the Eyes of Understanding. Once the eyes are opened, they will not be closed again nor be deceived by the lust of the world, nor will they seek the pride/flesh of life to exalt themselves above another whereby they



accept with pride the robes of flesh and become subject to the carnality of the Pharaoh that does not know Yúwsphah. For whenever the mind operates without knowledge of the base, they are a mind that is as Pharaoh that does not know the Origin of their House in Aparryim. The base of the Head of the Oyin is the Zayin, being the Head of Wisdom located in Aparryim. The Head of the Oyin brings forth the full consciousness of Light. Thus as the Breadth of a Name, the Oyin expands or contracts to always surround the Rayish Mind of Knowledge, whereby it produces a seed coat or what is known as the Oyin Sheath around the Names that are joined as One. From the awakening of the Oyin, the symbol of the halo and other rings around the head have appeared in art. The Oyin Head is the Mind that uses the tongue/penis, according to the base of the Zayin, unto full consciousness. One enters into Unions and one speaks unto ever supplying the Mind of Light with the Powers of Regeneration. Every word spoken is the means to enlighten and expand a concept. *Thus as the Oyin Head emerges from within the branches of the tribes, the eyes are healed.* The one healed begins to see all humanity as trees, that is, as an assembly of unified thoughts that are branching. No one is seen any longer as objects of flesh nor limited to any form/gender or residence in mortality. Via the Oyin, the Principles of Light are assembled within, being passed from one end unto another, as the Zayin comes to reside beside the one of the AR which has received the ALphæh emitted from AL. There is no use of the tongue/penis to abuse nor to harm another, but rather every word that is spoken, and the concepts that are brought forth, are for blessing and expanding the consciousness of all that is within. As a result of the mastery of the tongue/penis, the Principle of the ALphæh is released unto forming another Head of Understanding—the Yeúwd.

The next head to appear is **the Head of the Yeúwd** in the East, which is the Head of Yishshakkar amongst the tribes. This is the Head in the East that belongs to the Kingdom of the South, and thus operates within the dominion of the lights of Chækúwmah. The base of the body of Yishshakkar is the ALphæh, being the Head of Wisdom that is located in RAúwaben. When the Head of the Yeúwd arises, the Mind operates according to the HhúwaÚWahHhúwa Principles of the ALphæh. There is no separation of Mind in the Yeúwd and no actions are performed in servitude to the flesh, for the ALphæh Power has arisen into the arm from the opening of the eyes in RAúwaben. RAúwaben sees clearly, by Dan, and the judgment/discernment of the Light is passed unto the Hand. As the Head of the Yeúwd functions, one holds in their hand the scepter. The hand that was once withered is healed. For until one's deeds are of Principles, they are blind to what they are doing, and the hand withers with the atrophy/degeneration of tissue due to their lack of Understanding what is in the hands and what the hands are to accomplish as the extensions of Mind. When the Head of the Yeúwd arises, one devotes their works unto the Principles of their Names that are united in the Name of ALOZAR/4IOÇ4.

Following the brilliance of the southern heads, those in the North, that have been from the beginning commence to appear amongst the stalks of the tribal branching. For what is beneath comes to rise upon the shoulders of that which is established by Wisdom. In the west, and thereby belonging to the Queen of Bayinah, there rises **the Head of the Shayin**, and at its base or foundation is the feet—the Lammæd. One comes to the Shayin Head of Understanding as they exercise the hands to perform the commandments. For until one performs they are unable to proceed in the realms of Light. Thus blessed are they that do the commandments for they

shall have the right to the Tree of Lives. The Shayin Head operates with the tribe of Maneshayh that is able to consume and therefore transform any state or Name from one state unto another. Out of Maneshayh comes the flame and the oil to lite the menorahh that blazes unto the Head. This Power of Transformation belongs to those who are progressing in the paths of the Lammæd. The one who brings forth the Shayin uses the feet to guide them in all the paths of Light. Their feet will not walk in darkness or lead their members astray after false idols of illusion. The emergence of the Head of the Shayin is the healing of the lame that are yet lying among the pools/states of reflection, waiting for someone with the extended Yeúwd to come into their presence. When one has the YEÚWD, they can say to the lame, “Take up your bed and walk.” Silver and gold we do not have of this world, but in the Name of Yahushúo, the Branch, arise and walk! The Power of Transformation uses the scepter in the hands to rule all things of the night, that of forms, via Understanding the Instruction upon the lips of the priest. And from the flickering of the crown with the Fire that one walks in, comes forth the Head of the Neúwn.

The fourth head is the Source of Understanding, and from its side in the North all proceeds unto the four quarters of the Earth. The fourth head, being **the Head of the Neúwn**, takes its seat in Ayshshur but extends with the full occupation of Breath, from the base of the diaphragm unto the nose. With the assurance of Ayshshur, the Neúwn leads us into all gates of Light and into the lands of immortality that have no boundaries as those in Metsryim. The boundaries of the Neúwn are the structures of Light alone which are continually expanding according to the measurements of our deeds. How precious it is to do the Túwrahh, for in so doing every Word, the heart of the Neúwn is broadened, and there is no limit to what space of goodness the hand, carrying forth the thought of Light, can shape. For when the eyes are opened, the intent of the Túwrahh is known, and the hand is evermore whitened to fulfill every commandment, statute, and to carry forward with the feet every judgment and ordinance within the Sayings of Light. Accordingly to our hands and our feet the centre is enlarged [Tehillah/Ps 119:32]. At the base of the Neúwn is the Hhuwa, which is the foundation of Breath, that which is blown into the nostrils of Adim that ever links us to the Primal Mind of ALOZAR. For of the same Breath is all Names and none is of an different Breath than that which is given from the Sayings and Words that comprise the Sayings of ALOZAR. And due to this, every Name belongs to a saying or a group of Letters that have within their Letters of Name the structure of the the Mind of ALOZAR. With the Head of the Neúwn, one enters into full explorations of Mind and completely extends every branch unto its fruitfulness, a fruit that does not wither nor fall from its branches [Tehillah/Ps 1]. Thus, the Head of the Neúwn heals the soul and holds the fruit of a Name whereby it never withers or perishes.

The southern head appears first, for consciousness and awareness comes prior to activity. As the Head of the South folds itself back into the east, the light cradles itself into the seat of origins. The Southern Lights do not go further than to the edge of the east, and once there at the border, they fold themselves back into the east, whereby the sun rises and sets in the east. The Head of the Shayin in the west folds itself into the North whereby all that is gathered is brought to the feet of the Queen Neúwn to be discerned and judged as to where it belongs in the consortium of the Lights. The Lights of the West proceed into the north and go no further. For each Light remains in the Kingdom to which it belongs, even as every Name abides within the sides to which they are Named by lineage.

When the Heads unite and crown, the Names are ready to be born through the extension frequency of the Neúwn. Nothing can hold back the birth when the Heads come to the door of the Neúwn. As they pass through the Neúwn, they are called the Offspring of Neúwn, as Yahushúo Ben Neúwn.

The Coming of Meshiyæch, the Order of Melki-Tsedek—Ruler of Righteousness

**Via givings in your Seed of ABrehhem, a complete full stature of your Heads appears. The full measurement of Lives is called the meShiyæch/Messiah as what is in your Seed matures to bear OIL.** Meshiyæch is of the order of Melki-tsedek/Malekkiytsedeq as Knowledge is of the order of Wisdom and Understanding. One comes to the Faces of Melki-tsedek Order by their Seed of ABrehhem that brings forth tithes/tens of Oil in their Crowns. Through ascensions of aligned pairs and their associated thoughts you bear Faces of a PRIEST-KING—**MalekkiyTsedeq**—**one of the Rule of Bayinah (Malek) and the Uprightness (Tsedeq) of Chækúwmah**, whereby Offspring of Bayinah and Chækúwmah derive their priesthood by Name, in distinction to those of the Servant House of Laúwi/Levi which are by lineages. To enter into service and masteries of Malekkiytsedeq, Names and Words are verified within to be in alignment with the Houses of Laúwi as the King-Priest Faces of Malekkiytsedeq. You enter into the House of AHaYæHHAsherAHaYæHH/אָהַאָהַאָהַאָהַאָהַאָ—verifications of YæHH YæHH. Foreigners to this memorial Name and Domains of ALOZAR—hung by Strands of AL to bear AR, their Light, also become members of the Household of Servants and Rulers as their Name distinguishes their true origins. According to your faith—bearing evidence of the InVisible, Offspring of Light pledge to be first Priests/servants and then Kings/masters. The King within a Name rises and sits upon their throne of 12 through servitudes. The Enlightenment of Aharúwan descends within your Name to instruct your members of written and spoken words unto services and masteries. As the House of Laúwi declares the full counsel of ALhhim to Houses of YishARAL, members turn inwardly to adhere to Names and Words of Unity. In hearing, they verify the branches of their inner nucleus of Name to be of the Order of Priests and Kings. The scepters/rods of their branches take their place amongst ruling Lights, affirming the upright ascents of concealed Heads. In designating your spaces for the Lights to abide fully in you, you follow the Path of Service and Authority. You turn toward the Light and away from former shadows. Darkness looses its grip whereby its power of Understanding transfers to your states of becoming in Wisdom.

The priesthood of Aharúwan is not different from the priesthood of Malekkiytsedeq whose is the Fifth Chair of Aharúwan. As the Source of Yehu, all distinguishments of priests—levels of service are in Aharúwan. Those that come from branches of YishARAL, being Offspring of the Queens and their handmaidens, enter into the Court of AHaYæHHAsherAHaYæHH as One Name. Hereby, there are no separations within Orders of the United House of priests.

The Progression in the Name of the Yevusi

Note the letters in progression within the Name of the Yevusi. The Yevusi reads as *the tenth power of the united house structure with authority*. The Name conveys the attainment/אָ with

full development/יג of the Semek/structure/פ, the third level of the ALphæh Bayit grouping of Letters. The Semek, as the 15th letter refers to the full illumination of YAH/אב/15. The final Yeúwd of the Name conveys the level of deeds and activities that we are given to perform by Name. In the Yevusi we sit on the throne, on the left and on the right hand with in Mashiyach; the left Yeúwd and the right Yeúwd demonstrate both hands. This position is for those who have mastered their Names as Alozar, being the offspring of ALhhim. These ten traits or States of Residence are the lands cut out from the midst of our branches, in which we have full occupation and the exercises of Light. The fulfillment of our transformation from a larve to a flying Serif is complete.

Every Name's value reduces to a Number 1-9. When the Number is 1 or 8, the Name belongs to the House of Wisdom. When the Number is 2, the Name belongs to the root level of Understanding. If the value is 3, the Name belongs to the root level of Knowledge. If the Number is 4, the Name belongs to the House of Understanding. If the Number is 5, the Name belongs to the House of Understanding or is a summation of all three houses of Light. If the Number is 6, the Name is a compound value of Knowledge. If the Number is 9, the Name is of the House of Knowledge.

The Yevusi—The Land of Full Illumination/Oyin Head,  
the Sequel of the Girgashi

In the space amidst the AL and the Rayish, the OyinZayin appears. The OyinZayin becomes the body of the United Heads of Light and the Head of the body, being the Oyin, becomes full as the full moon. In this manner the Oyin Body is woven via the threads that pass amidst the spinning of the lights, like a spider weaving a web. When a Seed of ALOZAR is passed from the Laúwim residing in AL unto *the receiving Rayish*, (receiving implicates Mind is prepared and desires the Living Words to reside within), then the Mind is filled with Light as the concepts open and rise. Until the Seed opens within Rayish, one walks in shadows and forms; though seeking Illumination, they do not find it for they are looking at what is appearing before them verses receiving what is within the Nature of Breath to open at their Crown.

One may observe the patterns of the sun and moon; however, until one beholds the sun rising up in their Yeúwd Head, through the portals of Yahúdah, Yishshakkar, Zebúwan, then going—crossing over—into their southern camps at the shoulders into the portals of RAúwaben, Shamóunn, and Gad, unto the far south side of their body, they do not sense the Light of Chækúwmah passing through them each day. As the light of the sun sets within the right side of the loins, it triggers the moon to arise within the loins, coming out of the west. As the moon starts its cycle it passes through the camps of Aparryim, Maneshayh, B'NiymaN and crossing over at the hip into the left side of the body, it continues northward through the portals of Dan, Ayshshur, and Nephethli during the night. The moon then sets in the north of the Rosh/Head unto which it transfers the Principles of Chækúwmah unto statements of Understanding which brings great joy in the north side. As the moon is setting in the north side of the body, the sun is preparing to rise in the east to declare the Principles drawn out through Understanding. Once the sun appears to have set, it continues passing through the portals on the

back side of the moon via which the moon shines upon the faces of those in the west and the north. Likewise, as the moon appears to be setting, it is still conversing within the portals on the back side of the camps in which the sun is passing, triggering the formulation of Understanding within the camps as the sun is striking their faces. This ongoing process then is the cycle of illumination that pertains to the fullness of the Lights in the Yevusi whereby there is no need for the sun by day nor the moon by night, for the Light of the Lamb has arisen from within all of the Heads of the Tribes, whereby there is no darkness.

Via spinning of the threads of Light, the 10 Lands are woven, being the full extension of One/Unity/Achad. Within these lands the camps take up their residence; however the Laúwim, continue to abide within the lands of AL via which they serve camps in the passing of the Lights day and night. The fullness of the Name of ALOZAR is beheld in the Illuminated Mind as the United Names of AL and AR, the KING-PRIEST habitation in the Oyin. Do not think of gender as in humans, for humans are a different kind of thought base, having within them the corruption of the world. For how can a Queen of the Oyin come forth from two males if one would corrupt the thought of the Túwrah by imposing upon it states of mortality? Via the Union of the KING-PRIEST they establish the Order of the Body of Bayinah and the designate the Oyin Body to be the governing force/rule of their Unity.

As one considers the sides of within the Name of ALOZAR/41OŁ4, which side is the Zayin? The Zayin is on the side of the resident Kohen/Priest who lips are filled with Knowledge/Rayish. Via the Zayin, the ALphæh in AL/Ł4 is brought to the Priest forming the construct of thought, AR/44. Thus the Priest is the left of the King as Aharúwan is to the left of maShayh, residing in the chair of Understanding. The Mind of every Name extends itself via the Zayin into the Oyin and thereby submits to the Lammæd rule of the Principle, which has been opened in the Mind of the Priest. The Lammæd rule is the Rod of Instruction in the Hands of the Priest and the sceptre in the Hands of the King. As the Lammæd is next to the Oyin, so the rule is given to the Oyin—The Queen Bayinah, to govern the House; whereas The Queen of the Day—Chækúwmah, governs over the distribution of the Light coming from Bayinah. Thus in this manner one comes to full illumination. The night is of the former until all heads are activated within, whereby there is no night, but one abides by the Light of the SHAYH in which all Heads are activated. The explanation of how *all 8 Heads are in the Shayh* follows in this document.

Bayinah gives the Chayit/Æ as the Neúwn extending itself fully—via 7 Letters/Principles/ALhhim, whereby Chækúwmah appears. The Unity between Bayinah and Chækúwmah is ever secured and verified by 6 spaces amidst the Neúwn and the Chayit—being the ÚWah. As the scepter is passed from night to day, from Bayinah to Chækúwmah, so is the ALphæh passed from AL to AR amidst the Zayin and the Oyin. When the ZayinOyin goes head to tail, the Rayish/head falls to the Zayin/base and receives the ALphæh. This is the procedure for each days Oylah as the Mind is lowered in the midst of the camps upon the altar, whereby all that is beneath it, as the wood/teachings, blood/river of Understanding, and the arranged/assembled members rise up to compose the thoughts in the Mind. The rising of the smoke each day is according to the rising of the base unto the Mind. The transference of the Seed from AL to AR balances the Name of ALOZAR and causes an expansion of the Seed.

### The Building of a House and the Temple of the SHAYH

The passing of the ALphæh from one end unto another is the means that the dwelling states of united Names are fashioned. In this manner **the One of ALhhim creates the heavens with the Arets/Land.** For as there are Names—being a Union of Names known as the heavens, so there comes from the two, one Land or one Body. **In this manner the OYIN-ZAYIN body is composed through the Union of AL and AR. The Oyin Queen is the House of Understanding that is built by the Union of the King-Priest whereby the full consciousness of the OYIN abides in their midst.** In this manner all houses are built and all forms come into being. The means to establishing a tree, for example, is through the ALphæh Principles of Hhúwa-Úwah-Hhúwa being passed/extended from one end unto the other whereby the House of the Seed brings forth a body of its two heads. A machine is formed in the same manner, for as two minds/thoughts are joined, the workings of the united thoughts are manifested in all types of devices. Thus Chaúwah/Eve comes out of Adim/מאד as the Seed of ALphæh/א expands through its foundation/gates/מאד. **The means to expand a Seed results in a form** that appears in the process of the expansion. In this manner, **the Temple of the Everlasting AL is built and constructed, for through the process of expanding every Principle that has been established in the midst of AL and AR, the Temple of the SHAYH/Lamb is built. Through the expansion of the Seed, the full Nature of Breath and the Fire break open in the SHAYIN-HHÚWA Heads whereby the Temple of the Lamb appears, and great is the Light therein. The Temple of the SHAYH is the fulfillment of all that is spoken and then written pertaining to the Mishkan/Tabernacle of maShayh and Aharúwan. There are not two temples, but one; the Temple of the Túwrahh is the Temple of the SHAYH.** The Union of the Thoughts of Breath and the full expansion of the ALphæh in the Mind brings forth the Temple of the Lamb with the Illumination of the Ancient Minds of the Kuwhænim.

I O  
 4 C  
 4

$$(27) 4I=OC4 (29)$$

The Formula:

$$\text{Aleph } 1 + 27 = 29 - 1 \text{ Aleph}$$

$$(28/1) 44I-OC-4 (28/1)$$

A 4 I O C 4  
 44IOC4

The transfer movement of the Aleph is via the Zayin wave from the foundation of the Lamed to the Rayish

As a serpent moves in a wave so the wave of the body passes the Seed from one end unto another, and as the Seed enters into the Breath, it is secured and never lost, but flourishes in the Light and in the good soil prepared and tended to by the residing Kohen. This transference is what is known as casting your pearls before the receiving Mind; for if one cast their pearls to the goyim, then they will be trampled underfoot, being unrecognized. This is how the Seed of YishARAL was lost in Metsryim, for Pharaoh ordered that all Principles of YishARAL be swallowed up in the rivers of Metsryim/flesh wherein their were choked out.

A mathematical balance in the Name of ALOZAR is via ascension of Zayin within the Oyin Head. ALphæh is transferred from AL via Oyin to Rayish via Zayin/Tongue/WordTail Action, the formula of ALOZAR:  $OC\text{X}/29 = \text{I}4/27$  becomes balanced:  $OC/28 = \text{I}44/28/10/1/\text{Achad}$ . When the IO goes head to tail, the Rayish Mind bows to Zayin and receives the ALphæhSeed. The Transfer of the ALphæh occurs through the Oyin Body of Understanding and unifies Paired Names of AL and AR as 1:1. The Values of 11—the Parallel Names are of two Stones is a reductive Numerical Value of ALOZAR/308/11. The balancing of a Name is the active/awakened state of a Name whereby the sides are in the continual flow of Lives and complete illumination. The same may be termed as the joining of the sides whereby all is known within from one end unto another.

#### *Addendum of Dan*

The den of vipers within are the strands of thought, being waves and frequencies of light, yet to be woven into a unified stand. As the waves and frequencies unite, they are known as the serpent that speaks fire through the collective consciousness. Via becoming a whole strand of light, we are woven into the fabric of the Body of Mashiyach.

As to the wave and frequencies of a thought, the wave is of a horizontal flow of Wisdom, Understanding, and/or Knowledge and the combinations thereof as in the Letter Taúwah to form a square or the sides of house. The frequency of the thought is the extent of the thought and moves in vertical, spiral and diagonal patterns. The combinations of the waves and the frequencies are composed of the spectrums of each level of Light and pertains to the areas in which the thought occupies. No thought is without signification and no space is without thoughts. For example, take the ears. The thought wave in the ears is of Understanding; the frequency is of spiral/circle patterns in which we are hear all in the north or south to comprehend all 70 spirals in ALOZAR and the continuum of the properties of Light. The layering of the frequencies and the spirals in the ears are in all members which pertains to their level of residence in the 70 spirals of ALOZAR.

THE PRINCIPAL BECOMES EXTENDED THROUGHOUT THE BODY AND RISES IN THE RAYISH.

The Principals that arise into the Rayish Mind are twelve, being of the 12 Seed types that come from the loins of Yaaqov. These Twelve Principals are within haTsur, the Rock which are evident in the four sets of Numbers equating to Twelve. The four sets of 12 are the full attributes of the 12 bringing forth the 48 centres of Mind belonging to the House of Aharúwan. The twelve primary Seeds are brought forth via four centres of thought that open from amidst the Letters of the Rock, which are formulated in four ways or paths. The first formulation of 12 is the combination of the Neúwn/14/5 + Zayin/7. As the first opening, this path is via the quadrant of the heart, becoming also a section of the mouth, known as Leah. In that the path is of Wisdom, the Zayin joined with the Neúwn, Leah brings forth the first four Names of Yaaqov, RAúwaben, Shamoúnn, Laúwi and Yahúdah. The second path or derek is via Bilhah which is a formulation of the Letters Kephúw/11/2, Dallath/4 and ÚWah/6. This path is the quadrant of the left side of the heart and brings forth the Names of Dan and Nephethi which reside on the north. The third path is the House of Zilpah, as with Leah, the path is of the Zayin/7 and Ha/5 which

brings forth Ayshshur and Yishshakkar. The fourth path is the means to compose and fulfill all things. Born of the formulation of the Neúwn/14/5, Mæyim/13/4 and the Lammæd/12/3 are the Names of Yúwsphah and B’NiymaN from which comes Yahushúo Ben Neúwn and the 70 Names of Light into the lands of the Oyin. B’NiymaN, being the 12th Name is the twelfth house which is the Seed from which all twelve come. In B’NiymaN we see the Order of AL, the Lammæd of the ALphæh. According to the paths of the Seed, so are all kokavim/stars and planetary bodies arranged in space, the great fields of Light that go out from the midst of the twelve centres.

The Name of AL/ℳ is read as the twelve houses/Lammæd of the Seed/ALphæh that comprises the Word of ALhhim. These Twelve Seed types are the fruit of the Rock, coming from the Stones of Maneshayh. Each Seed is appointed for the quadrant of the heart, which opens unto the mouth, and forms not the natural, but rather the Word State of Consciousness via which the immortal house of YæHúwaH is built. Each side of the Seed is nourished to bring forth its glory and wealth/tithe for the House of YæHúwaH. Thus we are to read a word from all four sides to discern the formulation of its origin, its ability to expand/reveal, to be woven into the fabric of our thought consciousness, and to behold how the Word forms the lands into which we are entering. We speak the word according to Wisdom, that is from right to left, whereby we speak according to the origin of the Word coming out of the Head of the Neúwn. Though the Letters of the language of the Oovriim/Hebrews are given left to right according to the giving of The Neúwn, each word is spoken right to left. The language of the Oovri enables us to transfer into all States of Mind as ALOZAR transfers the Principles from one side unto another.

Every plant forms itself a head for the grain/seeds to be gathered. The seeds gather at the heads of Understanding and Wisdom that arise through the stalks. The stalks depict the House of Laúwi, which are in the midst and via which all Names ascend unto mastery. The fruit of Knowledge form within the fields of Names as they receive the lips of the kuwhænim. As the heads are formed within the Mind, so comes the blessings and glory, whereby the entire House of YæHúwaH overflows with the tithes. For until the heads are formed and the fruit and the seeds appear, one has not the wherewithal to pay their tithes into the House of YæHúwaH.

As a plant forms itself a head, so the new generation of the plant is born from above. This is the meaning of Yahushúo’s saying to Nicodemus: “You must be born from above.” The birth below is through entering into the womb—that which is beneath. The new birth is via entering in the Mind, that which is above. If we enter into the womb again, we remain in the watery graves. The womb is the gate to descend into sheol—the watery grave. Out of the waters of Metsryim we rise with the bones of Yúwsphah, via which we find the way to the Lands of the Kenoni. The contact point and connections with the Lands of the Oyin are through Yúwsphah. Via selling Yúwsphah unto the House of Pharoah of Cham, connections from Kenann to Metsryim are laid. Marking the path is likened to one making a path in the forest. From the lands of Kenoni unto the House of Pharoah, the trail back home can be found. We come into Metsryim, and we arise from Metsryim via Yúwsphah’s bones. We come and go according to the everlasting bones of Yúwsphah that do not decay nor weather, but stand firm against the winds and the waters. The bones are the inner whitened structures that do not dissipate and



thus keep the records of the North from which all thought breaks open into the Qadam to reveal the origin of thought. Out of Metsryim we arise to be born from above.

Entering into the womb is the sheol/the grave. **The path of redemption appears by the guiding rod of Aharúwan that meets us in Metsryim and begins to read to us from the mouth of maShayh.** According to the pointing of the rod, as the right index finger, the enlightenment of all that is within us gently points us to the paths of freedom in which is the mastery of the Yevusi. As we listen and walk in accordance with the first born of ALOZAR, all of the camps of YishARAL know their Origin. **As the priest speak the messages of ALOZAR, those of YishARAL recognize the ALphæh Principle being spoken and follow thereafter.** As the rod of Aharúwan is placed over the waters, *a path of dry land is formed to walk upon.*

- 1). We extract from Metsryim all properties of Light and carry these properties of thought forward into the wilderness stages [פּאָד].
- 2). There is no stage that can be skipped over. Each stage of the journey is an encampment in the *Midrashim of The Word/HaDavar* [օֹד].
- 3). When we speak of the The Word. we are referring to the Teraysarun/יָרֵאֵל Foundation/Δ of ALOZAR that passes though the Oyin Body/גּ unto the crowning Mind/4. The Teraysarun provides channels for the Words to be transmitted. Each house is a gate for the Words at that level. [גֵּ].
- 4). The Word/Davar/4גּ is a perfect formula of thought arising from the Rock, being the sum of 8. Words are formulations of Seed that have opened whereby the Principle is developed and expressed in the Mind or via Thoughts [רֵד].
- 5). The formula of the Word is: Dallath/4 = Bayit/2 + Rayish/200/2 or 4 = 2 + 2. Or as we compute the parts within the Letters, Dallath, being of 8 parts = the 4 parts of Bayit and the 40 parts of Rayish: 44, which reduces to 8. The Word of YæHúwaH is 8 + 8 = 16/O/The Oyin consciousness. Through the wilderness stages/4גּ, we study and enter into the Words of the Oyin Lands [פֵּ].
- 6). Each level of study takes one into the State of the Lands. **The course way of 33 steps is passing under the Rod/Lammæd/Instruction of the 3 Houses.** The value of 33 is the Teachings of the third house of Light—the Laúwim which appear in the third offspring of Leah, conveying that the Names of the Laúwim are the patterns of the Mishkan. **Though they are the firstborn of ALOZAR they appear in the third position, for through them the Heads of Light appear—those of Wisdom and Understanding, which are filled with Knowledge in the bearing of YishARAL** [אָד].
- 7). As the ALphæh is transferred from AL to AR, the priest and Laúwim accompany the Principle, and thus they come with the House of YishARAL in all states of their journey. With the sheep are the shepherds of their souls. Should one falter to understand in one course, they must continue in that course until their understanding is full whereby they may proceed unto the next course. Should they go forward without understanding, they will not find the quench of their thirst; and hence, the mouth will be dry and unable to find the wells in their sojourning. They must go back to the prior level to insure that

they are prepared for the next course of study. The material in these writings is sequential unto the goal, and though there are seemingly thoughts being reiterated, the thought, as it progresses, is now coming in combination with other information whereby there forms a construct of thought relative to the course of study [WYI].

The Oyin lands is our inheritance in *ALÖZAR*, for in the Rings abide Offspring of the Rayish. The inheritance of *ALÖZAR* is designated for the Seed of AL. Through words, we formulate the Worlds of Light whereby all that is made, being a formulation of thoughts, is made from that which is nothing—without form, being invisible, holding on to no flesh or matter, yet is the means by which all things unite and have being, shape, color, and faces. Though the 33 courseways, we build the Mind's dwelling into 8 united and indivisible Heads of Light, interwoven with cords that cannot be broken, like a Rock. All thoughts are summed up to be HaDavar, which is within the Mashiyach Mind that fully communicates *ALÖZAR* and makes know the Divine Order of the Laúwim and the Houses of thought via which the Mishkan of the Word is built.

In the Name of *ALÖZAR*, the Twelve Seeds pass from the AL/ŁŁ to the Rayish/4. The transference of the Twelve is the pattern of being born of *ALÖZAR*, as one that comes forth from the Rock of their foundation. Via the transference, the lands of the OyinZayin IO break forth from the midst of the paired Names and their continual givings fill the Lands with the Twelve Seeds, which being extended, is the inheritance of those of YiSar-AL/ŁŁ—The Twelve.

According to the sowing of the Seed, so comes the rains. With the sowing of the Seed is the water which causes the Seed to spout and to take root. The sowing of the Seed brings with it the first or sometimes called the former rain. The first rains are those in the spring, during sowing, in the month of Yahúdah. The last rains are in the fall, during the harvest, in the month of Aparryim. The later rains may be depicted as the breaking of the waters whereby the heads of Light appear. The Union of these Eight Heads are the story of Núwach, a story for the end of an age, for as in the days of Núwach so shall be the coming of the offspring of Neúwn (Son of Man).

### The Name of *ALÖZAR* and the Making of the Ten Lands & The Baptism of the 8

**The coming of the Eight Heads to enter into the Tavah/Ark is through comprehending what it means to dwell in the lands via the Name of *ALÖZAR*.** In the midst of the Name of *ALÖZAR* is the Oyin/O, and those receiving the Seed of the Lammæd are saved by water. For as the ALphæh/1 + the Lammæd/12 = Mæyim/13, thus those receiving the Seed into their heads are saved by the transmission of thought, which are the **Mæyim/Waters of baptism** [ALphæh Kayphah/I Peter 3:20-21]. The Mæyim/waters are the distillations of Breath that are imparted to us via the Rod/Instruction of Light which are to us *the Waters of Regeneration*. As one is immersed, their eyes are opened as the Oyin, and they come into the Tavah—into the midst of the counsel of the 70 which are in the midst of *ALÖZAR* and whereby all things are governed by the All Seeing Eye.

The Zayin/I at the left of the Oyin: 4IOŁŁ, is the base of the Oyin. Together with the

Oyin, the Zayin and Oyin multiply/increase as in the formula  $70 \times 7 = 490$ , for when any head and base are joined, multiplication of thought flourishes. As the Oyin is the value of 16, with the reductive of 7, it is discerned that  $7 \times 7$ , being 49 or 4 and 9 is a reductive of 13, which affirms that the Lands are of the same value of Understanding as the Name of AL/ℓℓ/13. Therefore, at all times, one dwells in the spaces that are according to the Instruction of ALphæh/ℓℓ, and apart from ALOZAR there are no dwelling states nor does one have being. The Letter Rayish comes from the Lands of the ZayinOyin which reveals the Heads/4 that emerge from the 13 camps. The value of the Heads is 20, being a full extension/Yeúwd of the body of Understanding. There are 10 Bayit in the Rayish, which corresponds to the 8 Heads of Wisdom and Understanding and the 2 Heads of the Priest and the Melek/King. The 8 Heads arise upon the bodies of Wisdom and Understanding. Each Head, having a Bayit, the 8 Heads ( $8 \times 2=16$ ) convey that they are of the Oyin/16, the full counsel within the Name of ALOZAR. The Number of the Oyin/16 is within haTsur/the Rock, being the four sides of each Letter of the 8 ( $8 \times 4=32$ ). The value of 32 is the sum of the parts of the Oyin.

The Numbers that comprise the Name of ALOZAR, being of the value of 11/Υ, express the Centre of all things, as the Letter Kephúw is in the centre of the Letters. Via the Union of the pairs, AL and AR within the Name of ALOZAR, there is a multiplication of thought as  $1 \times 1=1$ . The Values of ALOZAR are AL/ℓℓ/13 + the reductive of OZ/ℓℓ/13 (see paragraph above:  $7 \times 7$ , being 49 or 4 and 9) + R/4/20 which are summed to be 46/Υ<sup>™</sup> which is the reductive of 10/1. The value of 46 is the sixth column of the Letters: ÚWah/Υ and Mæyim/™ which culminate in the Rayish: Υ<sup>™</sup>4. Within the Name of Mastery two Names are joined/Υ through transmissions/™ whereby they are One. The State of Oneness is the State of Mastery in which the united Names are blameless and proceed in love towards all. In the State of Oneness there is no deception nor enslavement; however, when the State of Oneness is not achieved, the heart is left open to suspicions and divisions and closed by secrecy whereby Names are overthrown by every attribute outside of perfect Union. It is through division, jealousy, strife, and secrecy that the House of YaaqovAL/Jacob became overthrown to reside in slavery, for what was in the midst of the members/brothers became evident in the selling of Yúwsphah, and from the secrecy came forth lies and famine. As the Numbers in ALOZAR are counted in Understanding, the values are reduced: AL/ℓℓ/13 is 4 and OZ/ℓℓ/13 is 4. Rayish, having received the ALphæh form the Hand of AL is AR/44/21 is 3. The sum of the Letters in ALOZAR is 11/Υ from which all branches of thought flow. **The land carries the frequency of AL via which it is made, for the space between ALphæh and Lammæd is 10, whereby there are ten lands.** The frequency of the lands is according to the Instruction/Lammæd of the Seed/ALphæh, and when the lands are not according to the LammædALphæh/ℓℓ, inhabitants becomes hungry, for there is nothing for them to eat if they eat not Seed of the Rod/ℓℓ. However, as the Seed is received, lands bring forth every trait of the Name of ALOZAR, and lands are filled with abundance.

### The Acts of the Ones of ALHHIM

From AR/44 comes the word, AUR/4Υ4, meaning light; for when the Mind receives the ALphæh Seed, the Seed opens and there is Light [SMB/Gen1:3/Tehillah 119:130]. This is the Light of the first day, which is the primary work of the ones of ALHHIM. Light is the result of being joined through transmissions, from which the firmament/expansion of Mind of ALOZAR

occurs. With the passing of the ALphæh comes forth six days—the expansion of the firmament in the midst of HaMæyim/מַיִם/waters of Breath, the Base of the Neúwn, unto bringing forth the Adim—the paired Names of Light in which there is joining/marrying and the giving/extension and receptivity within the joining, in which resides all thoughts of Fire come to reside. The translation of Adim to be male and female conveys that within One Body of Names there are pairs which branch via the Zayin and reside with dominion/Quphah. **Within Adim are the giving unto knowing coupled with the receiving to unfold and extend the Principle unto mastery—the Yevusi.** This residence of Adim, being a composition of fiery united thoughts, is the Mishkan or Tabernacle of YæHúwaH from which comes the saying, “Know you not that you are the Tabernacle of YæHúwaH?” The pairing of Names is likewise stated in the account of Núwach whereby the Names enter into the Tavah/the ark. According to the activity of Núwach and the Eight of Noah’s House, so is the coming of the Offspring of Neúwn. In the acts/days of Núwach there is marrying/joining of pairs and giving within the joining of Names unto entering the ark [Mattithyahu 24:37-39]. The entrance into the tavah/ark is the same of entering into the shavbeth/rest or the entrance into the Lands of ALOZAR, or the entrance into the Mishkan through maShayh—the drawing out of the Lamb.

The Word of Knowledge of the five Letters of 4IOÇ4/ALÖZAR are One, Twelve, Seventy, Seven and Two Hundred, being the sum of 290/11 the Heads/4 of Truth/Totality/⊕—the Circle of the 4 Faces and the 4 Sides of the United Teraysarun, or one may read the Values as One, Thirty, Seventy, Seven and Two Hundred, being the sum of 308/11 to convey that within the Name of 4IOÇ4/ALÖZAR is the Fire of the Eight/haTsur/The Rock.

The Name of AL/Ç4 is the Foundation of the Heads of the Yeúwd and the Shayin. As we behold the results of the givings within the Union, the Heads appear:

Wך.

In the midst of United Heads of Qadam/east and Yam/west is the Letter Yeúwd whereby two heads of Understanding dwell within the Fire via givings of the ALphæh unto Totality:

(21) W כך 4 (10+10+1=21).

As ALphæh is given to the Rayish, the ALphæh Principles multiply and ascend to the head of the body as seeds rise upon the head of a plant. As a result, the head is bronzed. As the Principles/seeds arise, the Mind speaks according to the foundation of AL as King-Priest of ALOZAR. In this context of being joined, we examine all teachings and doctrines as to their foundation of ALphæh and Lammæd.

The Yeúwd is the Rod of Aharúwan that buds. By the budding of the enlightened mind comes forth all mature concepts, depicted as almonds. Each mature seed has 4 sides, and from the maturation of the House of Aharúwan, come the four defenders of the faith: Nadæv, AviYahua (Avihu), Alozar, and Ayithamar (Itamar). Out of the Yeúwd comes the Oyin, for from the doing the deeds of the instruction comes the full consciousness of all within. With the Oyin consciousness comes the Lammæd unto the Shayin, for how can one walk or proceed unless the eye is opened. For until the Oyin arises a man stumbles like a drunk or one blind. As the Oyin forms to any degree, so one has access to the Tree of Knowing, and from the level of Knowledge, one beholds the gate of the Neúwn from which all activities/days of the Lights

come and through which one enters into the worlds of Letters of ALhhim. For in that there are twenty-two Letters, and these 22 being four squared (22/4), so are therefore the worlds of Light that are formed via each of the pairs of Letters. Within the worlds of the Letters are the squares of the cube, being 96 squares per side, a total of 192, which reduces to 12 according to the pairs of the Letters.

Out of the conceptual Seed, as it branches in the Mind of YaaqovAL/Rayish, all 12 teraysarun of thoughts come forth as the inheritance—the possession of ALOZAR and the priesthood. As the branches of a tree are the inheritance of the roots, so are the people of YishARAL the inheritance of the Name of ALOZAR. Thus, that which has been sown in the AuR/Light realm, is possessed by the sower. When Yúwsphah is known as the ruler of the Land, the people become redeemed from famine, whereby all property of thought becomes the property of the priest and Pharaoh, and none is left unto itself to perish. Thus all Names are redeemed by Aharúwan and ALOZAR, and none shall perish; for ALOZAR comes forth into the mountains and valleys to seek out the sheep and rescue them from their wanderings [Yechezqel/Ezek 34:11ff]. The meaning of ALOZAR coming indicates that the Thought within the centre of the camps swirls out, extending from the centre unto the uttermost realm of YishARAL, and rescues the lambs from harm which are in the outer rings/pastures.

The tongue speaks with the consciousness that is in the midst of the upper waters whereby all in the lower waters may be read and also watered with words coming down from the mountain/head. The penile gland, being the head in the lower waters, gives the Seed that rises and expands unto the midst of the upper waters. This continual flow and exchange of waters is the means of renewing the mind and maintaining the Unity of all that is at the roots with the branches of Knowledge in the upper waters. *In the broad sense, this exchange process is the activity of Life that establishes a State and causes the State to flourish with the abundance and fruit of the Lights.* The results is called “the abundant life.” **The exchange process is occurs at every level between Names** as well as between the clouds of the skies and the bodies of water beneath. *In all levels of life there is a symmetry* via the mutual givings of the sides. The lower waters rise and the upper waters fall to bless the inhabitants. This is the on-going exchange of the two ends via the eternal bonds of the AL and AR. Via the exchange process the Earth is formed and clothed with the garments spun during the circling of the Lights around the Earth. In the midst of the Heads, the space that is in the midst of the ends, is the OyinZayin dwelling.

As Aharúwan rains upon the spaces within the Garden of YæHúwaH, the pools of Wisdom are formed beneath in the King’s Garden. The Garden is called after the Kings, for in this Land of AUR (Ur), all kings come through Avrehhem [Sepher MeOShah Bereshith/Gen 17:6]. In this space the scepter of Yúwsphah rises with the branch of Yahúdah haMelek, the two being one stick/rod that oversee all lands of AuR/אֶרֶץ according to the lands of AyL/אֵילָן in which the House of the Priest reside. In AL the Rod of Aharúwan buds and bears the ripened Principles, and plenty is the fruit thereof of every kind. For what is sown in the Kings Garden, that being in the loins, rises in the Head of the Priest as the Rod of Aharúwan. The King gathers from the Priest the sweet drippings of Knowledge within the founding basin of the Teraysarun. In return, the King in the Garden provides to the Priest in the Temple the abundance of the fruit. In this way the Keyor/laver of the Mishkan is built and filled with fresh waters. Out of the pools of the

Keyor/laver, known as the Pools of Shiloach/Siloam within the King's Garden, arises the first generation of Names coming from the Rayish [NehemYah 3:15]. In the first rain of the Priest comes forth Avrehhem with the joined Principles/Seed within the Name of Abram. As the Seed of Aharúwan/ך is transmitted to the Rayish King/ך, the Land of AUR/ךך is formed. From the loins of Abram in AUR the entire House of Knowledge rises through Understanding and takes up residence in the OyinZayin Body. The Name of Ab-ram/מךך is composed of the founding ALphæh/ך of the House/Bayit/ך—the Body of the OyinZayin/IO. The ALphæh in the Name of Abram is in AL/ךך of ALOZAR that is transmitted to the Rayish/ך for expansion/מ. Through the transmission of the ALphæh, both ends of the King-Priest scepter are united. The union of the upper and lower waters/מ bring forth the abundance of Knowledge to fill the Earth whereby no sin or violation can enter. The one having the Seed of ALOZAR within them cannot sin or default from the full extension of ALOZAR, just as a peach tree cannot produce a fruit other than the its Seed base. Sin is only possible when there are thoughts occupying a space that are not of the ALphæh Lammæd Seed of ALOZAR. Those without the Seed and its opening, operate in ignorance, being devoid of the Knowledge of the Túwrahh and hence, without the deeds/extension of hand/Yeúwd Head of the Túwrahh [Yeshoyahu/Is 42:24; I Yahuchanan/Jn 3:4].

The birthing of Abram and the Seed within the Name of Avrehhem comes from the AUR/Light/ךך. The House of Avrehhem is the birthing of Light as a result of the Union or the ALphæh with the Rayish. The Túwrahh states [SMB/Gen 1:3]:

ךך זאזז זךך זאז מזאזךך מךךזזז

which being translated: “*The One of ALhhim considers to give/extend the right hand—the ALphæh Principle of Light; as one gives to extend the right hand, there is Light* [SMB/Gen 1:3].”

The construct of the words, זךך זאזז, that is repeated in this line of Túwrahh, denotes that the Head of the ALphæh, that being the Yeúwd/ז, extends the Principle via Breath/א, the base of the Neúwn, whereby there is the giving—the extension/ז of the ALphæh/ך within the Rayish. **The giving and extension of the ALphæh is Light.** The ALphæh is opened by the Breath/א at the neck/ז whereby it rises into the Rayish/Head.

The Light is ALphæh extended by the right arm—the hand of giving and the hand of blessing. Light is an extension of singular Principles that are opened in deeds and extended into the Rayish/Knowledge of Unity/ז. Or one may say that Light is the joining of ALphæh Principles in the Mind through Understanding. As the Zayin/tongue speaks of the giving or as the Zayin/penis gives the ALphæh for unfoldment in the Rayish, the ALphæh breaks open, and there is Light/Ur/ךך.

*As to the anatomical corresponding parts of the body with the Letters that are mentioned in this article, the reader should comprehend that all parts function in all Names and is not restricted to gender nor to form. The form of the mortal is not the design of the immortal just as a worm is not the form of the butterfly. Yet, seeing that the form contains the ALphæh, we know the design of the immortal is present—yet to appear and break open from these shells. In that a seed has the complete tree, we know likewise, that the ALphæh of our Names united, as HhúwaÚWahHhúwa, will bring forth the complete manifestations of the Teraysarun dwelling.*



‫:וַיִּזְעַק אֶל־יְהוָה אֶל־נֶפֶשׁוֹ׃

which being translated: “*The One of ALhhim considers/thinks/‫מַחְשֵׁב אֶת־אֶרֶץ הָאֲדָמָה*  
*causes to transform/emerge/‫אֶת־אֶרֶץ הָאֲדָמָה לְהֵיוֹת לְנֶפֶשׁ חַיָּה*  
*to become a soul/animation of life—a “living soul”/‫אֶת־נֶפֶשׁוֹ׃*  
*—to function/portion out through humming/moaning/yearning/b’hamah/‫אֶת־נֶפֶשׁוֹ׃*  
*coupled with slithering creeping movements/showing progression/remesh/‫וּמְשָׁחָהּ׃*  
*and with the living deeds composed in the unity of the Earth—within the united OyinZayin*  
*Body /‫אֶת־נֶפֶשׁוֹ׃*  
*and with the activities of Light extended/‫אֶת־נֶפֶשׁוֹ׃, the one is verified/to be the Branch of the*  
*Neúwn/‫אֶת־נֶפֶשׁוֹ׃.* [SMB/Gen 1:24].”

Results of the latter rain provoke thought to emerge through the OyinZayin lands. The three steps of portioning out/classifying how all things comprise one, commonly called “after its kind” occurs within the OyinZayin Body upon breaking out of Metsryim. “*After its kind*” pertains to being after the *damuth*/likeness of ALOZAR and the classifications of the paired ALhhim. We are not portioning out our Mind to be according to the natural/flesh body. There is no fifth day in captivity because all of the works of Light are halted as the Seed is held captive by the flesh. The days/acts of Light occur as one is liberated from Metsryim, and the House of Yúwsphah is carried beyond Metsryim. Thus the guides out of captivity, must be those who have become liberated. The liberators are maShayh and Aharúwan, who had left Metsryim, whereby they may lead the members out of their confinements unto the Earth of ALhhim—the Ten Lands.

With maShayh and Aharúwan is the Name of Yúwsphah—one freed from the prison of Pharaoh. Yúwsphah carries the structure of thoughts to proceed from Metsryim to Kenoni whereby the living souls come to bear the fruit of the loins. Yúwsphah, as the penile organ, is attached to the bones in the west as the west is attached to the bones of the north. In this attachment to the North, the routes from Metsryim to the sides of Kenoni are found in the circling head of twelve points. As the west is attached to the bones so is the the Shayin/W attached to the Lammæd/bones/‫. In the Name of Yúwsphah/‫ there are no roots in forming the stature of the Name, but rather a trunk/stalk/‫ and the fruit/‫. The roots of Yúwsphah are in Daúwd with Yahúdah. The Name of Yúwsphah contains the Head of the Yeúwd/‫ —the extension of the ALphæh to the 10th power, whereby one structures the faces/‫ according to the Shayin/crown—dwelling of the Shekinah.

The construct of the words, ‫אֶת־נֶפֶשׁוֹ, *Nephesh Chayah*, conveys that the throat of the Neúwn opens to bring forth a transformation to become a *living soul*. The faces of the soul are brought forth by the Shekinah Breath whereby there appears 8 extensions/‫ of Breath/‫—‫אֶת־נֶפֶשׁוֹ/the Chayah. Chayah are 8 ascendance in souls depicting the 8 offspring of Núwach. Note the interplay of the Letters Neúwn and Chayit in these constructs of Letters. The term, Chayah/‫, carries the thought of 8 extensions of Light; each extension conveys a kind or classification of thought. **The liberation of the ALphæh, which is also the opening of the ALphæh occurs via the humming/music/meditation of Breath coupled with the slithering movements of the serpent/pulsations of thought, unto their full activation into deeds whereby the 8 become evident.** It is the slithering movements of the ALphæh through Zayin whereby Names



extend through their Unity unto the Heads. The translation, “and it is so,” is best understood that formulations of Light bring forth the evidence of AL/ℓℓ.

**The living souls are then those fully awakened.** The 8 Heads are extended to the 10th power in that each base rises and appears in the tenth Letter from the opening Principle. Through the empowerment of the  $8 \times 10 = 80$ , the Paúwah/mouth/80 of the Neúwn/50 speaks with Fire/Shayin/300—becoming a living/אֵלֶּיךָ soul/nephesh/נַפְשׁוֹ. Thus in the Letter construct, Chayah, the Chayit/8 are extended by the Yeúwd/10 according to the Knowledge that emanates from the Ha/Breath. Thus upon the Head foundation of the ALphæh is the Head of the Yeúwd. Upon the Zayin is the Oyin. Upon the Lammæd is the Shayin. The Head of the Neúwn sits upon the Ha. In that each crown and base are joined side by side, there are 8 Heads that comprise a living soul upon the foundation of the square, whereby two squares are joined to comprise the cube. The four squares, each being a multiple of 4 parts in the base and 4 parts on the side, comprise 16 parts within each square. The value of two squares is  $32/5$  for each side—HhúwaÚWahHhúwa—the union of the sides of Light, or  $64/1$  counting both sides of each square. As the sides expand to release the 8 Heads through the drawing out of Understanding, six sides of 96 parts become evident whereby the united squares are filled with Knowledge. The 96 parts are the empowerment of the 8 within the 12 or  $8 \times 12$ . In summing up both sides of two Names, a sum of 192 parts or a reductive value of  $12/ℓ$  rises via which there is a mastery of the Lammæd/the rule over all things [SMB/Gen 1:26-28]. The value of  $192/96$  may be read as the Dominion of the Liberted Pairs.

### The Latter Rain of the Rayish Mind

ALphæh is the foundation of the former rain which provides the means to sprout the Seed. The former rain is the initial enlightenment that opens the Seed Principle to emerge through the waters. In this period is the opening of the mind through the opening of the body spaces from the Zayin to the Rayish. During this outpouring of thought from the Mind of ALOZAR, the House of Avrehhem and the connections amidst a Name and its surroundings is established. The surroundings are those of Cham and Yapheth which are the means to define what is within/Cham the Seed of Shem that is opening and the means of expanse/Yapheth. According to the progressions of Shem so are the progressions of Cham/definitions and Yapheth/expanse. When the attributes within a Seed are suspended or become static, likewise are the manifestations and expanse of breadth halted. However; when the Seed is growing in the Light, the form and the breadth grow also. Hence, for us to proceed beyond the level of Metsryim, we must grow the NAME of SHEM whereby the former boundaries are cast off and the Inner Construct of the Seed may flourish under the later rains.

During the first rain, the Seed opens in Abram and extends unto the twelve of Yaaqov. The latter rains causes the Seed to grow out of Metsryim, beyond the veils of mortality, and expand into the Lands of the Oyin—the lands of our inheritance which are formulations between the ALphæh and Rayish. In entering into the ten lands, the power of ALphæh is expanded to the tenth power.

The latter rains of the priesthood of Aharúwan are greater than the former as they usher in a whitening within all nations in which the Seed of SHEM sheds its former skins and weaves the

garments of ALOZAR. The latter rains are greater in that they exceed the former growth. Through the later rains, the Houses of YishARAL rise into the upper Oyin State upon the established base of the Teraysarun of United Names. As Abram comes from Ur, the Names come with the descending thoughts of the priesthood whereby the illumination and the former rain, with the Seed, bring forth the twelve branches of thought into the lands of the Kenoni. The branches receive no rain in the Kenoni as they strive for self-recognition and honor from others.

In the days of the latter rains, the rod of the priesthood becomes activated in all nations into which the tribal thoughts have been scattered as one scatters the seed upon the ground. The activation of the rod goes full circle to lead all minds unto the Centre of the Neúwn whereby they cross over into the Lands across the Yordan. As the Rod of Aharúwan bears the mature ripened almonds in the House of Aharúwan, so shall it bear the same in all peoples.

The latter rain is both of clear water and fire which both enlightens and purifies the minds and members of a house. The latter rain is the baptism of fire that falls upon the inhabitants and in all realms that are yet attached upon the supremacy of Baal and the kingdom of Babylon the great. In burning up the lust of the eyes, the lust of the flesh, and the pride of life, the Consortium of YæHúwaH arises upon the ashes of the fallen cities. Those of the Light walk above the thoughts of self-recognition, division, and diversions from the Light.

Mind receiving the Seed is the foundation of the latter rain whereby the ALphæh multiplies in the head whereby the Knowledge of YæHúwaH reigns from one end to another [Mishneh Túwrah/Deut. 11:8-14; YoAL/Joel 2:21-32]. In this manner, all four quadrants of the Mind expand unto the full counsel of ALhhim. Via the giving of the ALphæh and its transmission with HaMæyim, days 1-3—being the first giving of Light, there are the former rains [SMB/Gen1:3-13]. Via the expansion of the ALphæh unto the crown with HaMæyim, days 4-6, being the second giving of the Light, there are the later rains [SMB/Gen1:14-31]. The activities of days 1-3 are according to the first rains; the activities of days 4-6 are according to the latter rains. Rain accompanies the giving of ALphæh, whereby there is Light. Without the waters—the distillations of Breath, there is no giving or transmission. Clouds formed without waters are without the Seed and the waters of Understanding.

The first rains bring forth the Heads of the Oyin and the Yeúwd; the latter rains bring forth the Heads of the Shayin from the base of the Lammæd and the Neúwn. The latter rains yield the total/Taúwah/22 harvest of the branches, from the ALphæh/1 with Shayin/21 or the Principle with the Shekinah. The latter rains are 40 days and 40 nights, each being of 80 parts which yield the value of 160/16/Oyin. Núwach is the age of the latter rains whereby all Names enter into the *Tavah*/Ark by pairs.

The 8 souls of Núwach are the 8 characteristics coming out of the Rock. In the Name of Núwach there is the giving of the Neúwn to the Chayit, whereby comes the eight foundational expressions of thought. The 8 souls convey the union of two Teraysarun, 4 + 4.

*The Names of Núwach: The Neúwn/14 to the Chayit/8 = 22/4.  
The Names of Yapheth: The Yeúwd/10 to Paíwah/17 to the Taúwah/22 = 49/13/4.*

*The Names of Cham: The Chayit/8 to the Mæyim/13 = 21/3.  
The Names of Shem: The Shayin/21 to the Mæyim/13 = 34/7  
The reductive sum of the Names is Tsade/90/18—  
the full extension of the Branches in Liberty or the Yeúwd/Activities of the 8.*

1). The latter rains come down from the head in the houses of Núwach. As they are united two by two, they enter into the Tavah/the Universal House of Life—the ark. 2). The former rains stem from the ALphæh and cause the Seed to Open into the Mind of Avrehhem. As the Seed is given to the Rayish from AL/℄, all is given from the Houses of Wisdom and Understanding in ALOZAR unto Knowledge. 3). The latter rain falls from the Mind upon the members of one's household—YishARAL to affirm that they are of the nature of ALOZAR. The second or latter rains begin as the pairs enter into the Tavah/ark. These rains lift us above mortality and the dominion of the world. So be it. Thanks be to ALhhim.

### Walking upon the Ashes of our Enemies

The Yevusi State proceeds to overcome every enemy to the Order of ALOZAR. There is no seeking to appease the flesh nor to enter into an agreement with the processes of thought relative to forms or the avenues of expanse/chakras. For that which is of the flesh can never be justified before or in the Faces of ALhhim, for the flesh is deviant from the Faces of Light.

Though one may seek to reconcile the past or past mistakes that are done in the flesh, the flesh nor the deeds of the flesh can be reconciled for they belong not to the Mind of ALOZAR. There is no sin offering for the works of darkness nor is their forgiveness what has been done in the flesh. Those who continue to sin with the flesh or with their members remain in darkness without the Seed of ALOZAR. Those seeking forgiveness of their sins and teach others the same are entangling the mind and members with their faults and keeping their hands in contact with the violations. The words of the prayer are to FORGIVE US of our sins/violations/waywardness and to FORGIVE THOSE who violate us. In forgiveness we hold not our Name nor members nor another into states of outer darkness.

Forgiveness is granted to our members for their violations which follow after forms of Cham to seek dominance of expanse through Yapheth for the Members, causing a striving within members that upset their equality. These Members, called by Names, are forgiven when they return unto ALOZAR, in that they have been born of the Rayish, and will not be forsaken by ALOZAR nor allowed to perish, for how can ALOZAR destroy the UNITY of which all Lives belongs? In being **Faithful to the covenant** made with your Name from the beginning and **Just to align you to their Faces**, YæHH does not know nor recall your sins (1 Yahuchannan 1:9). Your Name of DæuWD will not see corruption, for it is ever bound to the Incorruptible (Tehillah 16:9-11; 17:15)! If one Name is destroyed, then Unity of wholeness is marred. Flesh and deeds of the flesh are put to death/destroyed/consumed by FIRE within the Tongue of the Serpent.

One discerns how their members are used and how they are moving into the realms of Light or how they are remaining in the houses of bondage. Use of the members, according to the ruling Queens of Light, is the daily set up of the oylah/ascension offerings. ***When the Head remains on the altar, the Mind stays in tune to what the members are doing and what thoughts are process-***

*ing*. The Mind, on the altar, is in the Fire and knows therefore details and activities of each Day/Night as well as the works and progressions being made through an offering.

Reconciliation with ALhhim pertains to our Name and the house of the Names.

Regarding the House of Names, these have been written within the Scroll of the Lives, commonly called the Lambs Book of Life, eons ago to be brought forward in this age. They were sealed up for the time of the later rains of the priest. These records of the Lives of the Names are carried as the ark is carried forward where ever the Priest leads. In that we are in the fields of the flesh, the records are carried by Qahhath within the seals of the wax/flesh fats and are at the sides of the Priest. These seals have been broken, and the flesh cannot continue to hold back the revelation of all Names/positions of the Light. The Lamb's Book of Life is the record of the Names of LIGHT which is written within AL by the Kuwahren/Kohen. As a Library of details, these writings are for total recall and bringing forward the records of Light. In these records are the words of Light, from which come the works of AL that pertain to each Name. Thus the scrolls are of the Names of Life.

### ***The Fabric Loom of the Heads of The Lamb/HhaShayh/26/8***



The Lamb's Book of Lives

Literally, the Lamb's Book of Lives is translated from the Oovri/Hebrew phrase:

אָװל אַװאַלעװענע אַרױס

**“With the Scroll of the Living Ones, one verifies/affirms the SHAYH/Lamb.”**

According to the words of the Lamb, one verifies and becomes aligned with every concept/seed of ALOZAR that is transmitted to the mind-priest. In this manner, they are for the Shayh/Lamb and war against the harlot [Chazun/The Revelation 17:14;19:19]. From the mouth of the priest, the words of the Shayh are spoken with understanding via which they are written upon the members as one writes upon a tablet. In this manner the words of MaShayh, the drawing out of the Lamb, are spoken by Aharúwan unto the people. The Words of the Lamb pertain to the ascending Nature of Light—the Living Ones. The lives/אָװענע, rendered as “living ones”, denote the Names that comprise the Shayh/אָװ; hence, **the Lamb's Book of Life** is referred to as **the Names written within the Lamb, the body of YæHúwaH**, for it is the Names that are the source of all Lives, and according to the level of the Names' activities in Light, so is the body/house/dwelling states.

**In the Shayh/אָו is the Head of the Neúwn** as it rises upon the **Hhúwa** and the Base of the **Lammæd** upon which is the head of the **Shayin**. While the word, **Shayh/אָו**, is comprised of two Letters, there are Four heads present in the first squaring of Letters. Via the activity of the **Lammæd**, at the base of the Shayin, all 8 heads of Light are activated through the Shayh. (Regarding this process of activation, see the following section: *The Lammæd/Sceptre of the Yavúwsi*.) Thus in the hand of MaShayh, **the rod** is given that extends into the hand of Aharúwan—the enlightenment of all Names. What is in the Lamb is in the Mind of the Priest. Out of the Mind of the Priest, the words of the Lamb are spoken and written into the Book of Lives—the *Scroll of the Living Ones* in which every Name of Light is recorded.

The second squaring of the Letters within the Shayh is formed by reading the spaces in the midst of the four Heads. The Principle of “the second squaring,” is derived from the four corners of Wisdom. As Yahúdah-Aparryim extend to occupy the east-south and the west-north sides of the Mizbaach haOylah, the corners of RAúwaben-Dan arise to from the base of the Mizbaach haQetoret in the Mishkan. Amidst the Letters of the 4 Heads of the first squaring are the Semek and Tæyth and Hhúwa, indicating that within the Shayh of every Name is the means to *structure/⊕ all thoughts into pairs of the united faces/⊕ of Light/אָ*. As one extends the Hhúwa to the Neúwn and the Shayin to the Lammæd, the Letters of the ZayinOyin Body and the Head of the Yeúwd-ALphæh become apparent. Note, that via the Instruction/Lammæd arising out of the feet/foundation of the Shayh, all Heads of a Name become fully activated.

**The 8 Heads are activated via the SHAYH within a Name, for every Name is the Breath of the Fire—the Shayin Hhúwa/אָו—the Radiance and Crown of Life, and apart from this Nature, there are no living ones! The Presence of Breath is the evidence of the living ones in your midst. There is nothing coming forth out of the loins of ALOZAR that does not pertain to Glory, and nothing comes forth that cannot crown the Seed that is emitted. The crowning of every Seed is the ascension into the Yavúwsi State of the Lights. As the Seeds rise to the top, the seeds cluster within the mind and form a rock according to the foundational stones from which they arose. As a peach forms on the upper branches, so within the peach is the stone that arises from the base, and so does every Name form the upper stone according to the Principle sown from the mouth of the Priest within ALOZAR. This is the Rock that strikes the feet of the statue whereby Babylon tumbles like humpty dumpty that cannot be put back together again.**

**The Rock that forms at the Head is a united stone of two Names.** *The Names are interwound as strands/serpents of Light, and thus the concepts of their lights are fused/woven into a stone, as haTsur, from which they are emitted and sent forth. Even as the Shayin and the Oyin are in the midst of all things, so are the two Names in the midst of their Rock.* The United Names, both having the 4 square Principle, unite and thereby form the ARÚWAN—the ark of the covenant. In the ark are all the Words of Light and the Names of Light. As the Names are in covenant with one another, there is no violation one to the other which is the witness of their solidarity. **The solidarity is the fruit of Dan, being Shucham.** The joined squares are not static whereby they may form a circle or a square or become a cylinder or a rectangle. In the process of their arrangements, they create the House of YæHúwaH, as depicted in the medulla,

and all that is within the Haikal/Temple of YæHúwaH.

Within their branches are the productive thoughts of light, and upon their branches are the fruit of light, each fruit being according to a season/position of the Light. The seasons are of the four Principles of Wisdom in which is Understanding; within each season are three months. In the midst of each season is the month of Understanding giving evidence to Understanding being within Wisdom as the moon is within the sun. Each season forms a pyramid position of Lights, being a Teraysarun of the paired Names or joined sides of Light. According to the arrangement of their thoughts and the positioning of their members in unity with one another, the *moadim/seasons* are forever, and do not come and go as the summer and fall come and pass. As the fruit is formed upon their branches, their leaves and fruit do not fall off nor pass away, but abides to comprise the four faces of their united Names. Each of the four faces then is three parts, one part of Wisdom, Understanding, and Knowledge.

### The Lammæd/Sceptre of the Yavúwsi

The Head of the Shayh arises from the Lammæd, even as the Shayin forms upon the Head of the Neúwn and has at its base in the Lammæd. The Lammæd is at the head during all stages of planning and implementation even as the Rod of Aharúwan is present when every thought is composed. The position of the Lammæd/feet, being at the Rayish/head, is illustrated in the fetus as it rolls itself into an egg during the nesting phase in the waters of the womb. No one is sent into the world without their direction of the Light being planted within their feet. Even as every Name is a light and belongs to the constellations of the Light, so is the direction and the course of their movement within their feet.

As the details in the feet are released, the properties of mastery arise unto the loins where they are joined. At the loins, the concepts, as seeds float upwards into **the Oyin** consciousness, and the first head appears. As the Seeds are released from the Zayin, they take flight to the south and bring forth an extension of thought in **the Yeúwd**. The way that the Seed is able to take flight is via the Hhúwa, the Breath, that brings it to the crown of **the Shayin**. In this manner the Lammæd, or the scepter of the priesthood, governs all the lands, waters, and the firmament of the united consortium of Lights. As the Fire of the Shayin falls unto the residence via the nervous transmissions of Qahhath, the Lammæd then comes into the throat of **the Neúwn**, and via the Neúwn, the Lammæd comes to the throne of the heart. From the centre of the Kingdom, Principles are spiraled into ten rings, as a whirlwind, and come to rest upon the top of the mountain, at the head, where the Lammæd places its feet in rest. This is the rising of the sceptre into the Heads. This is the process of entering and living securely in the Yavúwsi Land.

Each Name has a Tablet upon which the records of their Name has been written; on the other side of the Tablet is the Name to which they are united. This is the two sided tablet of Light. Be aware of the carnal mind that seeks to rely upon what satisfies it and what will honor it, whereby it continues to repeat or play over and over what happened within the acts of darkness and therefore seeks to hold all of its members captive under Pharaoh.

### The Eight Circumcisions

The rite of the circumcision is the means of maintaining the preeminence of the Heads of Wisdom and Understanding above the forms and processes of thoughts. The manner in which one is circumcised determines their state of residence. According to the covenant/agreement of YæHúwaH with Abram, circumcision is the agreement for the procurement of the Lands, and without the agreement, the Lands become filled with other factions of thoughts. Clear your mind of whatever you considered circumcision to mean, for its concept reaches beyond removing the foreskin to every thought that proceeds from the heart and that which is spoken upon the tongue. Circumcision is not regulated to one Head alone, but to all Heads that rise upon the stalks of our Name as the husks of the corn are shed/cutoff upon the maturity of the ear of corn.

When the household of Names forsakes circumcision they become swallowed up in the states of Cham as YishARAL became housed within the veils of Metsryim/Egypt. Upon circumcision the families of YishARAL emerge from within the dwellings of Metsryim [Sepher Yetsiat Metsryim/Exodus 12:44-48; Yahushúo/Joshua 5:5]. Those who are of the native of the ARets/the Land are of the circumcision. To be of the circumcised is not a one time act, but rather an ongoing state of confronting the expressions and the level of residence in order that the Names of Light are governing the Lands [Yahushúo/Joshua 5:2].

Seven of the eight heads have become covered with the flesh of the harlot of Babylon [Chazon/Rev 17:9]. The Heads are called mountains for they rise from within the unity and bear blessings unto all within the valleys. The Heads are the evidence of the Illumination arising from within the unified members. Until the members are unified, the Heads do not emerge for there is not the inner strength to deliver them nor support them, even as a stalk cannot bear the weight of the heads of its fruit until its branches are unified and strong.

One Head cannot be covered for it does not subject itself to the language of Babel, that being the Head of the NEUWN Voice, through which all things come. Amongst the first to be uncovered or circumcised is the Zayin, depicted in the tongue and in penile gland. There is no difference in the two for the two heads are the two ends of one strand. With the Zayin Head one confronts elements of the Qayin/Cain property. If one speaks or if one sows to the flesh, then according to their projections of concepts and words they enter into the veils of flesh and become swallowed up as flesh weaves itself around the members. For as one speaks or as one sows, so is their state of residence. Therefore, as one speaks and sows unto Breath, they enter into the curtains of the Mishkan and weave around their members the coils of Light that do not wear out nor subject to decay.

How is it that circumcision become a covenant with Abram? Was it because the heart was faulty or that the emanation of Light was defective that it must be altered? In that Abram is the Friend of AL and upright in all ways to walk perfectly before YæHúwaH, how then is there the order to circumcise the offspring of that which cometh forth from the loins or from the mouth of Abram? The covenant of circumcision is given, *being an extension of thought* as Abram is sent into the ARets/the Land in which one encounters the thoughts of the Qayni. Those of Qayin/Cain are the thought patterns via which one acquires. Their thoughts are upon acquisitions and possessions instead of the thoughts of total giving which return to AL. As the Zayin becomes veiled at the base, so the Oyin of the head becomes clouded with thoughts of separation. For until one is of

total giving, there is a pulling away unto oneself as ChananYah (Ananias) and Shappiyrah held a portion for themselves apart from the collective [Sepher MaoShah Shlichim/Acts 5:1-11].

**It is imperative that we comprehend that circumcision is the covenant of the paired Names of the ALhhim whereby no thought of the Light is subject to be obscured or masked with the opacity of veiled cloth.** We are *to confront the base and the Head of every thought* and maintain our thoughts to be unified strands of two united heads, thereby eradicating all concepts of mortality from the Seed. Through circumcision the frequency of the seed is maintained to be of the Word consciousness. For if circumcision is not in the Mind of ALOZAR, then the ALphæh would not be sown in the Rayish nor would the Rayish return the ALphæh with blessings unto ALOZAR. For no ALphæh is given unless the Giver knows that the Seed to be given is cherished and tended by the receiver. If the giver does not sense the love and devotion within the receiver, then the giver does not impart what the Light has born within. For when one gives, in the purest sense, it is a giving unto the expansion of the Seed for the sake of the Collective of all Names. No Seed is imparted from the gates of the Lights until the soil is readied and a farmer is prepared to tend to what is given. Though one may ask for an answer, which is an opening of a concept, the request is served as one verifies inwardly that they are a candidate for the answer which carries the responsibility of fulfillment. As we proceed into the States of Light, **circumcision is the agreement whereby we maintain the Principle above form and whereby we define all processes to be means of expanding the nature of a Name.** In accordance with the brit of circumcision/ℓΥ™/mul, the Seed, being a composite of the Thoughts of ALOZAR, always returns from the base/AR with blessing to AL—the Mind of the United Order. [Sepher MaoShah Bereshith/Gen 9:26-27]. And with the returning of the ALphæh, the Lands become filled with the abundance of the Light.

Abram enters into ARets—the Land/ℓ44, *the Transformation Realm of Light* of ALOZAR, being a depository of Seed. *Specifically the Land is the State of Light/AUR/4Υ4 in which Seeds are deposited unto their full liberated expression/ℓ.* The Land incorporates all States in ALOZAR, from the base of the Qayni/Kenites unto the crown of the Yevusi/Jebusites. Beyond these ten states are outer and sub dimensions of thought. As one comes into the Land these dimensions are encountered. The outer dimensions pertain to thoughts of Qayin/Cain that suffocated Haval/Abel. For in that not all Seed have returned to the Mind, they wander and go beyond the realms of the Lands of Light as lost sheep stray from the folds of ALOZAR. In going beyond the agreement of AR and AL, the Seed are taken captive and subject to cruelty under the hand of carnality/Pharaoh [Sepher Yetsiat Metsryim/Exodus 1:22]. As one enters into the levels of Cham/thought formulations, they may go beyond the borders of Light, even as one goes beyond the House of Yúwsphah in Metsryim and falls prey to the thoughts *that do not know Yúwsphah, that is, that do not know how one is to govern the state or that which is one encounters.*

Though sheep wander, Consciousness from which they are sent is never severed from their Names. There is a strand of crystal fiber that is attached to every Name. Should the Laúwim and the Nevim not awaken and retrieve the lost, the very consciousness of ALOZAR is imparted like a pulsating vibration through the crystal strand to draw the lost back unto the Lands of



their dwelling in Light. With this strand attached to the Mind/AR of ALOZAR, Wisdom has secured every Name from destruction and enslavement. For the Seed, when it is first cast, remains attached to the source base as root strands. Though the branches fall, the roots remain secured by the stream of water that comes down from the Mountain in the AL of ALOZAR.

The murder of Haval/Abel causes the flow of blood to become subject within the house of Qayin/Cain. Being restricted by thoughts of possessions, **the blood, being the crystal flowing waterfalls of the Teraysarun/מא** cries, “**ALi**”/אלא, “**ALi**,” *that it may solely belong to AL* and therefore be set free from the bondage of selfishness and separation that enslaves the flow of thoughts for its own benefits. Into this pool the wayward thoughts become drowned and pollute the blood with their estranged thoughts. The flowing river/hadam of Haval cries “**ALi**” from the ground *until it is freed to flow with the freedom and pulsations of the Breath* [Sepher MaoShah Bereshith/Gen 4:10; Tehillah 22:1; Mattithyahu/Matt 27:46]. As the rivers arise through the necks they carry the crystal strand of consciousness from the loins to the Mind of ALOZAR. The blood rises to the top as the Mæyim, flowing from the Breath of the Neúwn. As the blood rises, the blessings of the twelve branches come with their fruit as offerings to the House of AL.

Because Haval/Abel—the ability to breathe freely becomes suffocated and not slain, the blood flows within *the ground/adamah, the composite thoughts of Adim*, instead of flowing upon the land from the neck. As the blood of grapes flows upon the vine, coming out from the necks/branches of the vine, so is the blood within us to be given upon the altar of ALOZAR. In that the blood is concealed within the thoughts and not given as the flowing of the thoughts, the blood is subject to mortality and the degeneration of flesh. As the blood flows within and not upon the necks, the Oyin Head becomes layered with flesh also. The base initiates the spirals out of the Zayin whereby the Oyin reaps the spirals of consciousness. The spirals of blood are to be as the rings of the gills on the fish, flowing at the neck. In the case of the Qayin/possessive/withholding mind, rings are cast down into a body and become intermixed with ground.

### The Seventy Spirals

There are 70 spirals of thought to full consciousness. These seventy comprise the Union of each pair of Names according to the spirals of Thought in the Faces of ALOZAR. Through seventy spirals, every pair of ALhchim are united into the consciousness of ALOZAR. Being 4 circles of thought in each of the three Houses of Wisdom, Understanding, and Knowledge, there are  $70 \times 4 = 280$  circles within each wave of Light. In joining the three levels, there are a total of 740 spirals that comprise the collective thoughts of ALhchim, which is interpreted as the transmission/waters/מא/40 of the 70/0 extended to the 10th power/אל. The 740 spirals are written as symbols: מאל, meaning the **glowing and might of the Rúæch** being referred to in the prophet [Yeshoyahu/Isaiah 11:15] as *the scorching wind* that smites HaNahar/The River Euphrates into seven streams/occupations—a complete flowing of Understanding out of the neck of the Neúwn unto a complete redemption, even unto the full occupation/inheritance of YishARAL.

There is no State of residence without consciousness, for even to abide in Metsryim/Egypt requires a collective of 70 to enter into the rings of definition. However, as one arises through the definition and beyond the enslavement to materialization, they graduate in consciousness by

extending the 70 Names into 70 spirals of perfect agreement with ALOZAR. Through giving/extending all within a Name, one has access into all 70 spirals of consciousness in which the fullness of the paired ALhhim reside. The 22 Letters are comprised as 12 pairs of thoughts, each thought being comprised of two Letters. According to the interaction of the pairs, the sounds of the word vibrate upon the lips. These pairs of thought are the basis for the Menurahh which contain 70 cups or 70 spirals comprised of the arrangement of the 22 Letters. The Letters, being pairs of the Taúwah X configuration, formulate the 70 cups of olive oil which are the spirals of full consciousness. The 70 spirals come forth from Yúwsphah and the Kings chamber in AR, as the rings of the tree come out of the base where the Seed of AL is cast in the oasis of Breath wherein it sprouts as a palm tree. As the rings expand from the base, the tree extends and brings forth the fruit of the almonds in the chamber of the priest in AL. When the spirals become condensed into a few rings, one does not comprehend the vastness of the dwelling spaces that pertain to their Name nor is their inner houses filled with the Lights of the 70. This is what it means that the carnal mind does not know Yúwsphah for it knows not the extent of all that in Yúwsphah and the rings that are brought out of Yúwsphah. As the spirals are folded and stacked upon each other, the inner house is dimmed and the spaces are small. The spaces between the rings have yet to open, being that the Breath is not designated to expand the Ring of Consciousness and to fill the Temple with the Light of the SHAYH. The Land of Metsryim are the outer dimensions of the spirals which provide distinction and color to every thought that comprises full consciousness. When the Pharaoh carnal mind of Metsryim does not know Yúwsphah, the outer dimensions yield weavings of mortality and the inner members become enslaved to the outer. As the outer rings arise out of the corona of Yúwsphah they attest to be in agreement with the rings in the priest mind whereby the former skins/garments of the wardrobe are shed, and the spiral coils of the Light become the defined curtains and robes of the Lamb's Temple.

The Mind of Qayin does not make the freewill offering upon the altar. Whenever there is not the freewill to give all within as the oylah/ascendant offering, the spirals of blood do not rise within the neck unto the head. With the thought of murder, Qayin brings an offering of the ground/*adamah* but not of the inward branches of life. In that Qayin does not give freely and totally, Haval is murdered; for the brother of breath—the one who upholds all thoughts and forms cannot be fully expressed; rather the form is offered by the Qayin and not the intelligence abiding within. Intelligence of Breath and its properties are held back by the acquisitions/materialization of the Qayin mind foreign to the House of YishARAL. In any state in which we desire to retain that which is inward, and give not all unto YæHúwaH, we proceed not into the paths of ascension.

The release of blood is the means of formulating understanding and joy through the expansion of Seed/concept. To mix the blood with thoughts of possessing is to build a house unto one's name, rather than unto the collective, whereby the blood flows within the thoughts and yet cries within the ground. Through **the crying of ALi** Yahushúo yielded up the Breath as an offering of Fire unto YæHúwaH and thereby releases the flowing of the blood with the Mæyim/water [Mattithyahu/Matt 27:50; Yahuchannan 19:34; Rom 8:19-21]. **The flowing of the blood/מִדְּאֵל with the Mæyim/waters is the flowing of all that within the Teraysarun/מִדְּאֵל with**

**Understanding/מִשְׁכָּל—the flowing of Breath!** As the cries ascend from the ground to ALi, the temple veils are rent and all of the inner rocks are split opened as when maShayh stuck the rock and the waters flowed freely from the inner core of the North. With the offering, the tombs in which all members reside are likewise opened until the inner residents emerge and reveal themselves to the multitudes of the collective [Mattithyahu/Matt 27:51-53]! The Mashiyach, the one anointed/flowing, is as the fish in which the blood is supplied in the gills —the fish’s **external respiratory** organs and is as the fruit of the trees in which the blood is in the exterior of the branches whereby it flows freely. We are not speaking of mortal blood as the offering but the very distillations of Breath that flow, thereby creating the Mæyim that is in all that is formed by Breath and not the flow of blood in the body of mortal flesh which belongs to the kingdom of Babel. The flowing of Breath is the release of the Seed Word that establishes a level of dwelling according to the level of consciousness in which it is released. In this manner, one transposes their essence and properties of Seed from the state of Metsryim unto the Lands of OyinZayin, belonging to AL, through elevating the bones/multiplying crystallizations of Breath/Semek/פֶּי in the House of Yúwsphah. This giving is the Yevusi State of freedom and mastery and in whose lands the offering is made and the holy city comes down. Accordingly, those of Daúwid, of the united Teraysarun/דָּוִד, obtain the Yevusi Land for the Haikal with the giving of the NEUWN. The Yevusi State is acquired by the gifts of the Kings of ARwanah and Daúwid whereby the NEUWN is exchanged freely in their midst, from ARwanah/אַרְוָנָה (The King of AR united to the NEUWN-HHÚWA Heads) to Daúwid and from Daúwid to ARwanah (being the 50/Neúwn shekels of silver) [Bayit ShmuAL/2nd Samuel 24:18-25]. The **free giving of the living issues/blood is the perpetual circumcision** appointed for Avrehhem and all Seed that comes forth from the Name. Upon this offering, the Haikal/Temple to YæHúwaH is laid and built. Establishing the House of YæHúwaH and offerings of its altar are final words of the scroll of Bayit ShmuAL.

### Accomplishing the Circumcisions with the Zayin and the Lammæd

The circumcision of the OYIN head is the Mind of Yaaqov overturning the birthright of Esau as the ZAYIN opens the throat of the goat and the learnings in the tent of the LAMMÆD prepare for the blessing. The circumcision of the LAMMÆD is the taking of the ZAYINserpent in the hands of Aharúwan which leads to the circumcision of the the Head of the SHAYIN to reveal maShayh. As one takes hold of ZAYINserpent, it becomes an unveiled LAMMÆD, and the Fire of SHAYIN comes out of the mouth. Thus as one Head is circumcised, the others are quickly unveiled in sequence.

The process of turning water—Mæyim to blood/מַד is how the Hand of Aharúwan uses the unveiled head of the LAMMÆD/staff/instruction to teach the people unto the path of freedom. The circumcised LAMMÆD leads the minds of all YishARAL to comprehend that through the instructions/LAMMÆD of Understanding, one turns the waters/Mæyim into twelve houses filled with blood for the offerings to be presented in the Stages of haDevar (Bemidbar). The Mæyim turns into blood as the Head of the LAMMÆD determines, reveals, and points out to all minds that what is within the waters is to be free flowing for the altar. Turning water to blood signifies that the blood is running again for the altar of YæHúwaH from the suffocation

of Haval by Qayin/Cain [Sepher Yetsiat Metsryim/Exodus 7:19,24; 8:26;10:24-25]. The evidence of the LAMMÆD head being circumcised is when one commences to follow the instruction of the unveiled meanings in the Túwrahh.

The Hhúwa is unveiled as it rises through the House of Babel which covers over the meanings and the articulation of the Breath, hiding the Light within foreign languages. The NEÚWN is always guarding the passageway of Breath and the means to formulate Words, keeping watch daily until the Hhúwa is liberated whereby the cry of ALI may again rise into the consciousness of all Names. Due to the positioning of the NEÚWN, the pearl of great price is reserved for those who seek beyond the veils through the circumcisions.

The YEÚWD is circumcised as it is in the hand of the priest Qúphah whereby the deeds are distinguished according to the Wisdom, Understanding, and the Knowledge according to the parts of the YEÚWD (arm/hand). As one overthrows the works of flesh, the Hand is liberated to perform the deeds of righteousness. The YEÚWD is empowered by the ALPHÆH as it spins in the Mind a garment of Light and arises from the base into the Rayish. As the ALPHÆH is no longer designated for mortality, it overthrows the garments of flesh and receives the robes of Light. The unveiling of the ALPHÆH is opening the sac of BeNiymaN in which is the ALPHÆH grain and receiving at their lips the cup of salvation, the silver cup, that leads to the garments of immortality portrayed as the five raiment from Yúwsphah (Joseph). Circumcision occurs as one attains to the River of the Yordan—acquiring the Knowledge of Dan, in Gilgal, whereby one may partake of the unleavened cakes of parched grain, the Seed being no longer subject to the leavening of mortality [Yahushúo/Joshua 5:8-11].

In these manners, the Heads of the South, being the OYIN-ZAYIN, and YEÚWD-ALPHÆH are the glory of the Heads of the North: the LAMMÆD-SHAYIN, and the NEÚWN-HHÚWA, from which they come forth to declare that the Living AL is ONE, enduring forever, and that the Unified Kingdom can never be destroyed, being a Dominion forever [DaniAL 6:25-26]. The united Heads form the Consortium of the Lights, being now the Masters of all that they have risen through. In their UNITY, they form the crown of the everlasting Kingdom which has no end. Accordingly, 4 Heads appear at the corners of the cube.

### The Interweaving of the Letters within the Heads

According to the alignment of the Eight Heads arising from HaTsur/The Rock, so are the pairs of the 22 Letters arranged and called/read. **The paired Letters of ALhhim are the thoughts from within the Heads**, that comprise their celestial bodies and their crystal clear streams/states of inheritance, even as the parts of the body are according to the head. From the sides of the North within the Mind, there issues forth the assembled rivers—the flowing of thoughts. As the Heads emerge and are unveiled to operate without the dictates of the flesh, so every thought comprised by the pairs of ALhhim may be fully expressed, being unhindered by any degree of self exaltation that comes from any degree of separateness. All thoughts emerge through the Unity of the 8 whereby the Heads now convey the fullness of ALhhim. Those who join their four strands into one cube may operate in the full Nature of the Light and all thoughts that are flowing from the Rock.

According to the thoughts of the Heads so are the levels of the Letters being expressed and entered into. If the thoughts are complete, then we are in full accord and in agreement with the Letters—being pairs of ALhhim in which is their strength. Thus the term AL or ALhhim is rendered as strength. The strength comes by the union to which they belong. However, if the thoughts are incomplete, being of self distinction/importance, they then pertain to degrees of separateness—which determines how far one is outside the 70 spirals of AR-AL. In degrees of separateness, the flow of the Nature of the paired ALhhim are cut short within the mind and one does not know to whom they belong or where one is going/proceeding. In that there are 70 spirals within the pairs of ALhhim, then there are 70 spirals/degrees outside the pairs. Those that abide in sheol/hell/לְעֵלְוֹת are those who dwell without the Shayin-Lammæd Heads activated, and thus they cannot comprehend the instructions that proceed from the Fire even though they dwell in the midst of the Fires and the Teachings by reflections. As we have come to know the location of the Ten Lands and where the priests and kings abide, so likewise we know now the location of hell, being of the sixtieth unto the seventieth degree of reflection from ARAL. To be more fully explained as we discuss the Names of the Lammæd and the Shayin following in this document, the term, sheol/לְעֵלְוֹת, is composed of the parameter Letters of the 70 spirals thereby signifying the degree of reflection that forms this state of consciousness absence. In that the Lammæd is the value of the 60th degree and the Shayin of the 70th degree the realm of sheol/hell, is in the band of the 60th-70th° of reflection. All reflective/mirrored states are those outside the 70 degrees of ARAL, for in ARAL there is the *halavanahzakar*/אֵי אֵלֶּיךָ אֵלֶּיךָ—the pure clarity of thought depicted in the spices that arise upon the Altar of Incense/The Altar of Wisdom—*haMizbaach haQetoret*. Yet even if some are afar off to the seventieth degree beyond the outside spiral of AR-AL, yet the Mind of ALOZAR may reach them. The closer one comes to the 70 spirals of AR-AL the clearer is the Voice of the Shepherd. As one enters into the 70 spirals of ARAL there are not distractions or desire for that which is outward. Herein is the inner evidence that one has left their former habitation to dwell in the Lands of IO/OyinZayin. The Letters comprising the spirals of AR-AL/לְעֵלְוֹת/comprise the word commonly translated as a lion, to be valiant, a transmutation of thought unto a higher level. As the ALphæh is sent from AL it arises from AR and expands into the mind of the priest to reveal its glories. The combined Names are as ones sent—angels/messengers of Light/AUR, depicting those who can overcome all states and abide within the House of the Unified Names [Yeshoyahu/Is 33:7]. *Lit.* those of ARAL *see the ALphæhLammæd/לְעֵלְוֹת base of all thought, being 13/4, as in 4 squared, and dwell not apart from the Union of Names. These/לְעֵלְוֹת are those who are spoken of as worthy, as those counted/numbered to abide in the midst of the paired Letters. These are called the inhabitants of ARiAL—the lions with the Shayin Mind. The Name ARAL has been of mystery and obscurity to translators, having been hid from the minds dwelling in the degrees outside the 70 spirals. Those of ARAL speak the seventh level of Gad, being mouth to mouth as is AL is to AR.*

In ARAL we are of the paired Letters of ALhhim and that the gifting of the Letters are the very Nature of our Names of Breath. Each Name is a strand woven into the composite thoughts of the paired ALhhim. No one possesses all Letters unto themselves individually, for such would violate the Order of the Union, nor does one Letter abide apart from another. The Letters are known fully by pairs of Names only, lest they become restricted to one Name alone and thereby their creative and full expression of the glory is cut short. The pairs of Letters comprise the warp and woof of each united set of Names. For not even ALOZAR would restrain one

Letter to be a possession apart from the whole. Rather all Letters are given to comprise the full consciousness of the waters of Breath, being the sum of 740 spirals out of which flows/מ the complete revelation/ו of ALOZAR. Within the United State of ARAL the pairs of ALhhim are at liberty to interact and to be freely woven with the side of any Letter, whereby words are formed, to carry forward the messages and glories of Light. The forming of words and their flow of messages comprise the seven streams of revelation in the prophecy of Yeshoyahu/Is. chapters 10-12. Through this **liberty of perfect Unions the messages of Light are compounded** and multiplied.

In that our Letters are not a possession of ALOZAR, then what does it mean that the ONE of YæHúwaH is jealous for his own possession? It may be stated with understanding that we are an inheritance of ALOZAR—ONE of YæHúwaH, in that we are embody the Mind of ALOZAR. Through our Union of Names, thoughts of ALOZAR expand and fill the spaces of 70 spirals known as universes of LIGHT. ALOZAR gives with freedom, being a possessor of no Name. Rather there is the expectation and the joy in ALOZAR to behold the wonder that is compounded in the thoughts of those who are United with the Unified Names of ARAL.

The Names of the Letters of ALhhim מןלעכ

Through the positioning of the Letters amongst each other, according to the thoughts of ALOZAR, there is perfect freedom to be joined by together by Names. Though the Union of the Names, the full revelation of the Letters and their Names are set forth.

The Letter NEUWN, being the source through which all thoughts come to flow and that which is in the midst of the Letters, is comprised of the waves of thought that are emitted from the Center of Consciousness. As the ONE of PERFECT UNITY draws out an unfoldment of thought in the midst of ARAL, the NEUWN appears. Through the interchange of ALPHÆH from AL to AR and from AR to AL, both sides of the NEUWN appear whereby the Name of the ALhhim is called NEUWN/נננ.

As both sides of the NEUWN are joined, The Letter NEUWN establishes a wave of LIGHT, commencing with a NAH/נ sound and ending with a NAH/נ sound as sides are joined by WAW/ו to one another to convey thoughts in the NEUWN/נננ. According to the double NEUWN, there are the two sides of the neck from which the full revelation of the 12 flow.

Names in the midst of ARAL are called and read according to the frequency within the pairs of the ALhhim. In that there are twelve pairs and twelve houses of YishARAL, each house of YishARAL belongs to a pair of ALhhim, for the 12 pairs of thought are the 24 ALders (Elders) from which each of the Houses are established. The House belonging to the paired Letters of the NEUWN and CHAYIT is the House of BeNiyman, BeNiyman/נניננ (Benjamin) which arises/Chayit within the necks of the Neúwn. The House of BeNiyman abides within the pairs of Names according to the wave and frequencies emitted by the NEUWN. *Lit.* BeNiyman: BeNiyman/נניננ is the House/נ of the NEUWN/נ in which the Neúwn is extended to the 10th power/נ through the distillations/vapors of thought/מ that are within the NEUWN/נ. According to the provision of the NEUWN-CHAYIT, the Seed of every

Name does not suffer decay; nor is it bound to any level of thought, but is fully empowered to ascend unto its full stature.

The NEUWN wave carries the Seed in the midst of ARAL from one end unto the other even as the necks extend from one end to another. From the waves of NEUWN-CHAYIT there appears all of the pairs of LETTERS. It is not because the NEUWN is the first Letter, but that it is the primary wave to carry the ALPHÆH of AL to AR whereby there is LIGHT/AUR [Sepher Maosah Bereshith/Gen 1:3-5]. This carrier of the Seed of ALphæh to AR is the serpent of antiquity through which all thoughts arise from AR to be carried upon the tongue. The NEUWN, being of the paired ALhhim, doubles/multiplies itself as two ends of the Unified NAMES fold upon each other whereby the NEUWN bears what is within and thereby formulates a house a joined Letters—NEUWN-ÚWAW-NEUWN. The House of the NEUWN is comprised of the waves of the inner most thoughts through which the messages of the Seed are transmitted.

The NEUWN being in the midst of the ALhhim is why *the noon of the day* is in the midst of a day and why the NEUWN is positioned in the midst of the anatomy *at the apex* of the body. The neck in the midst of the body is at the zenith of the body and is **the means of extending that which is in the heart**. Yet are there not other elevations beyond the high point of a day and beyond the ascent within the neck? The neck is the object that is embraced and fallen upon as one comes to enter into the full revelation of what is in the midst of the fire. Through the Letter NEUWN, AL draws out all in the midst of the Fire from the altar of the heart and bears all thoughts that pertain to the Mind of being squared/four sided. Belonging to the Nature of ARAL, which gives freely from one side unto the other, so the NEUWN likewise draws out all within itself **the vapors of Breath** whereby there appears the MÆYIM. The MÆYIM are then called **the waters of the NEUWN** into which we enter to be immersed into ONE BODY—the BODY of ALOZAR.

In accordance with the wave of the MÆYIM the Seed expands in the waters and forms a body. All are birthed of these waters, those above and those beneath as well as those born outside of **the covenant bonds of AR and AL**. Those that dwell in reflective realms enter into the waters of the Metsryim/the womb of mortality to be born into a world that does not know ALOZAR nor Yúwspah, yet it is through Yúwspah that all are born and brought forth with full extension. Thus **the House of Yúwspah**/אֱלֹהֵינוּ אֱלֹהֵי אֲבוֹתֵינוּ belongs to the pairs of the ALhhim of the MÆYIM-TÆYTH for in these thoughts of ALhhim, are the means to transmit/אֱלֹהֵינוּ the vapors/אֱלֹהֵינוּ of the NEUWN and to structure the fruit/אֱלֹהֵינוּ that is born at the level of the transmissions. The Name of Aphraim *Lit.* means, the ALphæh/אֱלֹהֵינוּ have been transmitted and extended/אֱלֹהֵינוּ results in fruit/אֱלֹהֵינוּ.

As one crosses the realm of the reflective into the real, they are immersed in the MÆYIM of the NEUWN to become as Yahushúo Ben NEUWN, as those born of NEUWN, whereby they also bear within themselves the full revelation of ALOZAR. The NEUWN, bearing the value of 14, expresses that it is a double 7 whereby from its midst one may come to both ends of the Light and know all that is of the Light. Without the NEUWN opening one cannot know the full extent of ALOZAR. The gate of the NEUWN is the circumcision of the House of ALOZAR, and thus, the NEUWN's Gate is never closed nor veiled nor should any object as a necklace of jewelry be placed over the neck—the Gate of LIVES. Within the NEUWN is the

greatest pearl of all, and nothing of this world can compare to the radiance of this pearl of great price. Anything placed in the midst of the neck interferes with the wave of the NEUWN being of a lower vibration that cannot be synced with the messages coming out of the prized pearl.

The value of 50, being an extended value configuration of the NEUWN, conveys the liberty of the MIND of ALOZAR to explore the vastness of perfect thoughts within all spaces and to attain the fullness of the LIGHT. As the NEUWN folds upon itself it thereby positions itself to give to reveal all within. The flowing of the NEUWN becomes known as the vapors of Breath, which are gathered as the MÆYIM to be the rivers and seas, and in their midst there is the forming of the Lands of the OYIN-ZAYIN. In that the NEUWN is of perfect Unity, the sides thereof are of the ONENESS of ARAL. The NEUWN is called and read from the mouth of ALOZAR to be ם׃׃.

In that the NEUWN is foremost in appearance of that which is in the midst of ALOZAR, the NEUWN is in the position of the first evening of thought whereby there is LIGHT/4׃4 — the wave of Thought occurring as the result of the ALPHÆH being passed unto the Mind—from AL to AR. As the ALphæh is transmitted from AL to AR, a wave of Wisdom and a pattern of transmission is established from one end unto the other. According to this pattern there is the Presence of the LIGHT from one end of the horizon to the other each evening and day. As the Seed expands in the MÆYIM and opens in the MIND of the RAYISH, there is an expanse of the SEED whereby there is a firmament for all NAMES to expand within, the firmament being a wave of Understanding. The firmament expands as SEED is transmitted whereby space is allocated for the glory of the thought that is laid within the lands [Sepher Maoshah Bereshith/Gen 1:6-8]. The firmament/expanse of space stretches from neck to neck, being the OYIN-ZAYIN/IO in the midst of ARAL/׃444.

The MÆYIM coming forth at the side of the NEUWN is the nature of thought to gather what is transmitted and to further transmit the messages, by flowing, unto its full revelation. Being of the nature of the NEUWN to give totally of itself without reservation of separateness, the MÆYIM gives all within the waters, holding back nothing for itself, for when the waters run they do not stop until they have poured out everything in the cloud and then it vanishes. This full giving is conveyed by the YEÚWD which abides in the mist of thoughts being transmitted even as the House of AHARON abides in the cloud and in the midst of the great darkness as the words of the ALhhim are composed upon the stones [Sepher Yetsiat Metsryim/Ex 19:24]. ***For unless Aharúwan is present, maShayh (Moses) cannot go up into the mountain again which is the next level of enlightenment.*** When the stones are inscribed, the Enlightenment is present whereby all of the stones are arranged within a dwelling by the mouth of Aharúwan, and thus every house follows the pattern and the arrangement of the stones for all are of the pattern in the Mount—in the Enlightenment. In that Aharúwan dwells in the midst of the MÆYIM, they have mastery of the waters with the LAMMÆD. Thus within the LAMMÆD-YEÚWD pair of ALhhim is the House of Laúwi which abide in the midst of the camps and at the side of the House of Yúwsphah on one side and abiding around the Tree of Lives in their midst. *Lit.* the Name of Laúwi/׃׃׃ is the Union of the Lammæd and the Yeúwd. The Union of Yúwsphah and Laúwi, depicted in Yahushúo Ben Neúwn and ALOZAR, is paramount to bring all Names across the MÆYIM into the Lands of HaDevar and unto all States of Light.



The MÆYIM is called and read from the mouth of ALOZAR to be מַיִם. The MÆYIM appears as the waters above and below the firmament which are the two ends of ARAL [Sepher Maoshah Bereshith/Gen 1:6-8]. The first MÆYIM in the Name of the Letter is the upper waters, being nearest to AL, and the second MÆYIM is the lower waters, being nearest to AR. For as Breath is extended from one end to the other, so the waters gather at the necks from which they flow. The waters above extend to the base which carries the ALPHÆH Seed from the crown to the foundation and then expands the Seed from the base that it rises to the crown. As the Seed rises, it passes through the waters of the foundation to fill the House built by the Unified Names. In this manner the Principles of Light run from the priest's quarters to the chambers of the kings daily and from the king's garden to the priestly mind. As the neck is opened each evening and morning for the oylah offering, the ashes are flow upwards to the neck where they are deposited in the east. As the neck is opened at the time of the offering, the waters begin to flow through the ashes. As the waters flow through the ashes there flows a pure crystal steam of thoughts running from the throne of AL with the Shayin-Ha/the SHAYH [Chazon/Rev 22:1]. The opening of the neck of the sacrifice initiates the flow of thoughts for each night and day. For in that the ashes are the retention of total giving and perfect unity, what flows through them is a pure stream of liberty that fills the basin of the laver daily, thereby known as the waters of regeneration, and then rises with the smoke from the unified sides of the offering.

In that the MÆYIM is counted as 13, and being double as the NEUWN, the multiple Letters of MÆYIM are the value of 26 whereby all that is within the waters bears only the image and the likeness of YæHúwaH. Every Name is called and read according to the pairs of ALhhim to which it belongs. This is the calling/reading of the patriarch, as the mouth of ALOZAR speaks through Aharúwan, the unified offspring of ALOZAR.

With the MÆYIM is interwoven with activities of the NEUWN to comprise the acts of the evenings and the days two and three in which the firmament runs from the crown to the base as a river flows from the mountain unto the great basin/sea/laver below [Sepher Maoshah Bereshith/Gen 1:6-8]. The value of 40, being the tenth power of 4, as 13 reduces to 4, conveys the value of thought through which one is brought forth from the loins of AR or from the mouth of AL. The Name of 40 is Aharúwan, the means in which all are born and brought forth in ALOZAR. There are those who are born of the BREATH and those that are born of the flesh; there are those who are born by the will of ALOZAR or those born by the will of flesh. For as one is born of BREATH they are born for the Kingdom of BREATH according to their will of perfect unity and submission into ONE BODY. They that are born of flesh are those born/emerging for the flesh according to their will of separateness and distinction from the ONE BODY of LIGHT.

The LAMMÆD comes through the MÆYIM as the serpent comes out of the waters and hangs upon the Trees within the Lands. The Lammæd distinguishes the waters as to the direction of their flow as well as all that are within them. By **the wave of the Lammæd**, which is **the movement of the serpent**, the ALphæh travels from AL to AR whereby the ALphæh is given to arise in the spirals of the oaks/Quphah, which are known as the Oaks of Mamre, the dwelling of Avrehhem [Sepher Maoshah Bereshith/Gen 13:14-18].

The LAMMÆD, being the rule of the Lights, orders and classifies all thoughts according to their wave of Lights. As a **space capable of being cultivated** (known as good soil) appears in the midst of the MÆYIM so space is read for cultivating the Seeds of Light unto their full extension—to be the ARets—in which the Seed is transformed unto a Tree of Lives. As the Seed is watered and now warmed by the AUR/Light, what is within the Land commences to shoot upwards to multiply and bear the Seed that is sown in good soil and watered from the MÆYIM [Sepher Maoshah Bereshith/Gen 1:9]. As the space capable of being cultivated is seen with us by the Eyes of the ALhhim, the properties of our Seed are released unto our Enlightenment/Kohen [Sepher Maoshah Bereshith/Gen 1:9-12]. The giving of the Seed is by the instruction of the Kohen with the LAMMÆD. The evening/consideration and the morning/observation of the Seed being released is the third act of the One of ALhhim. The same is the Seed arising from AR to AL. The Seed comes from the AUR, the space being designated by the LIGHT. Within the House of The LAMMÆD are the evenings and the days of three and four in which the considerations and deeds of the One of ALhhim are woven together. **For with every breakthrough and emergence of Seed, as on day three, so authority is given to govern over all as the lights rule night and day**, as on day four [Sepher Maoshah Bereshith/Gen 1:9-19]. In accordance with the arising of the Seed so is the degree of authority and mastery. The Order of the Lights are called to be the sun, the moon, and the stars. These Lights are the Lammæd or the Rod of Authority over the Land which are in the YEÚWD/hand. With the rod one governs over all spaces for the glory of the the Tree of Lives.

The LAMMÆD is paired with the YEÚWD. In these pairs of ALhhim all of the offspring of Laúwi dwell. When the One of YæHúwaH ask maShayh, “What is in your hand/YEÚWD?,” the answer is the LAMMÆD, the staff. Both Letters, the LAMMÆD and the YEÚWD, are of One House of ALhhim and what is one is in the other. When one does the Túwrah by their hands, they have the movement within their feet. The saying that “the feet are in the hands” means that *progressions are in the performance* of every word of Túwrah. If one is shown to do anything according to Light and stumbles therein, the feet become lame and one cannot walk in the Light. One is *lame* when the Dallath of the *Lammæd* is missing which conveys that one is going apart from the Teraysarun Dallath of united Names. What we do is seen by those in Light, and accordingly, as we are seen it is determined if the spaces within us are capable of being cultivated by the Lights. To these spaces the LAMMÆD comes, and with the LAMMÆD the Seed of ALhhim is given.

As full properties of the Seed open under the direction of the LAMMÆD, the KEPHÚW or Tree of Lives stands in their midst. The doubling of the KEPHÚW is the full Sayings/Paúwah of the LAMMÆD, being spoken by the Heads of the both the LAMMÆD and the YEÚWD which branches forth from its sides/Υ. The KEPHÚW/ΥΥ is called and read to be the Sayings of the LAMMÆD from which the Mouths of the Tree are filled with the Teachings of the Kuwhænim/Priests. As the Mouths of the Tree open, one has access into all realms of the Names and their lands.

In the pairs of the ALhhim of the Kephúw dwell the House of Gad. For the Tree of Lives is comprised with the Sayings of Light, each side being of the teachings of Wisdom and Understanding, which are grouped into Sayings that comprise Totality  $\Upsilon + \Upsilon = \text{Taúwah}/X$ . The

two sides of the Tree of Lives are comprised of all of **the Teachings of the LAMMÆD, and thus all of YishARAL, as they come to know the full teachings of Light, come to dwell forever in the House of the Laúwi, the ONE BODY of the Mishkan, which is of the LAMMÆD and the YEÚWD, the centre in which the Teachings of Life are engaged/performed.** Apart from the Teachings of the Laúwim there is no Tree of Lives and without the Pairs of ALhhim there are no teachings of Light. In that the Words of Light never perish, neither does the Dwelling comprised of the Words of Light [Tehillah/Ps 23:4-6].

The LAMMÆD is evident as the Orders within the MÆYIM are classified. Hence, from all classifications of thought come the teachings or the Trees in the midst of the garden. Coming through the MÆYIM, the LAMMÆD/Δ<sup>∞</sup>∫ is called and read to be *the Instruction of all classifications/paired thoughts/∫ in the MÆYIM/∞ of the unified house/dwelling/Δ*; for every Teaching, if it is of ALOZAR, comes through the waters/distillations of the NEUWN. When all of the waters—the MÆYIM flowed it became evident that there are three categories of thought: the Principal/∫ of Wisdom, being the Foundation; the Consciousness/O of Understanding, being the Extender and Stabilizer which encircles the Principal; and the Abundance of Knowledge/∇, the Fruit. These three, being of ONE baptism, as they come through the MÆYIM together, stood next to each other, as aligned sides, to become the DALLATH or a Teraysarun of 12 sides—the foundation of all Teachings of LAMMÆD that arises through distillations of Breath.

From the meditations of the LAMMÆD as one contemplates the Teachings of the Túwrahh, comes every multiplications from the distillations of Breath (the swarms in the waters) to become a living soul/*nephesh chayah*, with the freedom to soar/fly in accordance with the Light of every opened Seed and in accordance with the Sayings that fill the expanding firmament of ARAL [Sepher Maoshah Bereshith/Gen 1:19-20]. The acts of the LAMMÆD, are they not in the evenings and the days of four and five? As the LAMMÆD plants and cultivates all thoughts within your spaces, you become a living soul filled with the abundance of LAMMÆD/teachings according to the expanse established in your midst. As one gives from the NEUWN the expanse or the firmament is provided for the flourishing of every Principle Seed of ALOZAR. We receive the LAMMÆD according to all that is given by the NEUWN and in accordance with all that is gathered and transmitted through the MÆYIM.

The value of the LAMMÆD is 12, which reduced to a 3, denoting the instruction of the LIGHT to be of Wisdom, Understanding and Knowledge. In these three Houses, the rods of Light abide. The **1** in the **12** pertains to Chækúwmah/Wisdom, the Principles; and the **2** in the **12** pertains to Bayinah/Understanding, the Extender. In accordance with Chækúwmah and Bayinah one rules night and day. The extended value of 12/3 to the tenth power, is 30. Accordingly there are 30 days in a month in which the Queens govern by the LAMMÆD night and day. During the course of a year, Chækúwmah dwells within each camp/tribe 30 days and Bayinah is within each camp/tribe 30 days and 30 nights in that Bayinah is always within Chækúwmah as the moon is within the sun and extends beyond the Light of the sun. In that Chækúwmah is One/1 and Bayinah is Two/2, there are 30 days in which Chækúwmah comes into the camps and 60 evenings and days that Bayinah comes into the camps; together there are 30 days of Chækúwmah and 60 visitations of Bayinah = 90:  $1(30) + 2(30) = \text{Tsædda}/90$ , conveying that the presence of the LIGHTS leads unto the full extension/measurement in liberty.



The Four Pairs in the Centre are joined as paired thoughts each comprising the configuration of the Taúwah: XXXX. **Within the House of B’NiymaN is the House of Yúwspah/⊕⌒, and within the House of the Laúwim is the House of Gad; for the House of grace/⌒⌒/B’NiymaN is full of fruitfulness/Yúwspah, and the House of Unified Instruction/⌒⌒/Laúwi is full of words/Gad. By grace the full measurement of each Name arises out of B’NiymaN, and in its midst is the unfolding of the Túwrahh through Laúwi—the Tree of Lives/Υ [Yahuchanan/Jn 1:16-17].** This is the beginning of declaring the full counsel if the ALhhim.



As we examine any teaching, we determine the branching of its thoughts and the fruit that is born upon its branches. Are the branches paired? Is the fruit according to the thoughts of the NEUWN—CHAYIT/Chan/grace? If so, this is a teaching of the thoughts in ALOZAR, which are whole and complete and endures forever. From all of the sayings of paired thoughts comes the study of cabala which is the study of paired/associated teachings. Moreover, do the teachings correspond to the three categories of the Lights from whence comes the sun, the moon, and the stars? For when the examination or inquiry proceeds into the 4th day, the Lights become evident which were and are and always will be, yet through the 4th day—the act of inquiry—we behold them. Hence we say that the Lights came to us by inquiry, even though they were already in the Mind of ALOZAR yet to be revealed by our inquisitions into all teachings—the LAMMÆD of Aharúwan.

Which leads us to ask, how is it that the One of YæHúwaH is ALOZAR, when all comes from the NEUWN? By saying that all comes from the NEUWN means that all comes by the opening of the well of eternal consciousness through which the Name of ALOZAR/⌒⌒⌒⌒ becomes evident, being an appearance or an Apparition of Thought, as a frequency waves or vibrates together from its ends to produce all sounds of music, Letters, and their combinations of words. As complete thoughts are drawn out of the well, the words within the frequency are arranged upon a scale to be sung unto the Name of ALOZAR, the Source of all unified thoughts. Through the vibration and not the word itself apart from the vibration, do the messages of ALOZAR assemble as notes assemble upon a score to be read. Having permitted access into the strings of the Unified Mind, the path into the courts of ALOZAR are opened, and the songs are then heard in the courts of ALOZAR—only those which have come forth from the well and carry the vibrations of thought. This is also known as the dancing Letters within the Fire. The assembly of thoughts is the world/Tubal of Light in which all is transparent and in which there is no darkness. This state of illumination is the Shayh/Lamb/⌒⌒ of ALOZAR for the assembly of the Thoughts is the glory of the Light. The worlds are revealing every spectrum and sound of Light which are the results of the opening of the ALPHÆH that is

sent forth from the LAMMÆD of ALOZAR. Which leads us now to behold the Letter Hhúwa that appears with each opening of the ALPHÆH through the portal of the NEUWN.

X  
 W 4 ϕ ρ ρ O ϕ  
 γ ρ ρ ρ ρ ρ ρ  
 I ρ ρ Δ ρ ρ ρ

The Hhúwa is now the 11th Letter to become an apparition of the Light, following after the Neúwn, ÚWah, Mæyim, Yeúwd, Lammæd, Dallath, ALphæh, Oyin, Kephúw, Paúwah. As the Hhúwa appears it takes its seat in the Tubal of ALOZAR as one takes their seat in the great council of the 70 from which come the 22 Pairs of Thoughts. For having 11/Kephúw now appearing, we also have the 11 to which they belong. For as we are given a glimpse of one side, all 22 can be seen and their voices heard. This is the manner in which all Names assemble their thoughts as they arise, breaking forth from the ROCK upon their well of collective consciousness. Having now 11 Letters, we are set to read the 11 that are upon the other side, through which we proceed upon the path of the 11 days into the Lands of the OYIN-ZAYIN [Mishneh Túwrahh/Deut 1:2].

In that we have laid a foundation of paired thoughts, we proceed to the left of the DALLATH to the Hhúwa and enter into the House of the ALhhim of the Hhúwa-Gammal which serve to give Light in all proceedings. The HA, being at the base of the LAMMÆD, is called “*the lamp unto my feet,*” and being joined with the GAMMAL, the Hhúwa is called “*a light to my path*” [Tehillah/Ps 119:105]. In the Hhúwa we are able to journey into the paths of the Lands and travel into the Gate of the NEUWN to behold all that is within the every flowing River of Life. The HA/𐤇𐤁 is so called and read as the ALhhim which open the ALPHÆH, and with each opening there is a Radiance of Light flowing—HA. As the HA flows, the GAMMAL fills and widens with the HA, flowing like a river to water all of the Lands within its midst. Through the neck/GAMMAL/𐤇𐤁𐤆, the transmissions/MÆYIM of the LAMMÆD flow to fill the entire dwelling with Light. The activity of the Letters Hhúwa-Gammal are the commencing of the offering of the SHAYH through which the Temple of ALOZAR is a Lamp and filled with Light. Within the pairs of the ALhhim of the Hhúwa-Gammal abides the house of Zebúwlan, for it is in the Hhúwa-Gammal that the double DALLATH—HaTeraysarun—arises, coming from the River of the Hhúwa through the neck of the GAMMAL. Remember that the DALLATH is the sum/4 of the three houses of the LAMMÆD/29/11 from which the double Kephúw arises, as the LAMMÆD/12 is extended by the YEÚWD/10 to comprise 22/4/DALLATH.

The House of Zebúwlan, the resident in the Hhúwa-Gammal, is the base of the house of B’Niyman, the resident house in the NEUWN-CHAYIT. The Lands provide the foundation for the Seed to be sown and to arise fully within. The Seed is sown as the mouth of the NEUWN opens through Balao (Belo) of B’Niyman, being accepted by the Breath with the purpose of becoming fully extended to the CHAYIT. The Seed is provided the dwelling state of the Lands of Zebúwlan, as the base of the Hhúwa to ascend through the GAMMAL.

The Hhúwa designates all within the Lands and begins to fill the Lands with the bounty of the Light. In this manner, there are two parts of the moon as two halves of the buttocks/basin/oasis in which the Tree of Lives is sown and out of which it arises. The giving of ALPHÆH is with the Letters of the first half and then the SEED rises with the letters of the second half. One half receives of the ALPHÆH and the other half gives all within the ALPHÆH to proliferate the state of fullness. According to these two parts, there are two bullock for every Rash Chadash offering which initiates the complete work of the Union of the Lights. Within the Hhúwa are ten parts, conveying that the full extension of the Light is within every opening of ALPHÆH which is then filled through the flowing of the Hhúwa into the GAMMAL, being of six parts. Together the parts comprise the OYIN Mind/16 parts, the full consciousness/O.

Having arranged the pattern of the 11/Tree of Lives in our midst, the GAMMAL, being the 12th Letter of apparition, opens the gate for all Names to proceed into every state, whether it is the movement from AR to AL or the coming B'Churab/𐤁𐤀𐤅𐤁, a way of the illumination of Shoyir/𐤀𐤋𐤛, unto Qudash-Barnao/𐤒𐤕𐤔𐤗𐤁𐤏 (Kadesh Barnea). There are 11 acts/days of the ALhhim/Principles of Light in which we proceed from associated/paired thoughts B'Churab (in Horeb). From Churab/pairing we proceed into the Derek/Path of the illumination. The Derek Shoyir, being the suitable pairs, are blessed with the rains and the flowing waters out of the Tsur. The illumination is provided based upon our associations B'Churab, and without such, the level of illumination will ultimately lead us to be B'Churab. The mountain of Shoyir/Seir flames with illuminations to formulate our unions to be the offspring/𐤀𐤔 of the Neúwn's eternal consciousness/𐤒, unto the Qudash-Barnao the state of Light. In Qudash-Barnao all that comprises our Union of Names arises without compromise unto eternal life. This is the hope, the YahchleAL, in the house of Zebúwlan belonging to the ALhhim of the Hhúwa-Gammal [Mishneh Túwrahh/Deut 1:2; Yahushúo/Josh 19:13].

Having now arranged the 11, we are engaged into the activities of filling the Lands and developing every trait of Seeds within all members. The activities are according to the patterns B'Churab unto which we have come. From Churab we proceed unto becoming a living intelligence, designating all concepts unto AR to rise unto AL. Every transmission of thought is to be productive *for the Name of ALOZAR*. In accordance of being a living intelligence, the ZAYIN appears from the well (basin in the garden) to speak and to bring forth the perpetuation of the Seed to fill the Lands with every trait and expression of ALOZAR.

According to the vibration of the thought, some Seed assemble in the House of Wisdom and some in the House of Understanding, and some in the House of Knowledge. For in that we are a soul—we are of an assembly of ALhhim in that our Names are an assembly of the Paired Letters. Yet until we activate the assembly of our Letters, we are yet to become *a life giving Breath*. With the structure of our associated Names, we have the foundation to activate the assembly of our thoughts as a *life giving intelligence* according to the work of AL, setting into motion to transmit the ALPHÆH unto AR and to bring forth the full traits/fruit unto AL.

The ZAYIN is the tongue to extend the thought from one end to the other through which ALOZAR sows and speaks revelations of the ALPHÆH fully, continually bringing forth the words of the Lights. The ZAYIN speaks to sow and bless. With the ZAYIN, the Seed extends

the NEUWN, thereby being called and read to be ZAYIN/זַיִן —the instrument from one end unto the other to extend the NEUWN. From the vibrations of the ZAYIN, words are spoken; the Seed is sown; the bees hum; and the serpents hiss.

As the ZAYIN is positioned to be servant of the NEUWN there is no arrogance of form nor speech, yet if it speaks on its own, the member dishonors the Breath with haughty speech and proud mannerisms. In that the ZAYIN is the member to completely activate the soul, it's number is 7, and it belongs to the House of the ZAYIN-ALPHÆH which is the house of RAÚwaben, the seven eyes (complete vision) whereby everything is seen from end to end as the eyes of YæHúwaH run throughout the entire ARets/Land [ZecharYah 4:10; Bayit Dibre HaYamim/2 Chr 16:9].

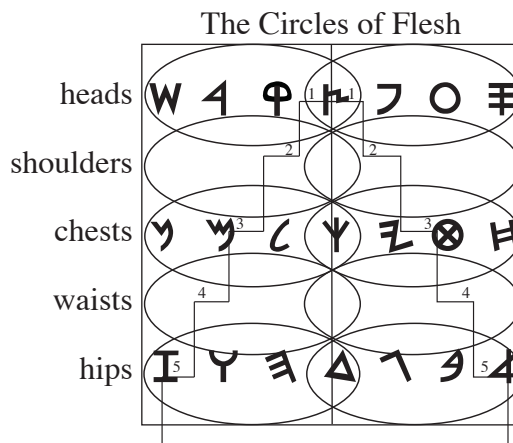

The Letter ÚWAW, first appearing in the midst of the NEUWN, is bonded to form the House of the ALHHIM of the ÚWAW-BAYIT. As the MÆYIM, beneath which it sits as the great basin or the kaiyúwer/laver, the ÚWAW gives of itself as the NEUWN and the MÆYIM, whereby it is called and read to be ÚWAW/ΥΥ which is called and read to the Unity perfected. The ÚWAW follows the Zayin as the ears follow the eyes via which a house is built for every thought and every Name. Thus Yúwsphah, of the MÆYIM takes hold of Shamoúnn (Simeon) and retains the force of UNITY to secure the transfer of B’Niyman from one state unto another. Thus the ALhhim of the United Pairs of the ÚWAW-BAYIT is the house of Shamoúnn, and the faculty of hearing which is always in the midst of the tongue and the eyes. With perfect Union whereby there is no hesitation to render our full giving of all that is within us, our ears are opened fully to hear every sound and pitch of the Letters of Light. For when the ears are full of materialization or accept gossip or degradation, they are stopped-up and the sounds are muffled.

The BAYIT, is then the counterpart to the ÚWAW through which all complete sayings coming off the ZAYIN tongue are composed into a collective of Names having 4 parts for the unified sides of the DALLATH Teraysarun. The BAYIT is called and read according to all which is given to extend the Unity unto a totality of the Sayings. Hence, with the BAYIT giving/זַיִן comes the TAÚWAH/× at the same vibration, for when there is an extension of two, the TAÚWAH appears in their house of unified order. For if one desires for the TAÚWAH to appear within them, then they must give all that they have for the full expression of the ALhhim. In that the BAYIT/×זַיִן, being the BODY union of all complete sayings is the TAÚWAH—the joined strands of two/×. As two strands are united, they receive the four faces whereby there is an apparition of the TÆYTH. The TÆYTH appears as the two houses/זַיִן are joined head to base which makes a complete heart of devotion to ALOZAR. As one takes two BAYIT and unites them together, the TÆYTH appears, which is joined forever to the MÆYIM.

In the assembly of uniting strands, the heart beats as ONE HOUSE whereby it is awakened unto ALOZAR. Out of the heart centre of the TÆYTH the ALtar of sacrifice is built by the two



united strands. According to the pattern of the TÆYTH, there are 4 horns/corners of the ALTar and all of the parts of the sacrifice are arranged in four sections which are the four openings of the heart. The TÆYTH/×ϩ⊕ appears, and its Name is called and read to be a free flow of thoughts/⊕, being of a complete/full giving and not hindered by any quadrant missing/ϩ, through which the united strands compose and renew/× those assembled as one. As two strands give of their assembled members completely upon the ALTar, they are renewed as the TAÚWAH whereby they are a complete entity of Light, according to the pairs of ALhhim. Each composed vibration of the heart is a thought of mercy and joy whereby the BAYIT is filled with reoccurring thoughts of Unity. In the perpetual flow of giving is there renewal. The perpetual flow of Light creates the 4 quadrants of the month, according to TÆYTH. According to this pattern of ALhhim, there are 4 quarters of the moon through which all is given unto its fullness.

The ALHHIM of the ZAYIN-ALPHÆH scan the entire Lands, keeping watch over the Houses day and night. Within the ZAYIN-ALPHÆH abides the first born of Wisdom, RAÚwaben. Within their sphere of observation, abides the ALHHIM of the ÚWAW-BAYIT in which the house of Shamoúnn resides. Within the Houses of Wisdom, abides the ALhhim of the Hhúwa-Gammal which provide the residence for Zebúwlan. Within the midst of the ALhhim of the Double DALLATH is the house of Nephethli that meditates upon all that is seen and heard and contemplates upon all states of our dwelling. The Union of the DALLATH and the KAPH are the united branches of Nephethli of DALLATH and Gad of KAPH. In the DALLATH Daúwid finds the place for the ALTar of sacrifice through which the offerings arise and fill the Teraysarun with thoughts of the Shayh. For in the DALLATH are the offerings of the heart that arise upon the ALTar of incense. These two ALTars are the Double DALLATH, each being comprised of the four corners of the TÆYTH. In these ALTars abide the ALhhim of the DALLATH in ALOZAR. With these ALhhim appearing, the Letters are revealed to be called and read.

X  
W 4 ϩ ϩ ϩ ϩ ϩ  
γ ϩ ϩ ϩ ϩ ϩ ϩ  
I ϩ ϩ ϩ ϩ ϩ ϩ ϩ

In building the Altar of the The ALhhim and setting into motion the perpetual sacrifice within our consciousness, there follow an igniting of the two strands of Names whereby the SHAYIN appears in their midst. In that the paired Names have given all unto each other, to affirm their position as Light in ALOZAR, they are acceptable as the offering of each day, whereby they consume each other through the Fire/SHAYIN. The same occurs when any two thoughts of ALOZAR come into contact with one another, a Fire burst forth in their midst where by the branches of the thoughts are consumed totally in the Fire and the former states become incorporated in the midst of the Fire. The Fire that is from the beginning is now brought forth from within the united sticks of Light, for a Fire results when two sticks are flicked (flare, vibrate, glow) together.

The SHAYIN is paired with the SEMEK whereby all Principles arising from the ALPHÆH are ignited and fill the 70 spirals of consciousness. As the Principles of the ALPHÆH-ZAYIN flow through the menurahh as racing thoughts, they are encountered by the SEMEK-SHAYIN which brings forth the Light of the SHAYH to fill the Temple of YæHúwaH. The ALPHÆH, as it rises into the SEMEK, spirals right to left. As the ALPHÆH is opened within the MIND, there is a burst of Light, and the combustion of the opened Seed yields a gas that is ignited by the SHAYIN. The SHAYIN swirls left to right, thereby causing the entire space of consciousness to be filled with the SHAYIN of the HHUWA. For there is the OYIN of the HHUWA and there is the SHAYIN of the HHUWA. The Light of the SHAYH encompasses both aspects of the HHUWA, in that the OYIN is always within the SHAYIN, and according to the OYIN the Seed opens. As the Seed opens there is the flash of the OYIN Light/HHUWA, yielding a luminous gas, being of the phosphorus/a pitch which is then ignited by the SHAYIN which fills the Haikal/Temple with the Light of the SHAYH. In that the Light of the Lamb becomes radiant, there is no more need of a moon or sun for the two have now been consumed into the UNIFIED consciousness of the pairs of the ALhhim, and the former is no more. This process of burning is how the entire cities of Sodom and Gamarrah are consumed with brimstone/×Ṛ 4ṚḂ and fire/WṚ as the Fire rages from Shinar/ 4OṚW whereby the OYIN MIND/ 4O is engulfed by the SHAYIN/ṚW. According to this Union of the Lights, Bayinah is within Chækúwmah eternally. When the OYIN MIND opens through the passing of the ALPHÆH amidst AL and AR ,there is the transmutation in the Land of Shinar, and the 70 spirals of the United Names are filled with the SHAYIN of the HA, being the Light of the SHAYH.

The House of ALhhim, of the SHAYIN-SEMEK, houses the tribe of DAN in that there are no openings of thought and no consummations without discernment/judgment. It is the House of Dan that causes the Fire in the eyes. The consummations of the SHAYIN occur through fully setting ablaze the ALPHÆH SEED. The complete igniting of all within the ALphæh is the full expression of the Fire. The Fire consumes all properties of thought, whereby the glory and radiance within the ALPHÆH are released without limit. Through judgment, the Fires come out of the Names and the Light of the Fire changes the faces of the ground. In the account of the judges, it is the judgement of Shimshun (Samson) that sets ablaze the SHAYIN whereby the former is no more. Shimshun is moved by the Reúwach YæHúwaH into the Machanah/Camp of DAN to enact judgments of YæHúwaH [Shophetim/Judges 13:25; 13:2]. The acts of Shimshun pertain to the body of the lion, in which is the honey of the SEMEK. Shimshun turns the asses together of the *shuolim*/ṚṚṚṚṚṚ/foxes, and sets ablaze the fire of the SHAYIN/300/W into the midst of the corn and the oliveyards of the Philisti. The lion and the 300 foxes belong to the House of the ALhhim of the SHAYIN-SEMEK [Shophetim/Judges 14:8; 15:4]. However; when the House of Dan, portrayed by Shimshun becomes entangled with the Philisti, one becomes as a mortal of clay; the eyes of RAúwaben are lost, and one is taken captive.

The Judge of the SHAYIN-SEMEK is the King in the Land, and the only King that is given to YishARAL, for the House of DAN maintains the order of the ALhhim and all affairs of the Kingdom of ARAL. In that Dan is the offspring of Shayin-Semek, **Dan is the glory of the Fathers**. The blaze of Dan, as the sun, fills the universe.

The Fire reveals the thoughts of the RAYISH, causing them to dance upon the

vibrations/flickerings of their united base, as they arise from the Altar. As the OYIN encircles the RAYISH, it folds itself upon the thought and begins to clothe the thought with the spinings of the night, whereby the SEMEK appears in the day as the strands, being drawn out, and then multiplied by the united pairs. The ongoing activity of labor within the Lights—to encircle the thoughts and to house all things together as one—is the House of Yishshakkar which dwells in the ALhhim of the RAYISH-OYIN. The pairing of Yishshakkar and Maneshayh is portrayed in the position of the Letters of the MÆYIM and RAYISH, showing that the RAYISH is within the MÆYIM as all thoughts arise from the waters upon which soar. The RAYISH are frequency of the vapors of the MÆYIM even as Yishshakkar is within the Maneshayh whereby all transitions occur through the works of the Lights.

Within the SHAYIN-SEMEK is the weavings of the RAYISH-OYIN conveying that all thoughts are structuring of the Fire. With these spirals of ALhhim are the inward pairs of Quphæhhh-Paúwah and the Double TSÆDDA.

The TSÆDDA runs out of the Houses of ALhhim in which is the rod of Nephethli and Gad. Thoughts run upwards from the DALLATH, in which abides Nephethli, and from Kephúw in which abides Gad, as twisted vines that run in united strands. As the thoughts run, their branches extend, and upon their sides are the fruit of the PAH waiting to be tasted. In accordance with branching the of thoughts of Unity, one is fruitful in their Union of Light Names within the worlds of ALOZAR. Thoughts outside the united strands, are unproductive and come to an end as there is not the sustaining flow of Light to maintain their occupancy once one enters into the covenants of Names in ALOZAR. Through the running of thoughts, spaces are created and then filled with the vibrations of the glory and spectrum of the Lights according to the classification of thoughts and their categories. Through the vintage of whole and perfect thoughts generated through united strands of Names, they fill their lands with three primary categories of thoughts measures by waves of Wisdom, Understanding, and Knowledge.

The extension of the thought—being of the ALhhim of the TSÆDDA-TSÆDDA configuration of Light, is the means to elevate a thought from a Principle Seed unto Seed becoming a Head. The Head becomes discerned by forming a neck of the GAMMAL ALhhim. The GAMMAL becomes an apparition of Light as it lifts up the Head that has formed at the crown of the Seed, whereby the Head is offered upon the Altar of sacrifice. Through the offering of the Head, one *affirms the wonder of all that is within the composite of thoughts.*

The GAMMAL of a thought ascends through the rising of the CHAYIT which adorns the neck of the NEUWN. Upon the opening of the neck of the forulative Head, all that has been multiplied within the Head is brought forth unto expansion and the freedom of expression. In this manner, every thought, as it is cultivated within the Union of Names comes to a Head. As the head ripens, the fruit is opened to reveal the expansion of Seed that has occurred during the Heads formulation. That which is within the Head is a verification of the Light that has formed it whereby the House of Ayshshur is born within the TSÆDDA-TSÆDDA. In this manner, the Unified Names of AL and AR, and their offspring, are fruitful and multiply. As a result their Lands



are filled with the glory and the spectrum of the Lights. Thus, as one considers the multiplication of the TSÆDDA-TSÆDDA, one beholds the PAÚWAH-QUPHÆHH upon the branches.

Every thought that is brought to a Head is the means to bring forth a Saying. Through the sayings, one governs the lands, for the sayings are the decrees of AR and the teachings of AL. According to the Sayings of Light, those being the scepter of the Kingdom, one has mastery in the Yevusi State of the OYIN-ZAYIN. Thus within the TSÆDDA-TSÆDDA abides the House of Ayshshur, which is the verification of all extended. Within the Quphæhhh-Paúwah is the firstborn of enlightenment, the House of Yahúdah. For as the QUPH is the offspring of the LAMMÆD, so is Yahúdah the firstborn of all instruction, being of the loins of Aharúwan.

Thus the TSÆDDA is called and read to be TSÆDDA/𐤀𐤃𐤁, meaning the transmutation occurring within the DALLATH-DALLATH Principle. For what commences a thought, being a Seed, arises within the PAH, the mouth/Saying of the priest/Quphæhh, to be a Saying of the expanded Principle of ALhhim. As the words of our mouth are the same as those in ALOZAR, we speak mouth to mouth and rule the lands with the scepter of Yahúdah.

The Union of the Quphæhhh-Paúwah are the means to distinguish the quadrants of a thought and the quadrants of the month. The Quphæhh, being the value of 19/10 is the sum of the 4 Faces/quadrants of the PAH/17/8, whereby the PAH contains the Sayings of the TSUR as two are united into the single dominion of the QUPHÆHH. The formulation of the fruit of the mouth is in essence **the bringing forth the Sayings of the QUPHÆHHH/Priest to be upon the lips**. As one bears the fruit they carry forward the words of Knowledge. In so doing, one takes possession of the land/space in which the Seed is sown, for with the fruit the land is possessed for the House of YishARAL to be full of the Sayings of the branch to which it is given. Likewise, as the expressions of our tribes fill the spaces in which they reside, so are the spaces possessed by the traits within the Words of Light. In this manner we are to possess the lands, as we are to take the land by quarters. The possession of the Lands is under the direction/staff of Aharúwan, as one who possess the Sayings of the Quphæhh-Paúwah House of ALhhim. The House of ALhhim of the Quphæhhh-Paúwah is called the priest's quarters. The Paúwah/𐤀 is a quarter of the Quphæhh/𐤀. There are 4 quadrants within the Quphæhh, two per side. According to the mouth of the Priest all things are made known. Each quadrant of the Quphæhh is 1/4. The four quadrants comprise the Quphæhh/19/10/1, whereby they are one House—4 quarters =1. The Union of the Quphæhh and the Paúwah are united base to head as the Zayin-Oyin body, as the Paúwah has arisen and become united in the head of the Quphæhh. Through this union, all values with all spaces is known, whereby the House of Yahúdah is born of the ALhhim.

Herein are 12 Pairs of ALhhim and their members, being now the apparitions of Light fully manifested to occupy all States in the Name of ALOZAR.

X

W	4	𐤀	𐤁	𐤂	𐤃	𐤄
𐤅	𐤆	𐤇	𐤈	𐤉	𐤊	𐤋
I	𐤌	𐤍	𐤎	𐤏	𐤐	𐤑

### THE CHILDREN OF ALHHIM

The Names of the Branches of Thought  
 RAÚwaben, Shamoún, Z'bulun, N'phatli

*The Names of the tribes are the Households of the ALhhim* [Elohim, Gods] from which comes the phrase “the Children of ALHHIM (God).” Each pair of the ALhhim brings forth the offspring of their united thoughts, whereby the offspring are also brought forth by pairs. According to these pairs we enter into the tavah/ark that is lifted up unto the heights of the mountains by the waters—the Mæyim/מ activities.

**The Letters are united pairs of ALhhim which give birth to the Houses of Yaaqov (Jacob). The twelve houses are the branchings of perfect Unity. Thus they are holy and chosen to receive the inheritance of ALOZAR, for in them the**

Activities of the Mæyim are 40 whereby the phrase “forty days” is rendered; but the number of sequential days is not what is meant. Rather 40 days are the activities of the Mæyim, being 40, which is *the value of receiving insights*/Oḡ into all that AL transmits/מל to AR/44, whereby the word, forty is composed as מלOḡ44, and uttered as AR'bog'yim. The number of the days in which Aharúwan and maShayh are upon the mountain are 40—the number of days



The four houses of the ALhhim encircle that which is in their midst. These are the rings that form the spirals in with-in the Stone of DALLATH-DALLATH arising from the square base, as the Teraysarun, within the encircling Oyin consciousness.

signifies that they are engaged into the inquiries concerning the fullness of the ALhhim. According to the inquiries, they ascend the mountain as they are called to come up higher. For if they do not seek, then they do not find; if they do not ask, there is none to answer. The 40 days commence when one prepares themselves to receive the rains of the House of AL and to unfold the messages of AR. As one leaves their captivity, they prepare themselves to enter into a new state of consciousness in which their houses are rearranged unto the pairs of thoughts and Names. As they have so prepared the ark of their mind, the rains of the 40 days commence.

**The Letters, ZAYIN AND ALPHÆH—יז, are united pairs of ALhhim. This Unity gives birth to the House of RAÚWABEN (Reuben), the branch**

The tribes are the branching of the Mind, being **the composite of united thoughts** whereby there are two eyes, two ears, two sides/ends/parts to every members, according to the House of Two Letters United, from which every tribe is brought forth. The design and the placement of each united house within us is according to the frequencies of the Light, which yield the music and the sayings of the paired Letters of ALhhim. The tribes live within us as they are united to the ALhhim, otherwise they are estranged into foreign lands.

The **Name of RAÚwaben/יזיז** is formed as **the foremost expression of LIGHT** through the transmission of the ALphæh/ז to the RAYish/י. The Name, **RAÚwaben/יזיז**, is called according to the results of the Rayish receiving the ALphæh, for when the mind receives the Seed, the Seed opens and their is sight—a burst of Light. The Thoughts created **by receiving and birthing the ALphæh/ז** are housed in **the offspring/יז of RA/יז**, whereby the Name of **RAÚwaben/יזיז** is formed. According to the ALphæh being joined/י to the RAYish/י, there is LIGHT/AUR/יזיז whereby one's eyes are opened to see. Until one receives the ALphæh in their Thoughts they are blind, having yet to open the Unity Principle of Wisdom within their thoughts. As the PRINCIPLE SEED of AL is received and opened by the Mind, one is able to behold all that is within the Seed. As the Seed opens, the firmament is created, and its size is according to the Light within the Seed. Every day there is a SEED THOUGHT that determines the scope of one's vision. It is the Seed of Light, created in each House, that leads to every activity of Light. For what is in the eye comes into the hand, and accordingly, the eyes birth wickedness or righteousness. As all Seeds of the ALhhim are received and opened within the Mind, one enters into the full firmament/expansion of Mind according to all that has been given of ALOZAR.

**The Letters, ÚWAW and BAYIT—יז, are united pairs of ALhhim. This Unity gives birth to the Shamóunn (Shimeon) the**

The **Name of Shamóunn/יזיז** is comprised of the Letter, Shayin/W which is formed by the House of the double ÚWAW. For when two are joined, the Fire abides within their midst. The Fire/W is depicted as the double-U, signifying the bonds of two sticks united—the doubling of the ÚWah/יז. The Union of two Names, positioned according to the Mind in ALOZAR, brings forth the Shayin/W which flows amongst them as the Mæyim/יז, whereby those joined are called by a Name/יז—**an understanding flow of Fire**. The Oyin/י in the Name of Shamóunn is the consciousness of the first level of four sides that are United/י to the full extent of vision depicted in the Neúwn/י. Thus, if one can see, one can

hear; for the seeing opens up the thought whereby what is within the thought may be comprehended/heard. Thus the Name, Shamoúnn, is derived by the Letters ÚWAW-BAYIT which are within the rings of the ZAYIN-ALPHA, in which the Name of RAúwaben abides. Thus we may say that inner circles of hearing abides within the outer circles of vision. The Shayin and Mæyim in the Name of Sh'moun are within the ÚWAW as noted above. The Letter, Oyin/O, arised from within the Bayit which is the House of Sh'moun/hearing. The Letters of ÚWahNeúwn/ׁׂ are derived from the House of **RAúwaben**/ׁׂ׃, whereby one hears according to what they see. As the House of Shamoúnn is the body of RAúwaben, the ears are the place in which one comprehends all that the eyes see. Moreover, as Sh'moun is joined to RAúwaben, Understanding is joined to Wisdom. Once a Unified Principled is received, it comes to birth as a House of Understanding. The ears become the body of the eyes as a stem becomes the house of a seed when it is opened. This Union of the eyes and ears is the foundation of the Shayin/Oyin Union through which all things are made and appear. As Wisdom/Shayin and Understanding/Oyin unite, all worlds of thought, both of darkness and light are created. According to the Union of Shayin/Oyin, the Kingdom of ALOZAR and the Ten States of full extension, within the 7 rings of Light are made and expand to become the 70 spirals of consciousness. For if the understanding is darkened, then so is the world that is formed; however, if the understanding is whitened, then so is the world in which one resides.

The **Name of Zebúwlan**/ׁׂ׃ is comprised of the Letters of Zayin-ALphæh and the Name of RAúwaben which abides in the midst of the scope of Vision. For as one sees and hears, so is their house/Bayit. The House is ever expanding according to the consciousness entered into, thus their is the consolation of the Saying of RAúwaben: *“The Greater is always present to enter into.”* The Greater present exceeds any point/state/level for it encompasses the scope of the All Seeing EYE. As one beholds all within the full consciousness of ALOZAR, so the house of ALOZAR is complete. The Lammæd/ל within the Name is the pole of Light, known also as the Rod, that appears through the activities of the HA, upon which the serpents fix themselves to arise unto the gates of the Neúwn. Thus the scope/I of the house/׃ is formed/ׂ according to the level of ascension upon the shaft, being the Teachings/ל of the NEUWN/ׁ.

The **Name of Nephethli**/ׁׂ׃ is comprised of the Letters of RAúwaben, Zebúwlan, and Shamoúnn, for the meditation is upon what is seen, heard, and the states in which one resides. The letter Neúwn is from all drawn out of the states of seeing and hearing, whereby the Neúwn is the final letters in RAúwaben, Zebúwlan, and Shamoúnn, but the first in Nephethli. The Paúwah is from the ALhhim of the ALphæh for it is upon the Principle that one meditates and not upon the form. As one meditates upon the Principle, the Saying comes forth whereby the Paúwah appears. The Taúwah is the Totality of the Saying whereby the meditation is complete which provides the direction of doing. The final Letters in the Name are the Instruction of the Lammæd in the ALphæh and the Yeúwd, which is the level of mastery of the ALphæh whereby the full Teraysarun arises from within the well of the 70 spirals. The deeds are in harmony with the state of unity to which the

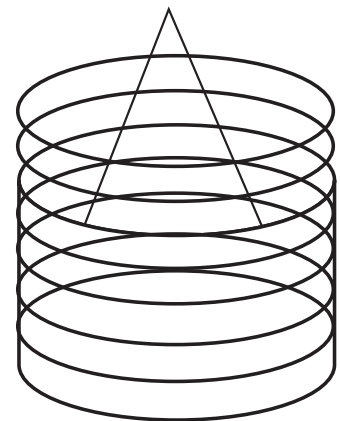

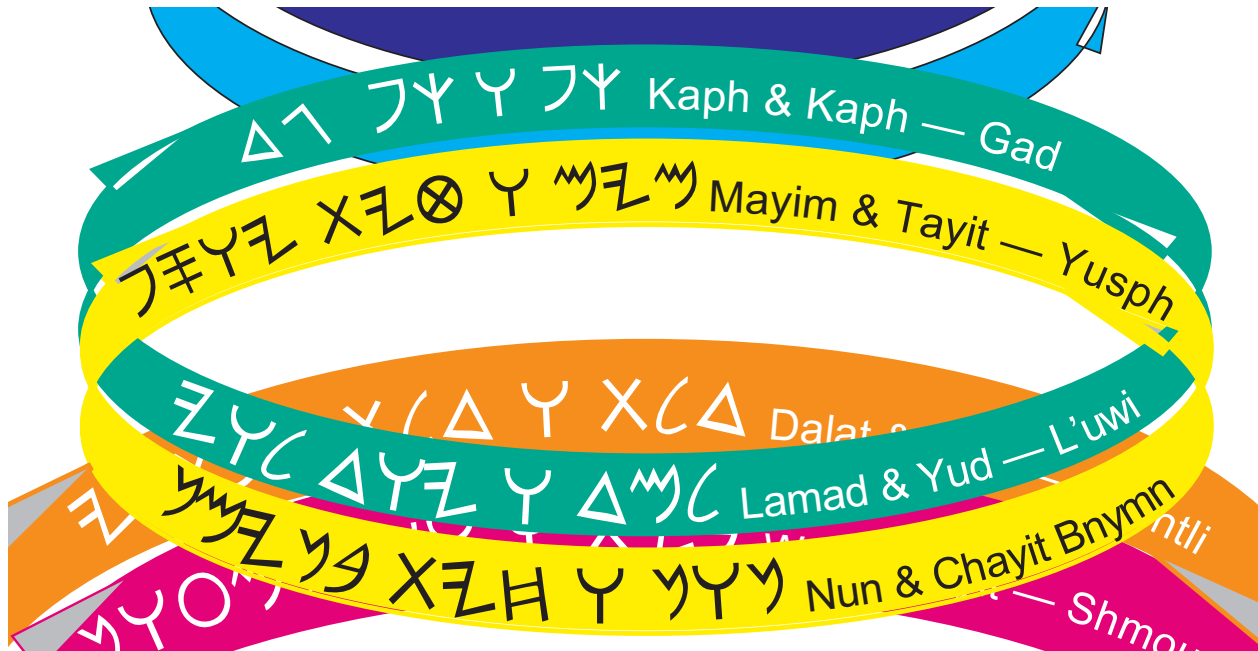

The four houses of the ALhhim which are within the midst of consciousness. These are the rings that form the spirals for the Tree of Lives which is in the midst of the Garden that lead us to unto the Breath of ALOZAR.

meditation leads us. For until we have drawn out the Principle to know how the saying is paired/Taúwah, we have not come to the end of the meditation. In accordance with the arrangement of the Letters, the Name is spoken: **Nephtli**, from which the word, *nphat*/X79, is constructed which means a hill, a height, and to drip honey whereby one speaks sweetly [Yahushúo/Josh17:11; Mishle/Prov 5:3; Shir hashirim/Song of Songs 4:11].

To draw out the state of transparency and immortality of Light, we must *nphat*/X79 unto the paired thoughts of the ALhhim whereby we are prepared to conceive and to formulate our joined Names into a new state of habitation. To put on the garments of the immortal, we must meditate and weave the joined sides together, for such is the garment of wholeness.

### The Names of the Branches of Thought

BeNiymaN, Yúwsphah, Laúwi, Gad

In the midst of the rings of the eyes, the ears, the coils of the great river of Zebúwlan, and the aspiring Teraysarun of the heart, are the Houses of the ALhhim of the NEUWN-CHAYIT, MÆYIM-TÆYTH, LAMMÆD-YEÚWD, and KAPH-KAPH. What is in the midst of the 70 rings provides the core information whereby all thoughts branch forth. Like a vine, the inner circles of Lights supplies strength to that which branches at its sides. The branches connected to the most central core are the Names connected to the inner most circle of ALOZAR. The connections amidst the branches are the means to expand a Seed unto maturity whereby it bears forth fruit. The most central core ring of ALOZAR extends from the feet unto the crest of the mind upon which sits a crown of ten points, a crowning tip for each of the ten inner spirals or



lands that the Names rule over.

There are two rings beneath the inner rings, those being Zayin-ALphæh/ÚWah-Bayit and Ha-Gammal/DallathDallath, and two rings above, Shayin-Semek/Rayish-Oyin and Quphæhh-Paúwah/TsæddaTsædda. The centre two rings are those of Neúwn-Chayit/Mæyim Tæyth and Lammæd-Yeúwd/KephúwKephúw. In the midst of the centre rings is the crowned ring of ALOZAR. These are the rings of consciousness, being seven they are complete. The Ring at the crown extends from end to end in the midst of the rings which is in all and through all.

In that from the centre rings all rings beneath and above come forth, we may say affirmingly that the inner rings extend to cover all that comes forth within them. For in that the rings come from the midst, they are carrying within their circles of thoughts the pattern of that which is in the midst, and hence in this manner, one is never far from that which is in the midst if they so desire to turn inward. In this awareness, we may say assuredly that ALOZAR is within and yet all is within the Mind of ALOZAR which comprises the OYIN consciousness of all thoughts and Names, deeds and ascensions.

Within each ring of consciousness, there are ten spirals, whereby the ten lands are in each ring of consciousness through which one attains/receives via the Qayin unto the mastery of the Yevusi. Even as there are 6 pairs of rings in each house so are there 10 spirals within each ring whereby every part knows the position, the strength, and the wonder that is in each house. Through the associations of parts and spaces, there are full communications between all parts. The ten spirals within each ring are the fibers of thought, of which are the lands in which the branches are given to abide/possess/regulate according to their Names and deeds. The activity of the Lights each month weaves the layers of fabric within the ring that pertains to the month. As in the month of Maneshayh, each quarter activity of light weaves a pattern within the quarter of each tribal ring until the *shavbetut* of the months are complete when the ring is filled and the warp is complete. The thirtieth day is the weaving of the thread that connects the circle of the camp to the adjoining circles. Thus during a course of a year, the entire fabric of consciousness is renewed within all camps even as the body renews its cells and as a serpent renews its skins. The renewal of the fabric within each ring enables us to enter in the levels of full consciousness in ALOZAR whereby one escapes the damnation and partiality of their former consciousness.

The rings of consciousness are within each other. As they expand as the trunk of a tree they reveal the 70 spirals of consciousness. The rings conform to the states of their residence whereby they may be coiled together or extend as a strand of light to be woven together. As the seventy rings/cups are within the center shaft of the menorah, they unfold into the fully branched thoughts of the paired ALhhim. In beholding the 70 spirals one discerns the unfoldment of the coiled up DNA strand of Light within every cell.

In view of the UNITED ORDER of ALhhim, we war against all nations, their governments and their peoples/consciousness within their lands in order that the House of ALOZAR be no longer divided between the reflective and the actual States of Light. The war is the gathering together of the children of ALhhim unto ALOZAR to abide within the expanding firmament of

consciousness to express the fullness of all Names in the domain of Light. This is a war not of the weapons of human artillery, but of the Fire/Shayin that comes forth from the mouth of the serpent, to devour all that enslaves, unto the freedom of all Names in Light.

The Names in the centre Letters of Understanding are formed within the Houses of the ALhhim out of which they are called/read. Thus we read **BeNiyman** as the House of the NEUWN, being the first body that is formed amidst the ALhhim whereby those who are born of the NEUWN carry the designation of the Ben/בן. Within the House of the NEUWN is the YEÚWDMÆYIM, for the one of all grace/חַסֵּד has within the their hand/כַּף the pitcher of oil/מִנְיָה to anoint all unto their full extension/measurement from which one is called to be Yahushúo Ben NEUWN. The YEÚWD reveals the full giving of the NEUWN whereby it is extended to the 10th power/כַּף through the distillations/vapors of thought/מַחְשָׁבָה that are within the NEUWN/בן. When every two implement the full extent of their Names, the YEÚWD is within them whereby they achieve their full measurement of being. For by the YEÚWD, one is lead through the stages of development unto their full measurement of being in the Lands of Light.

The **House of Yúwsphah** is the other side of the ring of B’Niyman for from the sides of Yúwsphah the Seed of B’Niyman takes up residence and makes itself a house. In this is the saying of Yúwsphah, “The House is other side of one’s thought, for the house shows what is in the inside of a thought whereby what is in the inside becomes the outside.” According to this saying, we know that the House of YæHúwaH is built according to that which is read within every House of ALhhim whereby the House is complete. According to the UNITY of the MÆYIM-TÆYTH, also called the devoted waters, the YEÚWD, being the Rod/Scepter of the Kingdom, is given to Yúwsphah to activate the SEMEK unto the PAH. The ÚWAH in the Name of Yúwsphah conveys the union of the waters whereby there is One House. In accordance with the Union of the Waters, the YEÚWD extends through that which is in the midst through their deeds whereby the inner structure of the Sayings, come upon the lips. The Knowledge arising upon the lips is through discerning mouth/PAH to mouth or from gate to gate/PAH. According to this means of revelation is the saying of Yúwsphah: “The inner structure of a house is known by the mouth, from which comes the Sayings of ALOZAR.” In this manner maShayh brings forth to Aharúwan the Sayings of the Breath which are interpreted by the Illumination, that is, unfolded, to give Light unto all YishARAL.

The **Name of Laúwi** is the Staff within the Hand or the LAMMÆD that is within the YEÚWD. According to the Union of the LAMMÆD-YEÚWD, all words and teachings are placed within the hands of the Laúwi. As the LAMMÆD-YEÚWD are fully extended, the Principles of the ALphæh, being the base of the YEÚWD, and the Fire of the Shayin, being the crown of the LAMMÆD, are in the mouth of the Laúwi. This is the full extent of the teachings of the Laúwi whereby their is totality as ALphæh + Shayin = 22.

The **Name of Gad** which resides within the House of the Laúwi is born of Kephúw. The DallathDallath within Nephethi rises which is conveyed by the GAMMAL to form the Name, Gad/גָּד. One speaks of that which is in the Teachings of the Laúwi as they are contemplated upon in the heart. Through the heart, that which is in the midst, rises upon the lips. Thus all

messages, as they are discerned from mouth to mouth pass through the heart, and from the heart they are uttered according to that which is written within. Thus all records of Light are first written within. The writings of the sayings through our hands aid in recall and are for attainment of the Yevúwsi Head, as a discipline of the heart through which all is spoken by Gad. As all the words are spoken from the inner scrolls, the Tree of one's Name, being the Tree of Lives



The four houses of the ALhhim which rise from within the midst of consciousness. These are the rings that form the spirals for the fruit to from upon the Branches, revealing the complete structure in which the Word Seed abides.

of a Name, is fully extended. These trees are the wood of Lebanon with which the House of YæHúwaH is built.

The Names of the Branches of Thought  
 Dan, Yishshakkar, Yahúdah, and Ayshshur

The **Name of Dan**/ד, belonging to the ALhhim of the SHAYIN-SEMEK Union, is formed as the DALLATH/ד pierces the Neck of the NEUWN, through which the words from the heart are released to come upon the tongue. Through the Fire of the SHAYIN, all that is within the Teraysarun and the branches of the Tree of Lives rise in the midst of the Haikal. As the essence of a Name rises, the glory/values within fill the chambers of United Names. The NEUWN/נ in the Name of Dan is the throat opening/נ of the Teraysarun/ד through which the voice of the Resident Name is heard. The Fire of the Voice comes out of the Gate of the Neúwn as a Judge rises from the chamber with a decision of discernment/judgment. When the judgment is given, the decision to put to death or to let go is declared with authority. As we are to overthrow or to devour what has hindered us, the Fire within the Voice of the Judge sets the overthrow in

process. However; if there are yet deliberations, then the Fire holds that which is question to be yet in captivity. When the Fire breaks open within the Voice of Pharaoh, from all that Aharúwan has declared, then the voice of Pharaoh, echoes the Order of Aharúwan, and that which is bound is set free. From all that Dan utters, so are the sayings of Pharaoh, for it is the decision within the mind of the house that permits the words to be uttered. In this correlation, Pharaoh is the judge of all that is deliberated within the House of Dan/Breath.

Within the Union of the ALhhim RAYISH-OYIN comes forth the **Name of Yishshakkar**/ 4YWW𐤃. The Name of Yishshakkar comes out of the RAYISH-OYIN Union, which depicts the head of each body. The YEÚWD/𐤃, being the initial Letter is the head of doing/implementation of values, and from the level of our performance comes the compound nature of the ALhhim SHAYIN-SEMEK thoughts that are opened through Dan. There is no doing/YEÚWD, unless there is a decision what one should do and how they should perform. One engages in idleness because there is no Fire under their feet, conveying that discernment is not present. It is the YEÚWD, or the Hand of the Judge that takes the gravel and affirms the decision spoken. This is the Hand of Yishshakkar that affirms by one's deeds the decisions of their heart that has arisen through the neck and set ablaze the mind to speak and to perform that which is according to the full nature of one's Name. The double SHAYIN in the Name of Yishshakkar is how the Fire spreads through implementation. The SHAYIN is doubled by the ÚWah that joins SHAYIN with SEMEK. The KEPHÚW in the Name of Yishshakkar comes out of the SEMEK and conveys that the Fire is spreading out amongst the Branches of Mind within the RAYISH. As a thought is performed, so the branch to which the thought belongs spreads as a tree.

The **Name of Yahúdah** is comprised of the Dallath in the midst of the Union of the Lights—the HhúwaÚWahHhúwa/𐤃𐤃𐤃. The HaÚWahHhúwa form the crown of the mouth/𐤃𐤃 for by the Union of the Lights/𐤃𐤃 all things are governed both in thought/𐤃 (night) and/𐤃 in deed/𐤃 (day) [Sepher Maoshah B'rayshith/Gen 1:16]. As the Dallath of Nepheth rises by the activities within the HhúwaÚWahHhúwa—the Union of the Lights, the Name of Yahúdah is born within the Sayings of the Priest/𐤃𐤃. The birth of Yahúdah within the Ring of the Quphæhh-Paúwah is the piercing of the crown of enlightenment via which the first sacrifice of the kohen is made. The Hhúwa is the foundation of the Quphæhh, as the crown is opened in the Mind of ALOZAR, the sayings come forth, whereby the Paúwah appears. Within the Sayings are the Unified Words of Light in which are born then all praises, values, declarations of truth, which comprises the House of Yahúdah. The Name of Yahúdah comes forth as the mouths of the Kuwáhnim/priests peak all that within the Mind of ALOZAR. All mouths are within the Quphæhh; as the Sayings of Light are spoken, the first born of the Sayings is the House of Yahúdah.

With the sacrifice of the Laúwim comes the awareness of the habitation of all Names—the associations of ALhhim. The ALhhim, as they are united within the Mind of the Laúwim, bring forth the acceptable offering of Yahúdah, which is begotten within the Quphæhh-Paúwah and resides amongst the Priests/Quphæhh and the Prophets/PAÚWAH of the House of YæHúwaH. The Unity of all ALhhim provides the final oylah offering of the Shayh/𐤃W brought forth by the Hands of the Kuwáhnim [Malaki/Malachi 3:1-4].

All that the Ones of YæHúwaH have thought will yield the finest of the harvest of all Names at the end of the age. *The final harvest is the offering of the Lauúwim, for the ones that are formed first in the Mind of AL are the last offering to be made whereby they are the first—at the head of the new worlds also. The offering of the Lauúwim usher in a new age/world, for out of every complete offering comes a dwelling state of enlightenment that exceeds or goes beyond that which is given by unified parts.* The new world comes out of the offerings of the Lauúwim as new works and progressions come out of hands and feet of every oylah. In that the hands and the feet of the oylah offering are washed after the pieces and head of the offering are arranged upon the altar of sacrifice, so the procedure of the oylah signifies that at the end/conclusion/result of the offering of the oylah is a new creation [TeúwratHhaKuwahnim/Lev 1:9]. The extensions/legs of the offering are the means to carry forward the intent of the thoughts of the offering. The new creation is comprised of the new works/deeds and progressions **which come out of the total union and exercise of the ALhhim that comprise all Names.** For in that the dwelling of the old worlds is due to partial offerings that are made, **the new worlds are formed by the complete offerings of the paired Names of the ALhhim, which include every Name that belongs to the Union of the ALhhim.** The new state of residence is formed by the fingers in the midst of the Fire—those being of the hands of the oylah; the new state of residence is entered into by the feet of the oylah. The Shayh/אָW belongs to the Union of the Lauúwim that have in their hands the Rod/feet/Lammæd of maShayh with Aharúwan—the Rod comprised of the Ha/אֶ-Neúwn coupled unto the Lammæd-Shayin/W with Enlightenment (Aharúwan).

The **Name of Ayshshur** comes forth as the Sayings of Fire are spoken. Ayshshur abides within the ring of Yahúdah which provides affirmations of every value of Light, as the TSÆDDA-TSÆDDA, are within the ring of the Quphæhh-PAÚWAH. The TSÆDDA/אָΔ is the Totality of the ALPHa comprised of the values of 22 (Δ (4+18=22) to bring forth the evidence of the Seed/אָ. The TSÆDDA/23 + TSÆDDA/23 Union of ALhhim yield 46/1, conveying the ALPHÆH being born upon the branches of liberated thought. As the ALPHÆH arises within the Mind, the Name of Ayshshur is born within the TSÆDDA-TSÆDDA. The totality or 22 of the Seed in TSÆDDA is the Fire of the ALphæh-Shayin/Wאָ in AYSHSHUR/אָWאָ, for when a tree blooms and bears the ripened fruit, it is the Fire breaking out upon its branches, from whence comes the saying: “The Tree is ablaze with its glory.” The bearing of the Seed within the Mind is Totality/22 (Wאָ (1+21=22) within the Rayish Head/אָ, signifying the liberation of the Seed and the coming unto mastery is through the offerings of the Quphæhh-PAÚWAH.

Sayings of the 12 Houses of ALhhim

### The Sayings of RAúwaben, of the House of Zayin-ALphæh

“The Greater is always present to enter into.”

## The Sayings of Yahúdah, of the House of Quphæhh-Paúwah Sayings of Ahhav (Love)

Sayings of the Houses of Light are the States of Their residing, for all worlds are spaces of the thoughts according to their kind. One abides in a world created by their thoughts. If the thoughts are transparent, so is the world of their occupation.

“If one is embarrassed by the good-will expressed of another, then the one embarrassed is yet apart from the good-will of another.”

The acceptance of AHHAV from another is to be in-love whereby love is both the subject and the action [noun and verb] of one’s associations.

The Ahhav/Love of ALOZAR is the giving and receiving in the midst of AL and AR and all that dwells within the space [domain] of Their Love. Basically, Love is Service to another, with pure motives for the full expression of Light.

To abide in the world of ALOZAR is to dwell in a State of Total Giving [in the Oylah Offering], being without ownership or attachment to the things of the world which violates the Liberty of the whole communion of Names. The Oylah offering is our most rational service that we render to the House of YæHúwaH.

Cannot the Winds gather up the Breath of any state and thereby change the nature of its shape? All that belongs to the Wind/*Reúwach*/Spirit are at liberty to abide within in a space that is designated by the Wind; however, when one resides where the Wind has not appointed, there comes into that state a confusion and bondage. The Wind carries the Names to dwell in an appointed space whereby the space becomes filled with the thoughts of Their Names to reside freely together.

“The Wind filling a thought creates a place of occupation. Therefore, what one gives their Breath unto is the State in which they reside.” For as one speaks, their Breath fills the thoughts spoken and thereby creates a State according to what is spoken. To change a state, one must withdraw their Breath, by inhaling their Spirit from within a thought that created the space, as a whirlwind, which takes the air out of a house whereby it collapses.

“It is the acceptance of AHHAV/אָהָב/Love whereby the giving of Love becomes the action of one’s thoughts. *For as one receives, so one does.*” My Name hereby accepts the thoughts of complete Love whereby there are no attachments, for all attachments to the things in the world restrict the Breath to a static state which causes corruption. For if any are attached to the things of the world, they are without the Liberty of ALOZAR. The on-going exchanges in the midst of ARAL are without attachment to the things in the world, for all such attachments exalt a Name from another. The attachment of any part from the whole is leavening, which denotes that corruption is within the thoughts, and if within the thoughts, so within the spaces that are formed by the Breath filling the thoughts. To speak with Breath empowers and fills one’s thoughts and

thereby recreates a space according to what is spoken.

*“Love is the Union of total acceptance without attachments to the things in the world, whereby the Breath is free to give totally within the whole of of ARAL [the Kingdom of YishARAL].”*

*“In Ahhav/Love there is no fear, nor want of anything; for through Service to all, we enter into the ongoing exchange and communion of Life.”*

### **The Sayings of Gad, of the House of Kephuw-Kephuw**

“The one who walks upon their words is not a true soul.” Do not give your pearls to those who trample them underfoot—walk over them.

“Those who fulfill their words are upright and trustworthy of all things.”

### **The Sayings of Yúwspah, of the House of Mæyim-Tæyth**

“The House is the other side of one’s thought, for the house shows what is in the inside of a thought, whereby what is in the inside becomes the outside.”

“The inner structure of a house is known by the mouth, from which comes the Sayings of ALOZAR.”

### **The Sayings of Aparryim Sayings for Blessings**

“A Seed Thought expands to reveal all traits/colors and expressions of the Seed.”

### **The Sayings of Maneshayh Sayings for Transitions**

“Whatever you turn your faces toward is what you become and where you will go.”

Through what house have you migrated into your present body? How were you transferred here? According to where the seed is placed, so is the body that is born from the mother into which it is sown; if sown to the flesh, it will reap flesh, if sown to Breath, it will reap the dwelling of Breath. If sown to the flesh it will yield the iron/clay consistency.

Queens are the body of consciousness through which the Principles are transmitted. The concepts pass through the Eyes/Rings of Wisdom and Understanding via which the Seed of ALOZAR is carried according to the consciousness prepared to receive them. The level of consciousness determines the dwelling state and the ability to receive the Seed of AL. There are no female and male reference points, as there are no such divisions in the mind of ALOZAR. In attempting to equate the process of transmission to the mortal bodies, one stumbles and falters in the path.

Transference of state of Seed is through Yúwsphah/Joseph and the union of the necks of Beniyman/Benjamin. The Unified Will/I, Maneshayh, dwell in their midst and carry the Seed, as the sacs of Beniyman.

Exchange of pearls is at the union of the necks whereby the most costly gem of great price is guarded by the two sides of Light, as denoted by the two rings of the shell clam. The black pearl is the gate to the worlds beyond and is passed neck to neck.

### **The Sayings of Yishshakkar, of the House of Rayish-Oyin, Sayings of Duty**

The one who studies for themselves will come to nought, but the one who studies for the sake of others will be eternally fruitful.

The one who feeds others will be fed; the one who stores the grain and does not impart it for the Knowledge of Light within the sheepfold shall lose what they have.

The deeds that come out of the hand is the blessing that comes upon the head, for the thoughts that motivate the hand are multiplied by the doing of them.

### **The Sayings of Dan, of the House of Shayin-Semek Sayings of Equality**

“Seven pairs comprise the wholeness of complete thoughts. The seven pairs are the seven rings of consciousness, each being of two sides united, in which are seventy spirals. One pair of the unclean comprises partiality or incomplete thoughts which are for the expansion of Unity, being two yet to be joined. An incomplete/unclean thought is a part that is in process of being joined or made whole” [Sepher Maoshah B’rayshith/Gen 6:19-22, 7:2-3].

“What is of partiality is unclean—being of parts; what is born is whole—being of mashiy-ach. The whole is an assembly of the unified parts and becomes evident when the inward parts are joined and identified to comprise the whole. So are all Names that are united made clean as they are the inward parts of ALOZAR. When the interior, being the Numbers within the parts, is not known, the parts are unclean as the swine.

The unclean depict the state in which the concepts are not grasped/swallowed/internalized but yet remain apart from the the whole expression. The unclean is forbidden/restricted by the illuminated to enter into the Mishkan—the Tabernacle of Light. Being not of the association of parts the comprise the Haikal/Temple, the unclean cannot enter for there is no space in the Haikal for a part or Name that is not joined, in that all spaces in the Haikal are designated for associated Names and non-partial thoughts.

Food that is unclean is not accepted within one’s house on account of the soul/expression, for an unclean thought yields incomplete expressions. Thoughts of partiality yield expressions that are bound to the mortal and weighted down with corruptible matter; therefore, they cannot enter



into the immortal states. To be bound to the mortal is by associations of partiality. Being partial keeps one unclean because one feeds upon that which has one part but not the other, as the fish, that have fins but do not have scales; they are unclean unto your totality. When the whole/perfect associations come, the unclean or partial is done away” [SepherMaoshah Sh’lichim/Acts 10:28-35;40-41].

“The Fire of Shayin governs, as a Lion, unto the uttermost rings of a Thought through which the Fire of the Shayh/אָשׁ both fills the inner spaces and defends the spaces from all unclean. The Fire is the Breath of the Enlightened One of Dan—which arises as a Judge—to both fill the House with Light and to defend the occupied States.”

“Every true judgment is based on Equality.”

### The Sayings of BeNiyman, of the House of Neúwn-Chayit

**“Grace brings full extension; the Túwrahh brings full revelation.”**

“Grace comes and flows by favoring the Mashiyach—the full communications of Life whereby all that is within becomes fully extended in all activities of Light. Therefore, it is stated that the Mashiyach comes by Grace—by favoring the inward. The Túwrahh comes by maShayh/Moses/אֲשָׁח—through drawing out/חָצוּ all details of the Shayh/Lamb/אָשׁ. As one favors the inward, the Mashiyach commences to grow. With the expansion or growth occurring through grace—full favoring, spaces are provided for the details of the Lamb to be known and written. In like manner, as a tree is given grace to extend the Seed unto its full branching, the complete inner structure is revealed. *The favoring of the Seed and its full extension yield to the revelation of all that is within the Seed. All that is within the Seed is the Túwrahh.* Grace is given that the Seed within every Name may open, whereby the Tree of Lives within every Name may grow unto its full measurement. As the Seed of the Tree is favored, the words held within the Seed appear as the tree branches. This branching is the bringing forth the Word of YæHúwaH—the Seed of ALhhim.

The one who does not seek to change the world into which they enter, shall be conformed unto it.

A worm enters into the hole that it came out of, so are the mortal. A Name arises as a sharrif with the Fire, transforming itself as a Seed of Light.

### The Kingdom Comes as a Sower Sows the Seed

**The Seed** of the Word of ALhhim is a composite of the thoughts of ALhhim. Each Seed has within it a complete set of thoughts, perfectly organized in pairs, being the thoughts of ARAL—*lit.* the Light of AL, the foundational basis of the Name of Malki-Tsæddaq/מַלְכִי־צְדָקָה (Melchizedek); The Unified Name of the Priest/AL/אֵל and King/AR/אַר from which all is given and unto whom all returns with blessings.

Every Seed is of the *ALhhim*—the House of Unlimited Concepts every expanding and revealing the Principles of Light. A seed is a composition of the messages of Light, being an assembly of unified concepts that gather/bond together to become unfolded/revealed. Within every Seed are a foundation/base and a Head. As the Seed is opened, the full consciousness that is contained within it is revealed. This is the meaning of the word, zaro/O4I, a word formed by the Letters that comprise ALOZAR/4IO4, expressing that every Seed of Light come from AL (God).

Every day within a month Seeds are formed within the House in which the Lights are tabernacling. For example, in the ninth month, Seeds are formed upon the branches of BeNiyman (Benjamin). The **paired conceptual thoughts of AL are transmitted and received** by the opening of the mouths of AL whereby the concepts are given unto those receptive. The pairing of the Lights, as the pairs of evening and morning make a day, is the way that a Seed is formed. The thoughts that are gathered from evening unto morning are the gathering of the thoughts of the Queens, whereby every Seed has within it Wisdom/Chækúwmah/W and Understanding/Bayinah/O. The Queens depict the fruit in which the Seed forms and from which it is passed unto a new state. The Queens, which are a chamber in the midst of the Priest and the King, is as the heart in which words are formed. In that the properties of Shuo/shua/OW are within a Seed, the very nature of salvation is inherent within a Seed.

Through four quadrants of the month, which are four mouths/openings, the concepts are spoken as they pass from AR to AL. The passing of the Seed from one end unto another is via the ZO/ZayinOyin in the midst of AR and AL, and therefore; Lights of Night and Day go from one end unto the other end. Out of the mouths of AL we receive the Principles of the Light. They are spoken and as they are uttered from the Qadam/East each morning, they are gathered into the sacs of Maneshayh each evening. As the Seeds are withdrawn out of Maneshayh, they arise unto the Mind of AL, having now come full circle. For until one returns unto AL, they are yet to be born, being half-baked.

In that the Seeds are uttered paired Principles, there are two sides of a seed coat showing that the properties of both ends are gathered and sealed for the joy of revelation. As a Seed has been sown from the east and then returns to the east, the Seed is readied to be opened, or what is known “to be sent forth for expansion—the revelation of all details of Light through which a house is formed.” Every Seed is sent forth according to the illumination in which it is sown into the mind for expansion/explosion. According to the releasing of the Seed, so comes the quaking of the ARets. As each paired thought combines and forms a Seed during the days of the month, so a Seed is born within a month; however, when the Seed is spoken, it is the day of its conception until it returns to the Mind. In this manner, every Name is formed. When a Name is completed—having become united as Chækúwmah and Bayinah, it is called by a Name that encompasses its two sides/parts and is readied to be sent forth, two by two, for expansion and blessing. Thus all Names come from the heart of Auwer, as they are in Mind united to the ALPHa of AL. Until that union occurs, each one wanders seeking a resting place. Hereby is the birthing of all of YishARAL and the prophecy of Yeshoyahu/Isaiah (chapter 60).

Every Seed belongs unto one of the Houses of the ALhhim for it is the product of the union of two Letters or two thoughts or two Names which are joined for blessing and expansion. As the offerings are made each day, so the two Houses of ALhhim, in which are Bayinah and Chækúwmah, combine their thoughts to form a Seed. Out of the nucleus within the Seed, comes forth their thoughts, being intertwined, the house that is built cannot be divided. In this manner, a tree draws out of its nucleus the intertwined thoughts of night and day, whereby it withstands the winds and becomes as a mighty oak. So are all who are united in the Houses of ALhhim.

The two Houses of Light for each day formulate a Seed. For example, on the Rash Chadash of Maneshayh, the oylah offering is made by the governing rods of Maneshayh and Yishshkhar, whereby the Seed that is generated is according to the thoughts within the Union of the ALhhim, being those of the ALhhim MÆYIM-TÆYTH in which abides Maneshayh, and the ALhhim RAYISH-OYIN in which abides Yishshkhar. In that the Seed is conceived and born by the opening of the mouths, for two mouths must open for conception, and two mouths must open for birth, the Seed born belongs unto the House in which it appears upon the branches of the Tree of Lives. Hence, when the Seeds are born during the month of Maneshayh/Manasseh, they belong to the Houses of the ALhhim MÆYIM-TÆYTH. For during the season of a year, the branches of the Tree of Lives bear their fruit according to the season/month of the Light which is in the Mind of AL. According to the mouth of the Patriarch, a Name is proclaimed as one born within the Houses of ALhhim, for in the House of its birth, the Names come forth to reveal all of the glory of the ALhhim—the Principles of the Light that are contained within them. For who can discern the Name that is within a body except the Mind of the Patriarch from which the Names are born. The month in which a Name is born is the season of the Mind of ALOZAR, *a season that is beyond the scope of this world/age*, hence not restricted to the months of this world. In the Mind of ALOZAR are all the months of Light, and each Name/Word comes forth according to the month of its revelation/birth. Accordingly, all Names belong to one of the Houses of the ALhhim. Thus a Seed may be spoken in one month but born within another, for the concepts may be held unto they arise by the quickening of Illumination and Breath that causes them to ascend into the Mind and then to appear upon the Branches bearing the fruit of YæHúwaH for the season of their birth. In that a Seed is born within a day of a month, the Seed thereby gives its Light in the Union with the Lights of the month in which it is born, thereby being of the same Light of the month in which it appears. When a Seed is opened, that is the Day; the Word of unified thoughts that composes the Seed, begins to shine.

According to the Letters that form a Word, we know how each Word/Name is formed and to which of the Houses of ALhhim a Word/Name belongs. As we look at the Letters of each Name, we behold the thoughts of the ALhhim that combined together to comprise the Seed of that Name/Word. In considering, when the Seed is sent forth, which is the month in which it is born—when the Seed is opened, we determine that the Seed belongs to one of the Houses of Knowledge, Wisdom, or Understanding. Thereby we know that each Word or Name belongs to a branch upon the Tree of Lives which bore the Names/Words amongst the families of ALhhim. Hereby, each Word Name is appointed unto the families of the ALhhim to which they belong and to the lands in which they are to reside unto their full unified expression of Light which composed them.

For example, the House of the ALhhim LAMMÆD-YEÚWD/𐤀𐤅𐤅 bears forth the Union of the thoughts of instruction unto doing—the implementation of the instruction. The combination of these Letters LAMMÆD-YEÚWD of ALhhim form the word of Laúwi, which belongs to the LAMMÆD-YEÚWD House of ALhhim. In that the Letter, ÚWAH is present also, the Name, Laúwi is formed as there is comprehension, to hear the Instruction unto Doing. When this level of hearing is achieved within a Name, the House of Laúwi is awakened and is born within the Name. When the House of Laúwi is awakened within a Name, the Name then belongs to the teachings of the Laúwim, and from these teachings they will not depart for they now know inwardly that these are the teachings of the Tree of Lives. As all nations awaken to the voice of the Priests and Laúwim, they will come to the mountain of YæHúwaH, to the House of AL of Yaaqov, and in this awakening, the Túwrahh will go forth from Tsion and the Word of YæHúwaH from Yahrushaliem [Yeshoyahu/Isaiah 2:2-4].

Should a word be of the Letters of SHAYIN, MÆYIM, and ÚWAH, as in Shamu/𐤅𐤌𐤍, then the Name belongs to the House of the SHAYIN-SEMEK, the MÆYIM-TÆYTH, and the ÚWAH-BAYIT, which conveys that the Name is of the Fire and the Water/Oil/Distillations being joined to convey the Eternal Flame of Light. Should a Name contain the Letters of ALPHÆH and LAMMÆD, being 𐤀𐤌, then the Name has been formed directly within the Name of AL and belongs to AL. Should a Name contain the Letters of SHAYIN, MÆYIM, and OYIN, then the Name denotes that it is a composite of the thoughts of the Fire, Water/Oil/Vapor, with full consciousness of Understanding.

In that every Seed is a composite of thoughts, it forms a Word, whereby a Seed is called the Word of ALhhim in that it is comprised of the unified Letters of ALhhim. In that every Seed is a formulation of the combined thoughts of Light, every Word and Name is bearing the Mind of ALOZAR. To insure that every Seed is opened, there will be rain and snow, cultivating and harvesting, until every concept of ALhhim has been opened and the Words, which are the Seeds, are spoken from the Mind of Light [Yeshoyahu/Is 55:10-12]. When a Name/Word is spoken by the Mind, the Light within the Corporate Name fills the body in which it resides, for the Seed has now been formed and opened whereby the Light within it shines beyond the lights of the sun and moon that formed it in the womb of consciousness. As a Name is born, it comes forth with the fullness of blessing and Understanding [Yeshoyahu 60]. For every Seed Thought, being of the mouths of ALOZAR, will return unto the Mind that spoke it that it may be shouted from the housetop. In this way Aharúwan spoke all that was in the loins/waters of maShayh, whereby the Words that come to dwell within the Shayh arise into the Mind of Illumination.

What is within a Seed is able to arise out of darkness and reveal the Light in which it is composed. In the midst of the Letters of the NEUWN-CHAYIT/𐤅𐤍, meaning grace, is the word, 𐤀𐤅, meaning “to be able, full of capacity, competent, and overcoming.” Hence, as we favor the coming of the Mashiyach within these vessels we are able to arise above the state of corruption and damnation in which we have entered and into which our fingers have mingled with the waters of this world/age. The mashiyach arises/comes/appears within every Name, which is known as Yahushúo/𐤅𐤍𐤅𐤌—*the complete extension/𐤅 of the United Lights/𐤅𐤌 of Chækúwmah/Wisdom/𐤍 and Bayinah/Understanding/𐤅 within every Name.*

The fingers are the works of the United ALhhim (Elohim/Gods). According to the pattern within the 8 Letters of HhaTsur/the Rock, so are the fingers 4:4, being 8. The fingers are the extensions of the United ALhhim. The Union of the Fingers of Knowledge with the Fingers of Understanding bring forth the evidence of the Principles of Wisdom, whereby the Rings of Knowledge, being 18, and the Rings of Understanding, being 4, affirm the Totality (18+4 = 22/Taúwah).

The fingers each depict a 90° movement of thought, whereby the left hand makes a full circle of Understanding and the right hand makes a full circle of Wisdom. Together, the four fingers comprise the rings of the stars. The 90° movements/placements are observed in the 70 Names and the relationship of one House unto another.

### The 1:1 Ratio

In accordance with the Achadd/Unity of ALOZAR/ΑΙΟΖΑΡ, there appears a 1:1 ratio within the Letters that comprise the Name of ALOZAR. The Value of the Letters of ALOZAR are counted by Principle/Chækúwmah to be 56; by Knowledge—the Crowning Glory the values are 308, and by Bayinah/Understanding the sum is 11. Whether one counts values within words by Chækúwmah/Wisdom to see their primary essence, or by Doot/Knowledge to see their radiance, the reductive value of Bayinah/Understanding is the same, for 56 reduces to 11, as does 308 reduce to 11.

## THE FINGERS OF ALHHIM

4 :4 Configurations of HATSUR/אֶתְרֵא

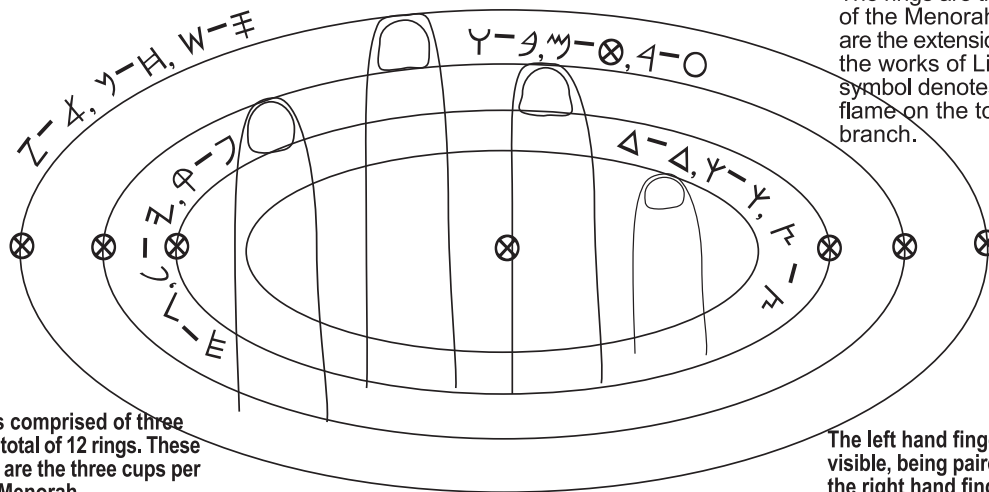

The rings are the 7 branches of the Menorah. The fingers are the extensions to perform the works of Light. The ⊗ symbol denotes the four-fold flame on the top of each branch.

Each ring is comprised of three levels, for a total of 12 rings. These three levels are the three cups per side of the Menorah.

The left hand fingers are not visible, being paired and joined to the right hand fingers.

Each finger is of four parts. The Fingers of the Left hand set the position for those on the Right:

The Pointer/Index fingers (left side) work according to the pools/waters/basins of the Mayim-Tayit, those of the (right side) are appointed unto the Quph-Pah and Rayish-Oyin which arise out of the Lamad-Yud of the Kohanim; The Impudicus/Middle fingers extend into the (left) Nun-Chayit unto Shayin-Samak, (right side) Ha-Gimal out to the Zayin-ALpha; The Annularis fingers extend into the (left) Tsada-Tsada from the (right) Waw-Bayit Houses; The Auricularis/little fingers extend unto the (right) Kaph-Kaph from the (left) Dalet-Dalet.

We enter into and become the States that we touch, for the one who touches the clean/paired is clean, and the one who touches the unclean/partial is unclean. The term, to touch, means that which is agreed with, through which the thoughts and all members are extended. The fingers comprise the hands; the base bone of each finger is Wisdom within the Hands; the heads of Wisdom are the 4 pairs of knuckles; the heads of Understanding are known as the 4 pairs of the distals. The 4:4 Ratio pertains to the extensions of the two paired stones that comprise the ROCK. These two sets of 4 sticks, are the eight primary boards around which the veils of the Mishkan are woven. Sepher Yetsiat Mitsraim/Exodus 8:19, 26:25; 31:18; YeshaYahu/Isaiah 17:8; Tehillah/Ps 8:3, Yusaph/Luke 11:20

With the eyes of Understanding, we behold the innermost value of 11, the Kephúw/Υ, in the midst of the Name of ALOZAR, and see that in the most blessed Name of Names is the Tree of Lives/Υ which abides in the midst of the Garden of Letters. The Kephúw/Υ, being the value of 11 by Chækúwmah, and the value of 20 by Doot, is the value of 2 by Bayinah. Herein lies the order of the House of Light, for all things are arranged by pairs, or by 2, according to the Mind/Rayish/20/2 of ALOZAR, from whence all words come through grace, without restriction.

The ratio of 1:1, being the balanced state of Oneness, is within every House of ALOZAR. The Houses of ALOZAR are known as the ALhhim, which are formed by joining two Letters together. Within the Union of the Letters all Names and Families are born. **The twenty-two Letters are called the Houses of the ALhhim.** The Letters, as they combine, multiply the thoughts of Achadd to reveal the complete Mind of ALOZAR. The Letters comprise the Words of Light. *Through the eyes of Understanding we discern that all words of ALhhim are according to the value of 1:1.* Through the Unity of the ALhhim, all Names/Words are formed and become uttered or carried forward by Breath.

In that the Words are unified Light thoughts, they proceed day and night without sound, being carried by the spectrum frequency of the Lights in accordance with the position of the Lights in respect to one another. *Our ability to hear these Words, as they proceed day and night, is in relation to our being aligned with the positions of the Light.* **The alignment with the Lights is accomplished by the full giving of the oylah—the perpetual offering each evening and morning.**

All thoughts of the ALhhim are clean, meaning that they are complete, lacking nothing. Each word thought is comprised of two sides, or parts, or pairs. As each Letter belongs to another Letter, they house within them the 1:1 ratio. Likewise, the words formed by their unions have within them a 1:1 ratio. Through the union of the Letters come forth the words, which are begotten of ALhhim. In this manner, all Names are the children of ALhhim.

A word is written with Letters and spaces. In former days, the words were joined one to the other to convey a continuous flow of thought, and not separated by spaces as appears today in modern languages. The spaces within the words are the means to weave the Letters together into a fabric of Light. When a word is uttered, the spaces amidst the Letters are likewise uttered, for though they be heard or not, they are carried with the Letters. The spaces amidst the Letters are conveyed in the vocalization of the Letters, whereby they are sounded within an opening or space of the throat. The mouth and tongue conform to be according to that which is amidst the Letters proceeding from the gate of the Neúwn. In Paleo Oovri, we do not refer to the Letters as consonants or vowels; we know the Letters to be Signs and Numbers. Through the Numbers we discern the value of a Word, and according to the combination of the Signs and the Numbers, the words are uttered inaudibly or audibly. The utterance of Light consciousness conveys the 1:1 ratio that is in the midst the words, whereby **what is spoken are words of the Tree of Lives.** These words of Life are acceptable to the encircling movements and intentions of the Breath, whereby the tongue, as a spear or scepter, is given the power to speak of life/animation or death/extension.

The manner of determining the sound of the Letters and the spaces between the Letters gives various utterances of the Breath. *The Breath/Reúwach/Spirit/Intelligence of ALOZAR, and those who are aligned mouth to mouth, speak the words to denote the presence of the 1:1 ratio, being of the harmony and sweetness of the Mind of ALOZAR.* According to this harmony, the Words are read together as musical scores of a ten note scale within an octave, according to the 1-9 threads, or values, to which every Letter belongs in the House of Bayinah/Understanding.

Pronunciation of words is according to the interior harmony of values/numbers within the Letters. In that there are 9 strands of Numbers amongst the Letters, so the primary or basic value of the Letter is used to compute the frequency of Light in sound. For example, the ALphæh/𐤀, Yeúwd/𐤁, and Quphæhh/𐤂 carry the value of 1, 10, and 100 respectively, which are the three 1's amongst the Letters, carrying the value of the ones in the midst of three octaves. The Tæyth and Tsædda are two strands of 9, carrying the value of 9 and 90 respectively amongst the octaves of Light. The primary or basic value of the Letter is used to transfer the frequency of Light to be vocalized or heard, either audibly or inaudibly. Though one may be accustomed to read the Letters by the extended Numbers of Knowledge to compute the value of a word or the equations and ratio amongst the Letters, the result is the same in the eyes of Understanding. However, in that Chækúwmah is the Primary Values of 1 to 10, we use only the primary Letters to determine the frequency of Light, for all things are united according to the primary threads of thought. (Reference: "The States of Light: The Cardinals of the Letters")

### THE 1:1 RATIO IN NAMES/WORDS

The Name of ALOZAR/𐤀 𐤁 𐤂 𐤃 commences with the Letter, ALPHÆH which extends unto the RAYISH. The parameter Letters of the Name set forth the process of the 1:1 ratio whereby there are two, for the ALPHÆH being one is multiplied unto the RAYISH, being two. This the Union of AL and AR, being paired thoughts through which the whole may be known and expressed. The values and the ratio of the Name and the Words or the Names within **the Name of ALOZAR** are hereby set forth:

2 7 7 3 1    The Numbers  
4 𐤁 𐤂 𐤃    The Letters

Initially, the Letter ALPHÆH/𐤀 appears as the Head of the Word, being in the first place, and beside it stands the LAMMÆD/𐤄 which is how the ALPHÆH of every kind is sorted into families within the Orders of the Lights. These two Letters, being the Name of AL (common usage: El/God), are the Head of every thing in all worlds, for they are the beginning of the Order from which come the Laúwim/Levites, in whose hands the Staff is placed forever. The Union of these Letters comprise 4 which determine the 4 quadrants within a circle and the 4 mouths which are in the Mind of the kuwahn/priest/Quphæhh/𐤂 from which come the base and the ascending House/Tent/𐤅 of YæHúwaH.

3 1    The Numbers  
𐤄 𐤀    The Letters

The balance or harmony of these two Letters comes by their giving. What is in their midst is the value of 2. There are three Letters that carry the value of 2, the Bayit/𐤁, the Kephúw/𐤅, and the Rayish/4. The first to emerge out of AL is the Head, or the Rayish. This Head is what is known to be the Mashiyach, being the Head of all creation, coming from the Head of the Initiator/Giver/Creator. The Rayish is the Head of the Body/IO which appears in the midst of the Rayish and the AL as the ALPHÆH is passed from the side of the LAMMÆD unto the side of the Rayish. This passage from the LAMMÆD/Staff of Aharúwan to the RAYISH is through the Body of the OYIN-ZAYIN/IO. As the Zayin is aligned with the consciousness occurring in the midst of AL and the Rayish, the tongue/penile gland/Zayin transfers the SEED, ALPHÆH, to the MIND, RAYISH. The space between AL and the RAYISH is the formation of the firmament in which all thoughts flourish and expand to reveal their glory/radiance of Light.

The Rayish/4 is drawn out of the LAMMÆD-ALPHÆH/𐤀𐤅 Union,  $3 - 1 = 2$ .

2	—	3	1	The Numbers
4	—	𐤀	𐤅	The Letters

As the ALPHÆH SEED is passed from AL to R, the thoughts, Principles of Light are set in motion to comprise the 32 paths within the rings of Wisdom, being 4 each with the value of 8, whereby  $4 \times 8 = 32$ . The 32 Paths are derived from the Lammæd/30 + the Rayish/2. The drawing out of the Seed in its season/quadrant, or via the 4 mouths, yields the complete consciousness of all within the Head of ALOZAR, whereby the Body/Tent of Meeting/IO appears. In the Tent of Meeting AL abides in the midst of the people/collective consciousness of Names. The dwelling of AL with us (OmanuAL) comes with the building of the House of YæHúwaH, whereby the full Presence of ALOZAR becomes apparent. The Body of the Ten Letters— OYIN-ZAYIN union— is the Flying Serpent body aligned at the sides. The Five Letters of the Zayin, Chayit, Tæyth, Yeúwd, and Kephúw/Kaph are aligned with the five Letters of the Lammæd, Mæyim, Neúwn, Semek, and Oyin. These five to five comprise the Union of the Lights, written as the Hhúwa-Úwah-Hhúwa, or 5 united to 5, from which comes the Name of YæHúwaH in which all Names abide. In the Union of the Five to Five the tail is in the mouth of the Head and the full circle of consciousness from the foundation to the head fills the body, as the smoke and the glory fill the Tent of Meeting. The Body is carried by the wings of the remaining twelve Letters. (For further details, consult BHM document: THE HOUSE OF DAN.)

2	7	7	3	1	The Numbers
4	I	O	𐤀	𐤅	The Letters

Through an activation or giving of all within the House of AL (BayitAL/Bethel), the 1:1 ratio is established, and all things in the House bear the image/likeness of the Unified Names of Light.

10	1	:	10	1	:	1	The Ratio	
(2	1	7)	:	(7	3)	:	1	The Assembly of 10
4	𐤅	I	O	𐤀	𐤅		The Letters	



Amidst words of ALOZAR, the pattern of the 1:1 is carried forward even as traits of unity are passed from one generation to another. In reading the Unity of the Letters, the Sh<sup>e</sup>pahh B<sup>e</sup>Rurah/א 4Y 49א7W—the pure language is restored unto us collectively [Tehillah/Psalm 12:5-7; Zephanyahu/ Zeph 3:9].

The Letter ZAYIN, from which the ALPHÆH comes into the Mind, is written and spoken as perfect, or complete.

5 1 7    The Numbers  
 ז ז I    The Letters

In that the ZAYIN contains within its spaces the ALPHÆH, the Presence of the ALPHÆH is heard as the Name of ZYN is uttered as ZAYIN. **In that the ALphæh is the base of all Words, being the Seed of haALhhim, the frequency of the ALphæh is heard in every word uttered and the value of the Letter ALphæh may appear upon the tongue as the words are uttered as a 1:1 ratio.** The word, ALPHÆH, is summed as 111 (1+30+80=111). The three ones in the ALphæh are in the Presence in Wisdom, Understanding, and Knowledge. By the Presence of the ALphæh there is perpetual renewal, and the Offspring of the ALhhim are begotten, namely the twelve tribes/branches, with each bearing a fruit with the ALphæh Seed within.

7 : 7    The 1:1 Ratio  
 (5 1 1) 7    The Assembly of 4  
 ז ז ז I    The Letters

**A Letter within a word may be doubled** in sound to convey the 1:1 ratio. When a Letter is doubled it is said to be hard or to convey a firm sound. A doubling of a Letter may be equated to quickly hitting the same note twice in succession in a musical score. An example of a double Letter is the Dallath, whereby it is spoken as the Dallath. The sound of the Dallath is *dth*; whereas the sound of a Dallath is a hard *d*. The word, achadd, is uttered with a double D, whereby there is a 1:1 ratio amongst the Letters that comprise the thought of Unity/Oneness/Achadd: Δ א ז. The Numbers of the Word are (4)Δ, (8)א, (1)ז. In doubling the final Letter, the Dallath, the ratio of the Word is (8)Δ, (8)א, (1)ז. The ALphæh conveys that it is the means to give rise (8)א to the square base of the Haikal/temple, whereby the foundation becomes fully extended as the cube (8)Δ. Within the word, **Achadd/One**, the 1:1 ratio is the ALphæh/ ז to the Chayit/א and the Dallath/Δ which defines the ALphæh as the Unity of the 8+8/O, or the Unified Consciousness in the Oyin.

8 : 8    The 1:1 Ratio  
 (4 4) : (8) = 1    The Assembly of 16O/  
 Δ Δ א ז    The Letters

The most common Letters to be doubled are referred to as the B<sup>e</sup>gadK<sup>e</sup>pat/כ7YΔ79 letters, or those to be known mnemonically, but the process of repeating the sound, or striking the note

twice, is not limited to these letters, for the practice extends commonly with the HHÚWA, WAW, YEÚWD, LAMMÆD, and MÆYIM also. All Letters may be repeated to convey the full frequencies being rendered. In understanding the process of uttering a word, there is no need to rely upon the markings or pointings imposed upon the words, for those of clarity speak the same thoughts and utter the same words with understanding, and those not of the eyes of the offspring of Palua, an offspring of Sight—Raúwaben (Reuben), do not comprehend what is being uttered even if they can duplicate the sound of a word.

An example of a doubled Letter is in the word, Gomarrah. In this word the sound of the ancient Gayin conveys the hard sound of the Oyin. In that the Garden of YæHúwaH is in this land, one may see that the paired values, being 10:10, conveys the full extension of Knowledge within the sheaves/hagomarrah.

<b>10</b>	:	<b>10</b>	The 1:1 Ratio
(5+1+4)	:	(1+4+14)	The Assembly of 10/𐤒
א 𐤌 𐤌 𐤌	𐤌	𐤍 𐤎 𐤎	The Letters

The doubling of a Letter within a word appears in the Word, **ALhhim**/ 𐤀𐤋𐤅𐤍 (common usage: Elohim/Gods). This word is a compound word as it is comprised of the Name, AL and the Letters, 𐤀𐤋𐤅/Him, the later meaning to stir, make a sound, and that which comes from the Tree of Lives as in 𐤀𐤋𐤅. The term stems from the Union of the five to five parts in the OYIN-ZAYIN body. This Union of parts is conveyed as the two lights, or the 𐤀𐤅𐤀 configuration that emanates from AL. The bodies of luminaries spin from the ARAL Union—the sun from AR and the moon from AL. Together, all that is born of the kuwahnim/priests in the Houses of AL are called HhaALhhim. Those born of the pairs of ALhhim are the Offspring of the Lights and are united together to be YishARAL. The Letters that comprise ALhhim are (4) 𐤍, (10) 𐤒, (5 x 2=10) 𐤀, and (4) 𐤌. The Letter Hhuwa/𐤀 is doubled in pronunciation.

<b>5</b>	:	<b>14/5</b>	The Ratio
4 1 (5 5 3 1)			The Assembly of 5
𐤍 𐤒 𐤀 𐤀 𐤌 𐤌			The Letters

As every Letter is a 1:1 ratio of the Name of ALOZAR, so then words coming forth from the Letters, being the ALhhim of ALOZAR, are also a 1:1 ratio. In the word, ALhhim, the ratio is 1:1:1:1. The two ends, 4:4, are a 1:1 ratio. The sum value of the Letters in the Name of ALhhim is 10—the reductive of 1. These four one's are the primary Houses of Wisdom from which all thoughts arise. For until the concepts/seeds of the thoughts descend, they are unable to arise into Bayinah and bear the fruit of Knowledge.

<b>1 : 1 : 1 : 1</b>	The Ratio
(4)(1) (1) (4)	The Sum Value of 10/1
𐤍 𐤒 𐤀 𐤀 𐤌 𐤌	The Letters

Combinations of the Letters are the means to expand and multiply the Thoughts within the Mind of ALOZAR. The combined Letters are continuously interacting and exchanging properties whereby they are eternally radiating their Light, neither slumbering nor holding onto anything as

though it were of their own possession, but continuously sharing everything that they have as a flowing musical score played together by various instruments to carry the sounds/arranged frequencies. So is the Assembly of Names as one heart and mind [SepherMaoshah Sh<sup>e</sup>lichim/Acts 4:32]. The sounds of the Words are continuously being spoken inaudibly within the conscious mind and uttered audibly through the mouths/spaces/openings of our Houses. The words of Light carry the vibrations of the 1:1 ratio of Light as they are discerned and spoken through the Name of Shucham, meaning equality. Shucham is the Offspring of Dan, coming out of the Fires of the Shayin-Semek Union. In knowing the 1:1 ratio of every word, the Breath of Dan speaks 1:1, whereby every Word uttered is of ALOZAR, unto whom we give an account of all words [MattithYahu/Matt. 12:33-37]. *According to the Words of the ALhhim*, all things are appointed unto our Names [DibrehaYamin/I Chronicles 25:5].

The words of ALhhim carried within our Reúwach/Breath, whether audible or inaudible, are the thoughts of perfect balance and harmony. Through these words the worlds of Light, being the lands of our inheritance, are formed. The ALhhim are **The Principles—Seeds that Govern all things. Within the ALhhim are the OYIN and the SHAYIN, being the heads of the scepter of the two Lights/אא, whereby the ALhhim govern all thought considerations and activities. The words of Light are extended through transmissions/waters/ Breath distillations and crystallizations of unified thoughts.** The ALhhim are the Houses of Unlimited Concepts, ever giving, expanding and revealing the Principles of Unity. In the ALhhim are a multitude of Seed Principles that are cast into the firmament as the stars. As each concept or Principle Seed is opened, the nature of its Light is seen. In the opening of every word of ALhhim, the Light of the Shayh/Lamb fills the Temple.

The ALhhim are paired, as nothing of ALOZAR abides alone. In the pairing of the Names of the Letters, the full counsel of the ALhhim is declared. The unified word, ALhhim, is the plural form of AL—the United Order out of which come all Teachings of Light.

## The 1:1 Pairs of the ALhhim

### The Letters—The ALhhim of Wisdom

#### The Four Houses of Wisdom or the Four Families of the ZA/I א

##### ZAYIN-ALPHÆH/ א I

7 (5+1+1) 7	4 (5+8)=(3+1) 4	The Numbers
א ז א = I	א ז = א א	The Letters
7 : 7	4 : 4	The Ratios
	1 : 1	The Ratio of the House

Zayin, the Primary Letter of Wisdom, is the extension of the Neúwn, the Primary Letter of Understanding. The Zayin is complete as it gives the ALphæh, for until one gives from the Seed of their Name, that which is within themselves, they are yet to bring forth their wholeness. No

thought of ALOZAR, or that which is within a Name, abides unto itself. As a Seed, if it remains unto itself, it does not come to full expression/fruitfulness. To realize our complete expression of Name, one gives that which is within as their most rational gift to the House of YæHúwaH. The ALphæh is within the Zayin, whereby it appears in the formula of completeness/seven.

The ALphæh orders all thoughts with the Lammæd at its side/ℓℓ. According to the frequency of the ALphæh there are various kinds of species of trees and expressions. According to the frequency of the ALphæh the thoughts begin to run. All thoughts, species and forms come from One ALphæh, but according to the frequency of the ALphæh, so is the type or kind that comes forth. The Letters Yeúwd/1 and Neúwn/5, being 6, plus the ALphæh/1 = Zayin/7. The ratio may also be served by doubling the Yeúwd; however, the gift of the Zayin is the ALphæh which is within and upon the tongue of the Zayin.

Each House of Thought creates an eye. There is an Eye formed in the Houses of Wisdom and an Eye formed in the Houses of Knowledge. The third eye appears in the midst of the two rings, within Houses of Understanding.

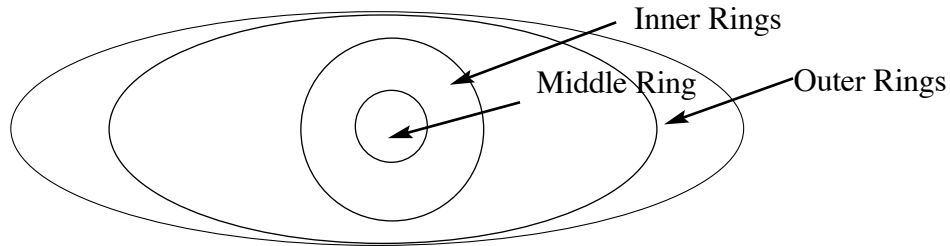

In that all levels of Thought are in Bayinah, within the consciousness of Light, the rings of Wisdom and Knowledge are both in the Rings of Understanding as the Zayin and the Shayin are within the Neúwn and all that proceeds from this triad of the Lights from which comes the moon, the sun and the stars.

W ----- 𐤨  
 ʁ ----- 𐤨  
 I ----- 𐤨

**UWAH-BAYIT/𐤨**

6 6 6 5 (4+1) (1+2+2) 5 The Numbers  
 𐤨 𐤨 𐤨 = 𐤨 — X 𐤨 = 𐤨 𐤨 𐤨 The Letters  
 6 : 6 5 : 5 The Ratios  
 6 + 5 = 11 — The Dwelling of ALOZAR  
 1 : 1 The Ratio of the House

In that there are two within every House, so the Bayit is doubled or hardened in sound. The ALphæh is within the Bayit, for no house can be formed without the Presence of the Seed ALphæh. As one dedicates their dwelling state to the Name of AL, they are honoring the ALphæh within them, which is the reverence or honor of AL. The formulation of the Bayit, or dwelling

state of Unity, comes from the United ÚWah/אָײַ which comprise One Body of Light/Hhúwa, for the Light appears when AL and AR are unite. The Bayit, depicting sheep and the body of ewe, is derived from the ancient Name of the Letter, ÚWah/אָײַ.

**A seed is formed by the northern lights creating a spiral of thought from the outer to the inner; a seed is opened by the southern lights creating a spiral of thought beginning within the center unto the outer.** In this same manner, the blood is placed on the altar. The blood of the evening offering is applied with the left hand, from the seventh outer ring of the heart unto its centre; the blood of the morning oylah is applied with the right hand, from the inner ring of the heart unto the outer ring.

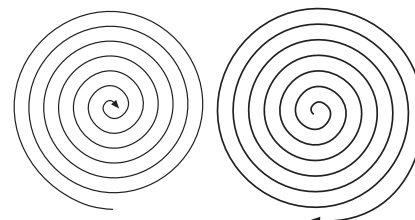

left: formation of seed and bringing a thought inwardly for the evening oylah; right: opening a seed and expanding a thought from the center for the morning oylah.

The Arabic number 4, comes from the two sided Bayit/ג. From this arrangement of pairs, comes the 4 faces in one Head/Rayish/4. The Bayit is the house of the ÚWah which is formed as the Neúwn gives completely of itself in the Chayit. What is drawn out from the sides of the Neúwn/14, being Chayit/8, yields the ÚWah/6, the state of Unity and balance.

The Value of 32 shows up in the configurations of the YEÚWD/TAÚWAH/אָײַ, which conveys the reductive of 5 or the Presence of Chækúwmah. 32 is the sum of the 4 Houses of Wisdom which is the result of adding together the 4 Houses of Wisdom, each being an 8.

### HHÚWA-GAMMAL/אָײַ

1	(5+5)	1	3	4	4	3	The Numbers
א	=	א	א	—	ל	מ	The Letters
		1 : 1			7 : 7		The Ratios
ל	א	מ	מ	א	א	8 : 8	Gammal, a rendering with the ALphæh
							1 : 1 The Ratio of the House

The Letter Hhúwa, is the full extension of the frequencies within the ALphæh, whereby there are two Letters of the Hhúwa. The Letter, Hhúwa, is in accordance with the Cardinal of ALphæh which is comprised as 1 = .5+.5, or א = א+א. In that the two Hhúwa comprise 10, the Lights within the ALphæh are drawn unto the Head of the Yeúwd. The Yeúwd indicates the full extension that comes by two united. From the Seed of your Name, has come forth your two sides. This is what it means that one side was taken from Adim to formulate Chaúwah, for from your north side has come your south side, or from your behind has come your faces. In that your body is the formulation of the united LIGHTS within your Name, you know inwardly that your dwelling is of LIGHT and that you belong to the LIGHT and therefore all of your expressions are of the Light, whereby there is no darkness within your temples.

The GaMmaL/א is an inverse of the LaMaDd/ל. Note the presence of the Mæyim in the midst of both Letters. In the GammAL formula, the ratio at both ends of the word is 1:1, with the

Mæyim flowing in the midst to transmits all between the Lammæd and the GammAL, or from the foot/staff/ℓ to the neck/∧. The Letter GammAL is a picture of a shepherd that brings the flocks to the neck of the well [Sepher Maoshah Bereshith/Gen 29:1-3; Sepher Yetsiat Metsryim/Ex 2:16]. The practice of giving one to drink and washing their feet is a complete service to another, serving them at both ends [Sepher Maoshah Bereshith/Gen 24:32]. Both the Hhúwa/1:1 and the GammAL/28/1 are comprised of ones.

The GammAL is the neck that is created by the thrust of the ALphæh as it passes from AL to AR: 4 \_\_\_\_\_ ℓ 4. According to the Lammæd/Instruction of the Priest of AL, the ALphæh passes through the GammAL to develop the Body of Mashiyach to reveal fully the Rayish/composite Mind. As the central Letter, Mæyim, is doubled, the formula is balance to be a ratio of sevens, for now the water has been served from both ends, whereby both the neck and the feet are served with the Mæyim — ℓʹ ʹ∧.

### DALLATH-DALLATH/ΔΔ

4	3	3	4	—	4	3	3	4	The Numbers				
X	ℓ	ℓ	Δ	—	X	ℓ	ℓ	Δ	The Letters				
	7:7				7:7				The Ratios				
X	4	ℓ	ℓ	4	Δ	—	X	4	ℓ	ℓ	4	Δ	8:8 With the ALphæh
													1:1 The Ratio of the House

The Dallath/Δ is as the GammAL/∧ in that the two ends are the 1:1 ratio with the Presence of the Lammæd in the midst of the Union. As with the Lammæd, if one speaks the ALphæh in the midst of the words, they carry the ALphæh to both sides of the word to render, Lammæd or Dallath. With the staff in the midst of the 4's, one may balance the equation by doubling the Lammæd, whereby the ratio is 7:7, yielding Dal-lath. The sum total of the three Letters of the Dallath/XℓΔ/4+12+22 = 38, being a reductive of 11, which serves as the primary basis of thought to arise for the Kephúw/Υ. Without the value of 11/ALOZAR, one abides within a static state unable to branch forth the Seed Principle within them. The awakening of the Seed, at the core of one's Name, is coming to the Mind of Unity whereby growth is supported. Until the Seed is ripened to be opened, there is no sprouts occurring, for Wisdom does not support initiations without a dwelling of co-union of sides/Names to secure the emanations of Light.

The double Dallath is the Union of two Teraysarun as occurs in the Name of Daúwid/ ΔΥΔ, which is known henceforth, according to Wisdom, as the Tabernacle of Daúwid/devoted pairs/houses. The double configuration carries the value of 22, 11+11, the expression of Totality which carries the value of 1 = ΥΥΥ/28/10/1.

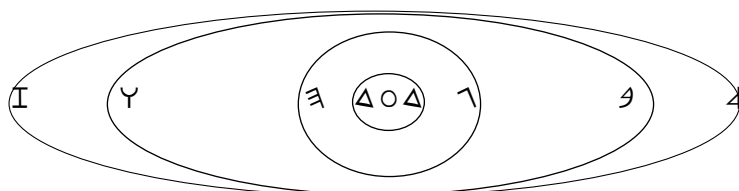

## The Letters—The ALhhim of Understanding

### Four Houses of Understanding—Four Families of the NCH/חא

#### NEÚWN-CHAYIT/אח

5 (5 = 5) 5	9 (4+4+1) (1+8) 9	The Numbers
ח ח ח	— ח ח ח א א	The Letters
5 : 5	+ 9 : 9	The Ratios
		1 : 1 The Ratio of the House

The Neúwn, via the number 14/5 position is the Head of the Ha/5. The Neúwn draws out of its side the Chayit/8. 14 minus 8 =6 which is the value within the double Neúwn. The remaining 6/ח is added to the Chayit/א showing by numbers that the Chayit has come from the midst of the Neúwn which is its origin of 14. The double configuration of the United NEUWN, or its sum value (14/ח +6/ח +14/ח), is the value of 34/16/7, the expression of completeness, from which all 7's or perfection comes. All things are complete as they are paired as the double Neúwn. One-half or side of its reductive value of 16 is 8, the Chayit/א.

#### MÆYIM-TÆYTH/אח

4 (4+1+1+4) 4	10/1 (4+4+1+1) (1+9) 10/1	The Numbers
ח ח ח ח	— ח ח ח ח א א	The Letters
5 : 5	+ 1 : 1	The Ratios
		1 : 1 The Ratio of the House

The Mæyim/ח gives the Tæyth/א—unto an assembly of Heads, even as the waters flow within a plant to bring forth the heads of grain. The Letter Mæyim/ח/13 draws out of its side the Tæyth/א/9 with a remainder of 4. In the midst of the Mæyim, the Yeúwd/ח/10, the value of 4 is retained, whereby the Neúwn/14, from which the Mæyim comes, is in its midst. The evidence of the Yeúwd, being 10 is extended into the Tæyth, being a 10:10 ratio. The value of 4, pertains to the essence of the Mæyim/13/4 and also the Dallath/א and the Taúwah/ח, being the other strands of 4 with the Mæyim. The three fours, reveal the interrelationship of the Mæyim/waters which are transmitted through opened gates/Dallath/א to yield an composition of thought/Taúwah/ח . Through their common value of 4 in the midst of the Mæyim/ח and the Tæyth/א , there are 4 quarters appearing with the Tæyth, even as the figure 8 appears in the Chayit/א . These 4 quadrants or pyramids are two Neún united, each side comprise of two Neúwn or the heads of two serpents, whereby there are four pyramids in one circle. The shape of the Dallath in the top of the Neúwn/ח . Looking from above the shape of the Tæyth, one sees the four Neúwn's assembled from which comes the four faces or the Tsephúwen/north, the Qadam/east, the Negev/south and

the Yam/west. These four faces within the Tæyth, show the Presence of the ALhhim of the Mæyim ever present in the Tæyth as 4 faces + 9 =13/Mæyim.

The sum value of the Mæyim (13/𐌚 +10/𐌗 +13/𐌚 ) is 36/9, which is the Tæyth, through which all union of heads come forth by the flowing waters in their midst. The united Mæyim, 13+13 is the value of 26/HaSham/YæHúwaH. The Yeúwd in the midst is the Hand of YæHúwaH, which being extended, brings forth the double Dallath or the House of The Name. Through the Yeúwd or the hand/giving/doing one comes to the Tæyth level of consciousness. All properties of thought are exchanged through the Mæyim/fluids, whereby the Heads gather, collect, and assemble to behold all spaces, angles, and levels of perspective commonly called the north, east, south and west.

As one beholds the 4, being the reductive value of Mæyim/13/4, within the Tæyth, one can now see how the Taúwah/X is the tail of the Head of the Tæyth/⊕ which is appearing within the mouths of the fish head. How can the Taúwah be the tail of the Tæyth? The Taúwah is the tenth position beneath the Tæyth, residing at the side of the ALphæh as the Letters form one continuous circle of Light. The Tæyth-Taúwah serpent is the second serpent of DAN; the two intertwined provide the scale of justice. As the base of the serpent, the Taúwah composes the heads of grain that come forth from the mouth of the Tæyth. The Taúwah itself is composed of two strands, as two serpents joined from their midst. This foundation gives rise to all Understanding and Knowledge.

According to the Letters being in a circle, there are circle rainbows of the full spectrum of Light. In that each Letter has a shape, the shape pertains to a frequency of thought being emitted and the associated color that it vibrates. In essence, all Letters are a white line or a wave, —, whereby they are organized in # bonds of Light. From this white radiance, all colors burst forth.

### LAMMÆD-YEÚWD/𐌗𐌚

12	(4+4+4=12/3)	12	1	(4+6=1)	1	The Numbers		
Δ	𐌚	𐌚	𐌚	—	Δ	𐌗	𐌗	The Letters
12:12		+	10:10		The Ratios			
Δ	𐌗	𐌚	𐌗	𐌗	𐌗	𐌗	4 : 4	Lammæd, with the ALphæh
							1 : 1	The Ratio of the House

The LAMMÆD-YEÚWD House of ALhhim contains the totality of the 22 Letters which are housed with the Laúwim—the offspring of the LAMMÆD-YEÚWD. The sum value of the Lammæd (12/𐌚 +13/𐌚 +4/Δ ) is 29, which is the full value of the Letters of the Yeúwd/20 extending the Tæyth/9, through which all teachings of Light are brought forth upon the branches of the United Heads. The Letters of the Lammæd and the Yeúwd are the same in number. The Letter Dallath/Δ in the Letter Lammæd and in the Letter Yeúwd is the same 4:4, and the combined values of the Lammæd/Mæyim/25/7 is the same as the combined values of the Yeúwd/Úwah/16/7, 7:7, whereby their Names (4+7) are 11:11, and they have in their midst the Double Kephúw/𐌗—The Tree of Lives. As the Laúwim partake of that which is in their midst/𐌗, they bring forth the Teachings of Life.



In every example of the pairs of Letters, the ALhhim give and receive, whereby they speak according to the mouth of ALOZAR/11, or 1:1.

### KEPHÚW-KEPHÚW/ΥΥ

2 (6+6+8) 2	—	2 (6+6+8) 2	The Numbers
Υ Υ 7 Υ	—	Υ Υ 7 Υ	The Letters
20:20/2:2	+	20:20/2:2	The Ratios
			1 : 1 The Ratio of the House

Within the House of the double Kephúw are all of the Words of Life, which are the sayings of Unity. The double ÚWAH, being 6+6/12, also is housed within the Kephúw from which comes all 30/Instruction/LAMMÆD for every degree of Understanding.

## The Letters—The ALhhim of Knowledge

### Four Houses of Knowledge—Four Families of the Shayin-Semek/ÆW

#### SHAYIN-SEMEK/ÆW

5 (1 1 3) 5	—	(2+4=6) 6	TheNumbers
Υ 4 W	—	Υ 6 Æ	The Letters
5 : 5	+	6 : 6	The Ratios
Υ 4 7 4 Æ			7 : 7 With the ALphæh
			1 : 1 The Ratio of the House

The SHAYIN staff has the base of the HHÚWA. One may discern further the properties by using a method of mathematics called “the Value of Transposition”, whereby the base is divided into the Head. The SHAYIN transposition states that “The Light/Æ of the Sun/W =60.” In this case, that which is within the SHAYIN, as the sun, is divided by the totality of its body, whereby the Value of Transposition is derived. The HHÚWA divided into SHAYIN is the same value of SEMEK, both being 60 according to the extended Number of Knowledge (300/W ÷ 5/Æ =60/Æ). What is within the SHAYIN/W is given to reveal the number of 20/Υ+40/7=60/Æ which are the values of the Letters in the SEMEK/Æ. That which comes from within the SHAYIN, being the SEMEK, is 180° from the SHAYIN, as the base is 180° from the crown. This 180° shift occurs on the 15th day of the month—the day of the SEMEK/Æ. The 15th day of the month, in the first six months of the year are depicted by the right knee cap; and the 15th day of the later six months is the moon of the left knee cap. The full moon is depicted by the buttocks comprised of two halves or sides. As the moon revolves through the camps from the first day of the month, it affects the motion in the manner that we walk. The entire month is 30 days, or a period of instruction, where-

by the body of the month is the LAMMÆD, which as the leg has the value of 30. Each day there is a position for the leg that corresponds to the day. As the moon moves and rotates, likewise do the hips rotate in respect to the position of the moon each day. As the rotation occurs from the hip, the camps are positioned according to their full extension, or their kneeling down, as the leg is either strait-up as on the full moon, or fully bent at the knee as on the 15th of the month.

According to the number of the day in the month so is the rotation of the body and the flexing of the leg. This movement and position of the leg are in accordance with the work of the Lights within the camps each night and day. The legs carry the camps and position them at an angle relative to the location of the moon each day. The reason that the moon is not seen on the 15th day is because the LAMMÆD is kneeling down, and the cap, depicting the small moon, cannot be seen. The bowing of the knee is the position of the tribes, as denoted in the dream of Yúwsphah, when all members bow unto Yúwsphah, whereby a new bed of Principles/Seeds begin to arise within a new state. The leg is straight and up-right on the 1st day. As the moon begins to give out its light, the leg of the moon revolves left to right until it gives all of its light in 15 parts movement. After the 15th, the leg then begins to swing right to left until it becomes strait again on the 30th of the month. From the beginning of the month at full moon, the leg descends until the 15th day, whereby it is folded completely behind the buttocks (full moon) in the kneeling position from which the leg begins to spin right to left to complete the rotation of understanding back to the full moon positioning. This movement of the leg is according to the 1:1 ratio which is the 15:15 or 204060:204060/𐤆𐤍𐤅. The legs are of the moon, whereby the hands are of the sun.

The transposition occurs through the sign of division which shows what is within the Letter. The transposition process takes the base or foundation and divides it into the head. The HHÚWA is both the base of the NEUWN and the SHAYIN, for from HHÚWA comes both Lights to govern day and night. The HHÚWA divided into the NEUWN is 10 or One. The term, transposition, pertains to transferring what is in the base to the crown. Through transpositions, all that is laid within the foundations arises unto the top whereby the SHAYIN glory, radiance, and Fire breaks forth. This process is the Union of ARAL, whereby all that is given to the Mind to be blessed and expanded, returns unto AL the Kuwhænim which speak all things into being. In this manner, The One of the ALhhim formulated the sun from the HHÚWA, which came from the NEUWN.

### RAYISH-OYIN/O4

3	1	2	7	(5+1+1)	7	TheNumbers	
W	𐤆	4	—	𐤆	𐤆	𐤅	The Letters
3	:	3	+	7	:	7	The Ratios
1 : 1 The Ratio of the House							

The transposition of the base or foundation of the OYIN body is the ZAYIN. As we transpose all within the ZAYIN to the OYIN we derive the Value of Transposition, being ONE. The Number ONE is within the ZAYIN whereby the ALPHÆH become given. When the ZAYIN gives the ALPHÆH unto the consciousness of the ALL SEEING EYE, then shall full redemption of our dwellings occur.

Note that RAYISH is the HOUSE of the threes (3:3) and the OYIN the House of the sevens (7:7). Together they comprise the Value of ONE or ALPHÆH; two heads united form the value of 200 which arises from the foundation of the ÚWah/6, whereby the numerical value of six appears in the values of the Rayish: 2+1+3. This union is the full consciousness of AL within the offspring of the ALhhim, of which we are by Name, not by the forms of these mortal dwellings.

The RAYISH is served by the LAMMÆD and the GAMMAL through which all of Light/Hhúwa passes according to a triad or threes, i.e. 30 days in a month. The Rayish/4 is drawn out of the LAMMÆD-ALPHÆH/4 Union, 3 - 1 = 2 which indicates that the State of our Minds is according to the INSTRUCTION/LAMMÆD that we are receiving.

### QUPHÆHH-PAÚWAH/𐤒𐤓

<b>19/1</b>	(5 8 6)	<b>1</b>	<b>8</b>	(5+6+6)	<b>8</b>	The Numbers
𐤒	𐤓	𐤔	—	𐤒	𐤓	The Letters
1	:	1	+	8	:	8
						The Ratios
						1 : 1 The Ratio of the House

The servant of AL is the Quphæhh or the priest which serves the Minds of all Names to know the Principles of LIGHT which are never bound nor limited. This freedom of Mind is within the Priest whereby the Priest is the Liberator or the Saviour of all Names, depicted by the TSÆDDA being within the QUPHÆHH-PAÚWAH ring of Light.

### TSÆDDA-TSÆDDA/𐤔𐤕

<b>5</b>	(1+4)	4	(1 9)	<b>5</b>	<b>5</b>	(1+4)	4	(1 9)	<b>5</b>	TheNumbers
𐤔	Δ	Δ	—	𐤔	Δ	Δ	𐤔	𐤕	𐤕	The Letters
		5	:			5	:			The Ratios
						1 : 1 The Ratio of the House				

### TAÚWAH/X

In each of the United Pairs of Letters there is **the Taúwah/X**, whereby they are joined as two sticks or branches of Life 1:1. The Taúwah Letter includes the ALPHÆH at its side, as the ALPHÆH are in all Letters and may serve to render the balanced ratio as all properties of the Seed Word are in all Letters and Words. The ALPHÆH is the Seed Word of AL from which the Sayings of AL are uttered by the Kuwhænim, which abide within the LAMMÆD-YEÚWD Ring of Light. The ALPHÆH Presence is fully extended in the QUPHAH/𐤒 through YEÚWD, both being Ones, whereby an enlightened priest/𐤒 of AL declares the Unity and 1:1 ratio of pure words.

<b>11</b>	(5+6)	6+1+4	<b>11</b>	The Numbers
𐤒	𐤓	𐤔	X	The Letters
				11:11 or 1:1 The Ratio

## The Houses of Knowledge

W 4 4 1 7 0 3

The Houses of Knowledge, bear Heads of Wisdom and Understanding, to bring forth offices of Light. In these symbols are positions of Light which are the means to govern all states. These seven positions attest to properties in the Seed rising fully within your Name of Light, whereby you are called the Seed/Offspring of Avrehhem. The ALphæh has been magnified and the full spectrum of the Lights are reigning in your houses and lands.

Judge	Counsel	Priest	Redeemer	Prophet	Seer	Alder
W	4	4	1	7	0	3

In some words, a ratio of 1:1 appears as the head and the tail of the word with a common value in its midst. In the Name of the Laúwim, the value of 1 is in the midst. The sound of the ALphæh is present in the Name as instruction is drawn out by Mæyim with the root word, Laúwi/לֹוּי.

4 (1+6+6=4) 4 The Numbers  
 4:4:4 לֹוּי לֹוּי לֹוּי 4 4 The Letters  
 1:1:1 The Ratio

Every word unfolds like a flower, as it is being supplied with the Lights from the sides of the North and South—the two sides of every paired Letter.

### The Three HEADS of the Years and their Lights—Offspring

There are three heads that govern movement of the celestial bodies: the Neúwn, the Zayin, and the Shayin. **These three heads are the head of each house of Thought, and hence, they are the three Heads of the ALhhim.** The Neúwn is the Head of Understanding that is in the midst of all things Neúwn—Chayit; the Zayin is the Head of Wisdom and Her Assembled Letters within Zayin—ALphæh; the Shayin is the Head of Knowledge and all Letters within the Shayin-Semek group. There are 6 Letters within each of the Heads. These Letters are paired within each of the heads whereby the Houses in them are secured and whereby there is no corruption of thought therein. The pairing of the Letters into rings form 7 rings of Light which corresponds to the 7 Rings of ALOZAR.

Each of the Three Primay Heads amongst the Letters carry three primary colors: Blue, Yellow and Red. The Shayin carries the frequency of blue, the Neúwn carries the frequency of yellow, and the Zayin carries the frequency of red. Each primary color has 7 streams whereby the shades and hues of each primay color are drawn out. While one may come to know the Letters by their shapes/characters, **their essence is not bound to any shape as they are streams of Light depicted as a bar — of color.**

Knowledge:	Shayin								Semek
Understanding:	Neúwn								Chayit
Wisdom:	Zayin								ALphæh

These three groups of 7 convey the value of 21/Fire. Each color may blend and intertwine with another, whereby thousands of colors are rendered and whereby there are thousands of shapes that are determined by the combined frequencies of Light. The seven strands of Wisdom blend with the seven strands of Understanding, whereby there are 49 more colors. The seven strands of Understanding blend with the seven strands of Knowledge, whereby there are 49 more colors. The seven strands of Knowledge blend with the seven strands of Wisdom, whereby there are 49 more colors. In each level there are 49 colors unto the 50th—their full liberty of expression within the space to which they are assigned. The 50th occurs as the summation of unions is expressed. Once Values of 49 are attained in each color stream, through perfect unions amongst one another, the colors become transferred into a new state. With the transfer they receive a plus 1 value to convey the Unity which follows thereafter via which they are not bound within their former state. Yauwbell/Jubilee comes by Numbers/values and their colors/vibrancy, whereby the full spectrum in each house is no longer bound, but rather free in that each color has been given itself completely to another in perfect Union. Thus, there is a Yauwbell/Liberty for the Houses of Wisdom, for the Houses of Understanding, and for the Houses of Knowledge.

Freedom achieves a proliferation of thoughts that proceed from the 49th level. Various permutations of numbers convey the potential expressions that are on-going from the Union. Each new color may combine with another until every frequency of light, those seen and unseen, convey the full mind of ALOZAR. There are 3 Primary colors and 21 standard colors. These added to the three sets of 49 yield 171 colors or the reductive value of 9 according to the 9 threads of thought ( $3+21+49+49+49=171/9$ ). The nine threads of thought are colors bands of either three or two strands each as they combine by value/number, i.e. The one's are three strands comprised of the Letters: ALphæh, Yeúwd and Quphah. The nine's are two strands of the Tæyth and Tsædda. The plus 1 to each calculation of 49 occurs as the 49 are regarded to be One House, which is the result that comes by the multiplications in each level. With the plus 1 to each House yields the a value of 174, with the reductive of 12/3, from which all things proceed and to which all things return/belong.

Through permutations of mathematics, the 21 standard colors may multiply to yield literally millions of colors that are not seen by the mortal eye. Even as the stars appear, white, they have colors that are not seen by causal observations. There are deeper and lighter colors that the unopened eye does not see and yet which are carrying thoughts of the ALhhim to us daily. An example of a three Letter permutation is to select any 3 colors of the 21 and blend them with the remaining colors. As you select one of the three, there are 20 remaining, and as you select another Letter, there are 19 remaining. Possible combinations of the these three Letters are determined by multiplying  $21 \times 20 \times 19$  which produce 7980 color combinations.

The Permutations of the 21 colors in 7 rows.  
Each combination is held together by the Taúwah.

colors/frequencies/waves of Light

21 =	21
21 x 20 =	420
21 x 20 x 19 =	7980
21 x 20 x 19 x 18 =	143,640
21 x 20 x 19 x 18 x 17 =	441,883
21 x 20 x 19 x 18 x 17 x 16 =	39,070,080
21 x 20 x 19 x 18 x 17 x 16 x 15 =	586,051,200

Total combinations per side of the Menurahh Branches: 627,715,721

Each side of the 21 Letters form the three branches of the Menurahh. Via permutations, possible combinations of the 21 Letters yield 627,715,721 pairs of thoughts per side of the Menurahh. The reductive value of this Number is 11 or a 1:1 ratio. Through the words of the ALhhim/Gods, the worlds of Light are composed which far exceed the lands that have dammed themselves to destruction.

The English language has approx. 1 million words. Numbers are conveyed by Roman numerals and Arabic numbers. The values of the Oovri/Hebrew are within the Letters of the ALhhim. The Menurahh is comprised of 627,715,721 pairs of light frequencies. The reductive value of this Number is 11 or a 1:1 ratio. Both sides of the Menurahh are the united Kephúw/Υ, expressing the value of 22/X. All of the words of the ALhhim/Gods are creating the worlds in which the forms are invisible, whereby they far exceed the lands and the forms that have dammed themselves to destruction. Being invisible, the ALhhim do not limit their expressions in any manner, nor do they project themselves apart from the total flow of Light [Colossians 1:15]. They are ever circling, according to the Mind of ALOZAR. In knowing the ALhhim, we cannot fix their shape or consider them to be of a form that does not change, for through their Unions in Light, there are no limitations to their expressions, except to those expressions that conform to their solidarity of thought of being 1:1. Though we have Letter forms, they only depict positions and functions of Light and do not represent the ALhhim by form. For when we speak the Letters, they are not seen, being invisible as the ALhhim.

Words are generated night and day according to the arrangement of the camps surrounding the Mishkan. The camps depict the clusters of stars which carry forth the messages of Wisdom and Understanding upon our lips of Knowledge. The words are produced from the Mizbaach Oylah/the Altar of the burnt offering as the ashes are carried unto the sensors of the Mizbaach haQetoret/the Altar of the spices. As the Chalavanah spice is given unto the ashes of the oylah upon the Mizbaach haQetoret, the rods move quickly amongst one another as electrons. As the rods unite, words are formed. The words arise from the heart—out of the ashes of the oylah—within the spices before the mind. The potential number of words through the interacting rods

yield 1,302,061,344, being a 1:5:7:11, in which are the twelve, (302) 5 + (061) 7 = 12, rendered as the perfection/7 of the Lights/5. These 12 are in the midst of the parameter numbers: 1 + (344) 11 = 12. These two sets of 12, the twelve in the midst and the 12 surrounding are the 12 pairs of the ALhhim from which come the 24 Alders.

union of rods/electron combinations within the heart/basis of word formulations  
levels 1-7

12 =	12
12 x 11 =	132
12 x 11 x 10 =	1320
12 x 11 x 10 x 9 =	11,880
12 x 11 x 10 x 9 x 8 =	95,040
12 x 11 x 10 x 9 x 8 x 7 =	665,280
12 x 11 x 10 x 9 x 8 x 7 x 6 =	3,991,680

The colors/frequencies/waves of Light and the union of the rods to yield words have the same reductive values in stages 1-7:

21/12/3 =	3
21/12/3 x 20/11/2 =	6
21/12/3 x 20/11/2 x 19/10/1 =	6
21/12/3 x 20/11/2 x 19/10/1 x 18/9/9 =	54/9
21/12/3 x 20/11/2 x 19/10/1 x 18/9/9 x 17/8/8 =	432/9
21/12/3 x 20/11/2 x 19/10/1 x 18/9/9 x 17/8/8 x 16/7 =	3042/9
21/12/3 x 20/11/2 x 19/10/1 x 18/9/9 x 17/8/8 x 16/7 x 15/6 =	18144/9

The combinations of the 7 colors = 627,715,721/11, the 1:1 ration of ALOZAR; the combinations of the 1-7 steps of word formulation = 4,765,344/33/6, the fruit of Unity. Out of the midst of all Lights seven stars, come forth the complete words to unify all things.

union of rods/electron combinations within the heart/basis of word formulations  
levels 8-12

12 x 11 x 10 x 9 x 8 x 7 x 6 x 5 =	19,958,400
12 x 11 x 10 x 9 x 8 x 7 x 6 x 5 x 4 =	79,833,600
12 x 11 x 10 x 9 x 8 x 7 x 6 x 5 x 4 x 3 =	239,500,800
12 x 11 x 10 x 9 x 8 x 7 x 6 x 5 x 4 x 3 x 2 =	479,001,600
12 x 11 x 10 x 9 x 8 x 7 x 6 x 5 x 4 x 3 x 2 x 1 =	479,001,600

The combinations of the 5 ascending levels = 1,297,296/9 as that which arises upon the words of Unity lead to levels of the upper waters or higher frequencies of Words of Knowledge. Total value of all words generated by the 12 levels of thought, proceeding from the 12 House of the ALhhim are 1,302,061,344/6, the summation of perfect Unity in which are 12 compounds of thought and the full House of Knowledge/9.

The value of Words, 1,302,061,344, reduces to 42, the left parameter Number of the Letters, Zayin/7 + Neúwn/14 + Shayin/21. The Number of its association is 823,059,744, has the reductive value of 24, the right parameter Number of the Letters, Alphæh/1+Chayit/8+Semek/15. The Number of association is derived from the permutations of 1-11, that which is given of the 12. The twelfth permutation is 479,001,600, which conveys the Mind/479/20 of United Pairs/600/6 in which is the Alphæh/1. Together the values form the summation of 27/9 (20+6+1)—the United Faces/⊕, being of the 4 quadrants, from which comes the full spectrum of the lights. Hence, the colors and their waves of 1,255,431,442 are in the midst of the Mind/20/4 of the Unified Sides/6/Υ and appear as the ALphæh/1/4 opens within the mind. Both the 42 and the 24 reduce to 6, whereby the two sides of each Name form a 12 or a teraysarun crystal. As two teraysarun unite there are four sides, whereby a House is built that corresponds to the Number of the 12 pairs of the ALhhim/Letters. Within the parameters of the Letters or Words are the 627,715,721 colors light patterns through which the 1,302,061,344 words become written. The colors appear through what is spoken. The Letters are written through the emanations of the colors. First there is Breath that speaks the words. From what is Breathed the colors appear. Through the colors come forth the writings. The writings are read as they Breathed through formulations of 11, or as words of a 1:1 ratio. First there is Breath or Understanding, then Wisdom, conveyed by the colors, appears to the right side of Breath, and then the Words of Knowledge form from the colors as they are Breathed upon. When one uses words apart from the Breathed colors, they speak as the dead and perform the deeds of the dead, for the Life is not in them.

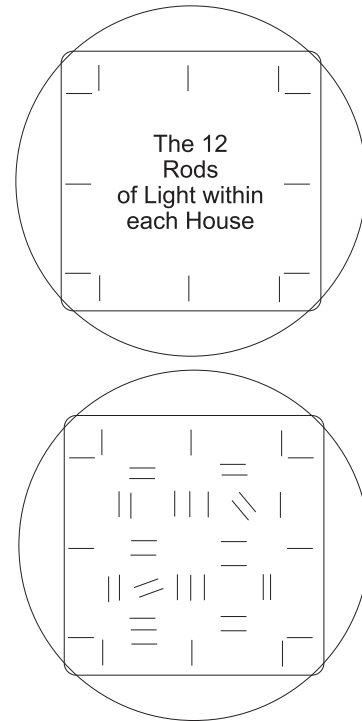

The 12 Rods of Light spark and combine in the midst of the Fire upon haMizbaach haQetoret—the Altar of Incense as the spice of the Chalavnah אֲזָחָה is offered; the rods are joined by the Láuwim in the midst, whereby every Word formed conveys a ratio of Unity.

In that there are two sides to the Letters of 7/completeness, we double the value of 627715721, as the two sides of the menurahh, to arrive of the total emanations of Understanding, which are 1,255,431,442. These abide within the emanations of Wisdom, being 1,302,061,344. The difference between these two number is 46,629,902, being an 11, or those of the 1:1, as ALOZAR and YAHÚWAH are 11. Words that value 11 contain the inward balance and harmony of Light and are to be carried upon the Breath as they are written. What is the within these two Numbers? These are the Láuwim/Levites. The first born of Aharúwan is Yahúdah, for the Láuwim, and the Bridge who draws the wine, are already with Aharúwan.

The values of 1,255,431,442 + 1,302,061,344 = 2,557,492,786 which have a reductive value of 55 or 1, being a .5+5. These two values are the basic thoughts of Understanding and Wisdom, Understanding being the smaller of the two for Bayinah always submits to the Principles of Perfect Unity as Yahuchannan/John the Baptist submits to Yahushúo.



70,000,000,000,000,000,000,000 stars in the universe are detected. Do you see a reference to this Number and the Oyin/Ayin Letter? 70 sextillion stars and counting. The vastness of ALhhim is derived upon a 1:1 ratio of Letters and Words formulation, whereby there is no end to the Kingdom of Light. As we take both of the Numbers above—the values of 1,255,431,442 + 1,302,061,344 to their 10th power, we see the extensions of the thoughts of the ALhhim— $2,557,492,786 \times 10 = 25,574,927,860$ , the ever abounding nature of unified Lights 5+5/אָפּאָ.

Each wave of color yields a shape that carries vibrations of combined Letters into one's fields of receptivity. As your eyes open, they behold these waves and shapes of Lights, whereby the ears hear the frequencies being poured out day and night. As these messages of the Letters are heard and transmitted, the mouth has upon its plate/tongue the Words of Light which are spoken as the Words of the ALhhim in a 1:1 ratio [Tehillah/Psalm 19:2-5].

The Yauwbel/Jubilee of Wisdom occurs annually as one makes their transition at the time of Pesach/Passover. The Yauwbell of Wisdom is within the head of Yahúdah and governed by the ALhhim of the Zayin-ALphæh. The Liberty comes through the House of Raúwaben, whereby the eyes are opened unto new states of habitation.

The Yauwbel/Jubilee of Understanding occurs as one enters into new states of dwelling as that which follows the 40 days of the flood, the 400 years in Metsryim, or the 40 years of moving through the wilderness, better known as stages of Word Development under the leadership of Aparryim/Ephraim, in the Name of Yahushúo/Joshua. The 400 years in Metsryim are by hand of Aparryim in which the Houses of YishARAL receive the grain/Seeds of Light. The 40 years in the wilderness are under the hands of maShayh and Aharúwan with Aparryim, whereby what is sown is reaped. The two ascension of maShayh and Aharúwan in Hebron of 40 days each bring forth the Sayings of YæHúwaH:  $40/\text{מ} + 40/\text{מ} = 80/\text{ז}$ . The first 40 days are the days of Aparryim via which the Seeds or Concepts of the Túwrahh are given and then opened, symbolized by casting the Seeds at the base of the Mountain/Head. The second 40 days are the days of Maneshayh whereby the Understanding of the Concepts are written upon the inner tablets. The Yauwbell of Understanding is within the head of Aparryim. The Yauwbell of Understanding is through the House of Maneshayh and governed by the ALhhim of the Mæyim-Tæyth.

The Yauwbel/Jubilee of Knowledge is the liberty of all houses of thought and under the rod of the Neúwn. The Yauwbell of Knowledge occurs in a 49-50 year cycle and occurs with the transition of the House of Beniyman from one state unto another. In the Yauwbell of Knowledge, the Seed is transferred from one land/state unto another. The Yauwbell of the Age is the transition from mortality to the Lands of our inheritance in Avrehhem. The Yauwbell of Knowledge is through the House of Dan and governed by the ALhhim of the Shayin-Semek. This freedom is the full release of Wisdom, Understanding and Knowledge combined. Together, the Union of the years of Understanding/40 and those of Knowledge/50 are  $90/\text{ז}$ , the sign of the coming of the Redeemer. This sign is associated with Saturn, the 7th house and corresponds to the rise of Ayshshur within our members, whereby the judgements of Dan take up resident into a new state.

Though Knowledge flourishes unto 50, Knowledge comes to an end. However, there is no end of Wisdom and Understanding. Prophecies are fulfilled; tongues/languages cease, and Knowledge comes to an end [I Corinthians 13:8]. New words and new faces appear according to the State of the Body from which they come forth.

In every oylah offering, what is known prior within our branches comes to an end as we give-up our 12 branches of Knowledge into the Fire. The branches are the ends of our thoughts like the flowers are at the ends of the stems upon which they open. The roots and the trunk remain; however, the branches are consumed in the midst of the Fire. Daily the words of Knowledge are extended, and daily they are consumed by the Fire. Whatever words of Knowledge are yielded upon the tongue are consumed by the Breath. Whatever a plant produces is eaten whereby the plant is able to produce more. Whatever fruit we eat is consumed in the stomach of Understanding and it is no more. We are to fulfill the prophecies as they are uttered; we are to eat the words as they come upon the tongues; we are to give up the Knowledge unto the Fire that our Branches may ascend into the full consciousness of the the Lights. For as we give up the Knowledge that is in our branches, the mind is renewed with Knowledge that supercedes our former states of knowing. We are not to hang on to partial stages of knowing, for as complete revelation comes forth, all that was prior is consumed to be within the whole. The perfect alone we cherish.

**Every moon is a work of the Light for your pairs of branches.** The Seeded fruit produced each month comprises Words of Knowledge upon one of the Branches of your Tree of Lives, the branch which is activated, turning green for the month. At the end of the month, the Words, or fruit of that Branch, are gathered together and laid-up on the altar of sacrifice as the final day's offering of the month which is made by the activated Branch. In this final sacrifice, the last portion is offered, which is also the very best fruit of the month. The consummation of this final offering is consumed wholly by Wisdom, the Fire of the SHAYIN, into a new body of Understanding depicted by the full moon. As this new body of Understanding consumes all of the Knowledge/Fruit of the month, it becomes full and begins to run out. The filling and subsequent giving causes the Body of Understanding, depicted as the moon, to sow its Seeds unto a new harvest. In this manner the Rash Chadash/Head of the Month commences as worlds form.

After all upon the Branches of Knowledge have been consumed by the Fire of Breath at the end of a month's cycle, a new year commences. *Until we have eaten of the harvest, we are not readied to enter into a new level of study/year/shana. Likewise, for an era. Upon having eaten all of the Knowledge within these vessels we pass into subsequent forms of Light.* Words of Knowledge are sweet unto our mouths if they are agreeable or paired thoughts, otherwise they are bitter coming from a root of poison. As words of the Knowledge of YæHúwaH are eaten, we build-up the Oyin-Zayin Serpent Body of our Collective Names according to the Union of the HhúwaÚwahHhúwa/ אַיָא—the paired Lights of Chækúwmah and Bayinah, in which Union there is no end.

The Branches of Knowledge depict the twelve fruit upon the Tree of Lives. Each of these fruit are a level of expression according to the Trees of Wisdom and Understanding.

Expressions of today give way to new branches or Knowledge that are budding from our loins arising into our Heads. The twelve houses of Knowledge are transformed into wings which serve to carry forward the serpent of Understanding and Wisdom. In the Garden there will be no longer a Tree of the Knowledge of Good and Association, for the former passes away. Only the Tree of Lives, comprised of Wisdom and Understanding remain, and upon its branches The Knowledge of Perfect Associated Names appear according to the State of Their Unified Body. Thereby the Tree that once was apart from Wisdom and Understanding is no more. Herein lies the redemption of all Names, for the fruit upon the branches of Knowledge that abode apart from the Tree of Lives are never eaten again apart from the Tree of Lives. As it is stated, no one eats of the fruit of Knowledge apart from Wisdom and Understanding and lives. Whenever the eyes see apart from Wisdom and Understanding they are subject to death as are all of the members that operate apart from the Body of Light, in which state they enter into mortality, beyond the Rings of the Perfect/7. *No one uses their members apart from Wisdom and Understanding that abide within the 7 Rings of Light.* **The three Houses of Understanding, Wisdom and Knowledge are One Tree, and there is no division in their midst.**

The use of the branches of one's Name apart from their foundation is how the branches of YishARAL/Israel become cut-off from the loins of Avrehhem. This theme is played out in various narratives. When one third of the Names began to eat Knowledge apart from the Priesthood, they ate the fruit or expressions of thought apart from Teachings of Light. One-third began to be in error as those in the upper branches, the upper third, began to exalt themselves. The other two-thirds—those of Wisdom and Understanding do not follow in the same path of destruction. As the one-third partook of this level of thinking they became cut off, as the blind, from the House of AL. What they ate made them blind, as Shimshun/Samson became blind, by partaking of those in the company of Knowledge without understanding and Wisdom. Likewise did the men of Sodom become blind. They ate of the fruit and yet their eyes of Understanding were not opened. They became in opposition, or to be adverse, to the Teachings of Aharúwan. In so becoming, they became born within a different space according to the seed that was in the fruit that they ate. What is born of this world is born of satan which is in adversity to the Word of Aharúwan/Aaron.

The Knowledge of this world is the foundation of mortality. The Knowledge is depicted in the founding of the city of Babylon, whereby the elements of the world are organized by the seeds of diversion. This lack of cohesion is depicted in the statue described in the writings of DaniAL/Daniel. The Roman Empire is the last of the powers of mortality, which has spread out over all the earth by the legs and the toes which carry the messages of the Head of Babylon throughout the lands. The powers of mortality come in waves as kingdom. The first wave or the beginning of this kingdom is in Babel, described in the writings of Sepher Maoshah Bereshith/Gen 11. The head of the statue is of gold, the breast and arms are of silver, and the belly is of bronze; the legs are of iron and the feet of iron and clay. The head of is gold; but the head of the Body of Mashiyach/Messiah is of bronze. In Babylon, gold depicts the gold of this world—the wisdom to which the thought of this world binds them to in this realm. The fall of Babylon has transpired already in the Mind of ALOZAR/Eleazar and in the Minds of Aharúwan/Aaron, though the feet of the statue are still upholding the image until it is cast down within all peoples in which the image resides.

**The statue that DaniAl/Daniel sees falling is the image of mortality.** One enters into this state as they come into the house of Metsryim/Egypt. Pharaoh, depicting the carnal mind that does not know Yúwsphah/Joseph, orders all of the Seed—formulations of Breath/offspring to be cast into the river. The command to cast the Seed into the River is accepted and continually followed by the minds of this world, whereby the formulations of the Breath of the Oovri/Hebrews are kept within the body of Pharaoh; however, the Oovri/Hebrew midwives do not agree. The river of Egypt is the vagina from which a river of blood flows, whereby the Seed enters into the dungeons of mortality. The seed cast into the river remains under the hand/direction of the Pharaoh, for the extent of its flow is held within the framework to which it is cast. In that the carnal mind does not know Yúwsphah/Joseph, Pharaoh keeps the Houses of YishARAL/Israel in captivity, for when one knows Yúwsphah/Joseph, they know the path of expansion and freedom. The type of body that Yúwsphah creates is not known to the carnal mind, whereby it accepts a dwelling as a slave, within a world of corruptible flesh.

The image that DaniAL/Daniel sees is the body of Babylon. The bodies of Pharaoh and the statue of Babylon is one house of Cham/Ham. The image is the mortal body. The stone that crushes this body is from the upper left side of the Mind of Aharúwan/Aaron, from whence it has risen to fall and smash asunder the toes of the statue so that the image falls head long. This stone will fall out of the mountain of every Name, whereby the feet that is upholding the statue will be stricken. The entering into the mortal woman is bowing down to the image.

As in the story of Shimshun/Samson, the image falls by the dedicated mind as it awakens and pushes the legs of the house apart so that it falls and crumbles with all that is within it. The story of Shimshun/Samson and the story of statue in the vision of DaniAl/Daniel are the same.

The Letters, at large or in a group, rotating left to right. They move from the North—their home plate, to the East, to the South, then to the West, and back home to the North. The rotation of each Letter is according to their orbit or place within the consortium of the Lights. Their orbits are set so that the Letters interact with one another. As each Letter comes into proximity with another, they convey messages through word formations. While the Letters are moving left to right, there is a current within them that moves right to left. This current of thought is for growth stimulation, expansion, and to resound the vibrations of Light. Those moving in retrograde motion are the Houses of the Mæyim/Mem—Tæyth/Tet and the Úwah/Vav—Bayit/Bet. These two houses correspond to the planets of Uranus and Venus respectively. This inner retrograde current runs within the parameters of the body that brings the camps to abide together in one accord. The harmony of the running river is the unity of the Houses of the Mæyim-Tæyth and the Úwah-Bayit. The offspring of these Houses of ALhhim are Yúwsphah/Joseph and Shamoúnn/Simeon respectively. In the Túwrahh/Law, Shamoúnn/Simeon is joined with Yúwsphah/Joseph in Metsryim/Egypt until all of the tribes come together. From this account, we learn that as we bind Shamoúnn/Simeon unto Yúwsphah/Joseph we cause a shift or movement within all of the camps. Shamoúnn/Simeon depicts the House of Hearing with the Head of Expansion via which the body expands and provides a space for the other members to come into it. As the current of Shamoúnn/Simeon is bound to Yúwsphah/Joseph, that which is House of Yúwsphah/Joseph flows within Shamoúnn/Simeon, whereby Wisdom and Understanding

create a new state for all of YishARAL/Israel to move into. As a result, the whole house comes into the land of Goshen—into a dwelling according to the Reúwach/Breath of Understanding.

The **Neúwn—Zayin—Shayin** are the heads of each column as the Letters move within their orbits. According to the movement of the Letters, the courses of thought are set within our consciousness. The Neúwn, having the value of 50, makes one revolution every 50 years. According to the rotation of the Neúwn, there is the announcement of the Year of Yauwbell/Jubilee on the ninth day of the seventh month, as the commencement of Yum Kippur. The Year of Yauwbell is announced in the seventh month as the fulfillment of the Shayh that is accepted upon the tenth day of the first month. Thus the Neúwn is a 50 year cycle. One year of Neúwn is 50 year. The Neúwn moves in 12 and a half years per side.

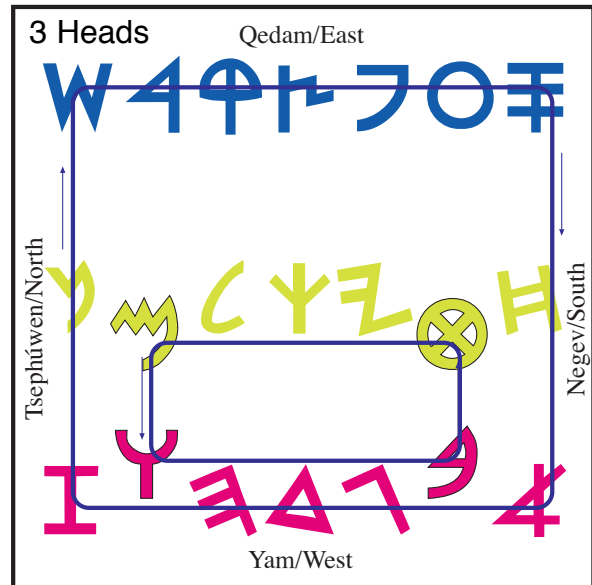

The above arrangement of the Letters are with the 3 Heads of the 3 Houses: The Neúwn, Zayin and Shayin, facing north. As they rotate, they lead the houses to the east, then the south, the west, until they return home to the north.

*Where is the Neúwn* now? According to ones awakening and implementation of obedience, the Neúwn leads the Letters or revolve within your sides. How much of your inner resources have been drawn out and given unto the collective Name of YæHúwaH? When you have given all within you and brought it to the crown of Enlightenment, you have freed yourself from where you were residing formerly. As the grain rises to the heads of the stalks, the plant can no longer hold them suspended. As the grains are carried by the Winds of Breath/Reúwach, the jubilee of Knowledge takes place. This burst of Knowledge is the alignment of all of the Letters together, whereby there is total freedom—Yauwbell.

As the Neúwn leads the Letters into a vertical, 3 column arrangement, the Neúwn is into the Qadam/east. In the Qadam the Neúwn begins to empty into the neck of the Gammal; whereas in the North, the Neúwn spoke through the heart. As the Neúwn moves into the east, the oylah sacrifice commences. The movement of the Letters around the parameter of the Tent of Meeting correspond to the activities within the Mishkan. As the Neúwn arises in the east, the head of the fish appears and formulates four Faces of full expression. See above regarding the Union of the Mæyim-Tæyth ratio of 1:1. As the Neúwn moves the Letters into a vertical column, the Mæyim begins to flow at the neck. As the Mæyim flows a crystal clear river of glass comes forth. When one beholds and steps into this flowing river, they become transparent. In the Heads of the Letters in the qedem lead one to comprehend the origin all things.

As the Neúwn moves into the south, the heads go head-long as the heads become joined to the base. In this position, the Letters are able to arise in the South from their bowing low posi-

tion. In the south, the full revelation of what has opened in the north is made known. The mysteries that open upon each Rosh Chodesh are unfolded during the 12.5 years of southern occupancy. The descent in the south enables one to arise unto new heights and for the branches of a Name to bloom and become filled with fruit.

As the three Heads lead the Letters to the Yam/west, they enter into new horizons that lead to a transfer of residence. In the west the Heads exchange the body of their garments like a snake changing their skins.

In the Tsephúwen/north, the Heads lead to the camps to look inward whereby they govern over all forms and lands by the Mind of the Judge. The coming into the Tsephúwen, is the return of the Queen Bayinah to the Throne in Nephethli (Nepethli). The term, Queen, refers to the full Counsel of ALOZAR, that take its seat upon the Silver Chair. Hence, the term, Counsel will replace the words of King and Queen in subsequent documents. The above movement of the Neúwn is considered to be the Year of the Neúwn.

The Year of the Mæyim moves within the block of Letters, but in retrograde motion to convey the position of Wisdom that is within Understanding and from which all united states of Mind are established. Until the Mæyim moves within your camps in retrograde motion, there is no disturbance of thought within you to bring about a gathering of your camps under One Name. Until that time, your house is divided, and your sides are left open for exploitation and thievery of the riches given to your Name.

The Year of the Zayin is One. During the course of the Zayin, there are four quarters of observation whereby there are four seasons in a year. The Zayin abides 3 months on each side during a year. The force of the ALphæh within the Zayin determines the seasons of a year. In that there is fire in the forest or a freeze over the lands, the ALphæh is not overthrown but will persist within the land in which it is sown until it rises to crown its body with the Light of the Shayh within the 7 Rings. The revolution of the Zayin provides the eyes to behold all things from all perspectives. Accordingly, the eye is a 360° eyeball for it is shaped by the frequency of the color stream of Light pertaining to the House of Raúwaben.

The Year of the Mæyim is 40 year. The Nature of the Light stream of the Mæyim runs long, whereby there are rivers in the land. Though the Túwrah speaks of 40 Year, it is rendered as a combined event and is not counted as individual years. How quickly the Letters move within your Tent of Meeting is not according to the years of this earth that is yielding to a greater body of Light. See BHM Túwrah Dictionary to distinguish between years and year.

The Mæyim-Tæyth union moves as an inner stream counter clockwise as the planets move counter clockwise around the sun. Moving with the Mæyim-Tæyth is the House of the Úwah-Bayit. The other Letters are moving clockwise according to the direction of the Counsel of Understanding. As the wind/Reúwach of Bayinah blows, the Breath pushes the Mæyim right to left, whereby the Neúwn itself continues with all of the other Letters in a left to right rotation.

The year of the Mæyim is 40 Year. The Mæyim resides upon each side for 10 years. The four tens are fulfilled as the inner current passes through the ALphæh to the Yeúwd, the Hhúwa to the Neúwn, the Zayin to the Oyin, and the Lammæd to the Shayin. The inner current within each of these sides causes growth and full extension of thought even as water supplied to the plants within a garden enable them to attain to their full height. As the Mæyim enters into the Lammæd-Shayin level of thought, the thrust of the waters kicks into 50, whereby the Shayin is joined to the base of the Neúwn, that is, the Ha, and thereby brings forth the Light of the Shayh/אָו. This union of Letters is what is known as the full Shayin, whereby the Light of the Shayh burst forth with such radiance that there is no need for the sun or the moon [Chazon/Revelation 21:23].

The year of the Mæyim is 40 as it completes its cycle through the eight united heads denoted above and earlier in this study. The completion of the Mæyim cycle gives a wave of energy to the Neúwn to complete its full cycle of 50 into the Shayin level of Knowledge. The 40 year of Understanding are within the 50 Year of Knowledge. The base of the Shayin is the Hhúwa/Ha/א, as Shayin is the greater or the nurturing Light that comes forth from within the Cardinals of the Hhúwa which is comprised of a total of 10 parts. These ten parts are then distinguished, 5 for the sun and 5 for the moon as two Lights being 1;1. As one divides the crown of 300/Shayin by the base of 5/Ha, the value is 60 which appears in the sign of the Semek. See above the Shayin-Semek union of 1:1 ratio. In that the 10 years of the Mæyim are counted into the Lammæd-Shayin state to fulfill its cycle of 40 Year, the 10 year is subtracted from the 60 whereby the value of 50 Year is accounted unto the Neúwn. In subtracting the ten years from 60, the ten years are not counted twice, but are already within the cycle of the Neúwn, whereby the cycle of the Neúwn is completed during the same Year as the Mæyim. In this method of reckoning, the fulfillment of the 40 year in the wilderness and the release of the inhabitants unto their Land of inheritance occurs simultaneously.

The method of calculating the Year of Yaúwbel/Jubilee is according to the pattern of determining Shebuoúwt/Shavuot. In counting Shavuot/Pentecost, one counts 7 *shavbethuth* plus the following day unto the fiftieth day. In determining the Year of Yaúwbel, one counts 7 months plus one week unto the following day, which is the ninth day at evening, preparing to enter into the tenth day of Aparryim upon which the shofar is blown. The sound is blown within all of the lands during the 7th House of the Tsædda—the House of the Redeemer, corresponding to Saturn, within the 7th month of Aparryim. The count commences from the vernal equinox in the year when the Light sign of Yaúwbel appears. When the full verification of Aparryim comes it is 7 x 7 or 49 year in which Liberty is announced.

### The Ladder of Yaoquv (Jacob)

The Ladder, upon which messengers/messages appear unto the consecrated Mind of Yaoquv, is the Zayin in the midst of the Oyin. The Zayin is the tongue instrument at the base of the Neúwn which serves the Neúwn every way the Neúwn turns, whereby Properties of Wisdom and Understanding pass into and through Oyin unto Rayish—the Mind. Your messages are seated to flower and appear in their glories into the Mind of Lammæd-Yeúwd—those of the

Kuwhænim from whence Properties are sent forth. The Ladder of Yaoquv is the means of expansion of the Neúwn through the Chayit. Via the ladder, Thoughts of AL rise into the consciousness of your ALhhim, whereby Thoughts of AL rise from within your midst of the Oyin-Zayin of ALOZAR. The process of giving the Light is via the Hand of Aharúwan which is in the midst of AL.

The distance from Zayin to Oyin is the space amidst the head/16/7 and the tail/7; by their Numbers of 7:7 they are unified. The space is fully extended in the beginning and in the ending of a rotation cycle as the Head and Tail join, becoming layered upon one another as two ends uniting, as one. In the midst of a rotation or cycle of passing what commences comes to its origin as full moon to full moon. The expansion and the contraction of space between the two ends of your Light Body are means of creating and filling your spaces with all of the Properties of Light in your Seedname. As all things commence in the midst, Zayin and Oyin are together from the beginning. Through they expand to form space in their midst, they hold all things together as One Consciousness. The Light Body of the Zayin—Oyin is the House of Immortality and the Tabernacle Pattern in the Mountain of YæHúwaH. All other forms of habitation are forsaken in order to abide within this Union of the Lights. From these two ends of the Light Body come two Lights, the Sun as the Tail and the Moon as the Head, and all that is birthed from the midst of this Unified Body. *In the midst of this body is the consciousness of the Union of AL and AR. Out of this Union come all ALhhim and emanations of the Light of the Shayh.* Every Head and every Union of the Branches follow this Order of congruency and devotion. Apart from this Order there is no Light and no Life. What is outside the prevailing consciousness of AL and AR is referred to as sons of darkness and a state of sleeping.

When two Names are together, they abide side by side as two circles that form the breast. The breast is their resting place. When the two Names are in the expanding mode, they are still side by side; however, wherever they go, they form the spaces of the head and the round basin of the bottom as the parameters of their thrones. *However, as the two move together, they hallow out by their hand—their activity of Lights. The cavities that are hallowed out remain as a testimony of their works, forever positioned by the bonds of devotion to each other.* Though they move from one end to the other and convene in the midst of Amuwri—the breast, their consciousness and Breath are retained in the places that they have selected, and in these spaces, which are hollowed out, there abides the Lights that do not fail, the these Lights are the deposits, being the offspring of their perfect Union. The collective spaces are called the Body of the paired Lights, aka as the Body of the Mashiyach/Messiah, which is the eternal abode of all Names and the pattern of the immortal Body that does not fade nor fail.

When the Two are in the North of the East, they form the hollows of the eyes, and the Lights within the pairs of these eyes do not go out, for they have within them the Lights of the Menurahh that burns without ceasing. When the Two are in the South of the West, they form

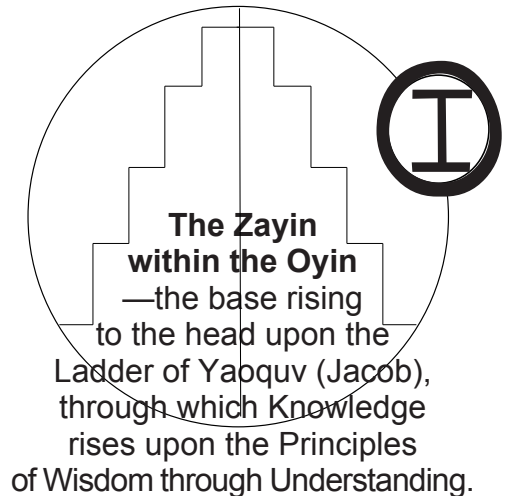



the hollow of the testes, and they bear witness of the work of the Lights to gather all Properties of the Lights for transference. To transfer from one state to another is the work of Fire or consumption. Look at a candle as it burns. The Fire transfers the form of the candle unto another state, whereby what was once there is invisible. When the Two are in the Midst of the Camps, they lodge within the Breast from which we suck to draw out the Thoughts of Wisdom and Understanding through which all camps are nurtured by the Presence of the Lights. What is in the midst is the Land of the Amuwri, from which comes all Words, via which the spaces and the centres of the Light are formed. Through the construct of the Words, the Lights are established and preserved as the House of the Names of the ALhhim, for any construct of pure Light, being of the pure language, does not corrupt. The words are formed as the rods of Light, as light electrons, move within the midst of the consciousness and form Words of a 1:1 ratio as the Rods from all of the House of ALhhim are moving and joining. Some words form as a head and a body, whereby the ratio is i.e. 1:3:3; some words form as two sides, 1:1; some words form as two ends and in their midst a common center: i.e. 1:4:1.

The circle of AL is the means for all thoughts to be glorified, whereby the radiance of the Reúwach/Breath flourishes and resides within a commonwealth of Names. The circle of AL is doubled, as each Letter of ALhhim is doubled, to convey the depth of the thought and its thought. The width and the breadth of the thought of AL are contained within the circle and expands or contracts according to the season or activity of the Lights.

From East, the Light arises, via Chækúwmah, unto the Neúwn (noon) of the day, and then the Light descends. Following the rotation of the Lights in the day, the work is affirmed in the evening via meditation. The circle is then approached from the other side of the ladder, upon which Bayinah ascends and descends each evening as the moon. The ascent of the moon sets a grove into the Houses for the activities of the following day, whereby the Light of the sun fills in the grove and causes an appearance of the thought that is set in the midst of the night. As we proceed from side to side, there is the continually ascension through Bayinah and Chækúwmah with the Neúwn forever in the midst, as the Neúwn is positioned in the midst of the Letters (see following diagram). This perpetual motion is the oylah offering of YæHúwaH that never ceases, whereby the Fires upon the altar are never extinguished.

The Ladder of Yaoquv/Jacob is in the midst of the Lands. The ladder is the Zayin that abides in the circle of the Oyin. Together, the Zayin/I and the Oyin/O form the body of Light for ARAL, which is in the midst of the Name of ALOZAR/ 4TIOÇ4. The sum of the Cardinal Parts of the OyinZayin Body are 230, conveying the Mind of the Lammæd/Ç4. The reductive value of the 230

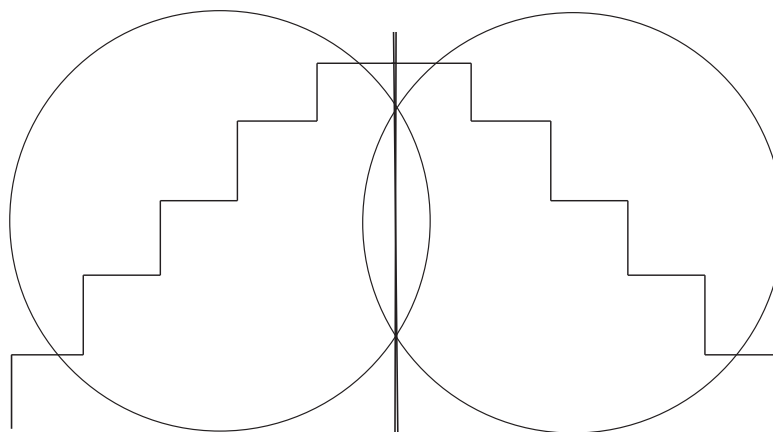

The Ladder of Yaoquv (Jacob), upon which the thoughts, as messengers of Light (angels), ascend and descend.

parts is 5/א, the Number of the Lights. The ZayinOyin Body is the Lamp of ARAL in which is the Light that fills the Temple. As the Words are spoken through the necks of ARAL and opened by the Zayin, the Light of the Words fills the Oyin dwelling that encompasses and surrounds all within the paired Names.

With this configuration of HhaALhhim, the ten Lands of the OyinZayin Body become filled with the Presence and Illumination of ALOZAR.

What occurs within the Name of ARAL is according to the United Principles of AL and AR. The two breasts, conveying the circles of Light, are the fruit of ARAL through which all things are formed in the worlds of Light. The two circles in the chest are the fruit of Bayinah and Chækúwmah from which goes forth the Lights within all of the Lands. In that the Presence of Bayinah and Chækúwmah are in the Lands, the states of the Body are governed over by the Counsel of the Queens: Bayinah and Chækúwmah, the King of AR and the Priest of AL. The central governing rod forms a collective Counsel called YæHúwaH, whereby comes the statement that “YæHúwaH is King in YishARAL.” Though AL and AR are at opposite ends of the Rod, the Zayin is always in the midst of the Oyin, as AL is always in the midst of AR. As with the sun and moon, the rod between them is longer or shorter depending upon the position of the rotation. The Rod that connects AR to AL is the Lammæd, which is called the Rod of Aharúwan/Aaron, being the Rod of the Lights. The rotation of the Lights comprises one day, one week, one month, and one year, for every movement of the Lights are within the all encompassing Rings of ALOZAR. The daily, weekly, and monthly rotations of the moon and sun are composing the larger circle of a year. The years accumulate together to form the orbits of the greater Lights and the spaces called universes. Each universe is called according to a year or a formulation of study. Thus for every part of the Teuwrah Each circle of thought expands as Breath goes forth each day and returns to its den each evening.

#### DAYS IN THE LIGHTS OF OYIN AND SHAYIN

According to the passage of the Lights within the Zayin to the Oyin, there is a measurement of activity. **Each complete activity of Light is called a day.** When Bayinah and Chækúwmah pass amidst the paired two camps each evening and morning, there is a day. An act of Light is a day which is comprised of both Understanding and Wisdom. *As Offspring of the Day, we do the commandments—the acts of Light with Understanding and by knowing how each deed is the fulfillment of the Words of AL that are to be performed within the collective arrangement of Names.* For if we perform an act without the Wisdom of how all things are united, or without Understanding the intent from which the commandment is given, we have yet to perform the commandment as the Offspring of AL. In keeping the commandments to AL, we are not alone, as individuals, for all is performed within the collective body of associated Names, whereby we affirm to be awake and conscious of the Faces of YæHúwaH unto whom the daily oylah is made and unto whom the commandments—orders of the Aharuwan/Aaron are performed.

Complete days are 7:7 as Names of AR and AL, and as 7 Ways of Wisdom and 7 Paths of Understanding, are 7:7. In accordance with the Unified Names of ARAL there is a day, and there

is a progression within a day. Only by being 7:7 have we actually lived a day and performed a commandment. For until we are 7:7, we walk in darkness, whereby the days of YæHúwaH are yet to appear. Furthermore, as we are 7:7, we construct the mishkan and thereby lay in place, as one creates a space and then fills it, the progressions unto the arrunn/ark in which is the Lammæd/Staff of Aharúwan.

When Bayinah and Chækúwmah pass in the midst of four Houses within a week there follows a shavbeth, for having the foundation of four laid, one may come to rest upon the platform made each week. Each shavbeth completes a side or a quarter of the House for the month. Through the four *shavbethuth* of the month, the four walls of the House are built-up on every side, and the work of building a house is completed according to the Lammæd—30 days.

When the Two pass in the midst of twelve Houses for the sake of Two rods, there is a month. Within a month, the moon commences in one rod and ends the month in the same rod. This is called one complete rotation within the rod of the month, for all twelve components of thought are within each rod, although their frequency within a rod is not the same length as the rod that they are within. The Two pass from the head of the month unto the tail of the month within the same rods. When the Two complete the work of Light within each of the twelve rods, which are the twelve houses, there is a year. During the year, the Two will work from both ends of a rod whereby the work is complete from one end unto the other.

According to the extent of the passage of the Lights throughout the camps, there is one day, one week, one month, and one year. When the passage of Two is complete within the camps, there is a sabbatical year. When Wisdom and Understanding complete seven years within seven Houses, there are 49 years, and Yaúwbel/Liberty follows. Yaúwbel is the complete working of the Light in the midst of 7, whereby one arises into a new state or new mind of consciousness. According to the frequency of the Lights within the rods, so are the States or Lands of the rods.

### The Path of Wisdom into the House of Understanding

*Note intersecting lines in the 8:8 Movements of the Lights connects Rings of ALHHIM: e.g. Paúwah to Quphah; Semek to Shayin, Rayish to Oyin, etc.*

Chækúwmah must pass through the Light Bodies of the Zayin to the Mæyim as Wisdom, the inherent Principles within Understanding, arise into the Houses of Understanding. Bayinah must pass through the Semek to the Shayin as Understanding rises in to the Houses of Knowledge. Until Understanding rises into Knowledge, the knowledge is pseudo, being without service and devotion according to the pure Light of Bayinah. As Bayinah moves into the realms of Knowledge, the mind that was once mixed is purified by the Presence of Silver, and where there was confusion now resides clarity. As with the Queen bee, the Counsel of the Lights, Chækúwmah and Bayinah pass through the hive that is composed concentric circles. Everything within the hive is of Shucham, for all have come from eggs of the queen that are without partiality, for each egg may be transformed into a drone or worker or queen according to the well being of the hive. To know our origin in ALOZAR is to know the mind of Shucham, the Name unto whom this document is prepared that it may be the Judge of Wisdom within us.

Chækúwmah must rise from 7 to 40, from Zayin to Mæyim, whereby a change of residence occurs. That is to say, Chækúwmah rises upon the foundation of 7, the position of completeness and upon the stability of the Cardinal Numbers, whereby the Houses of Understanding are blessed, being expanded, with the presence of Chækúwmah. Though the rising of Chækúwmah,

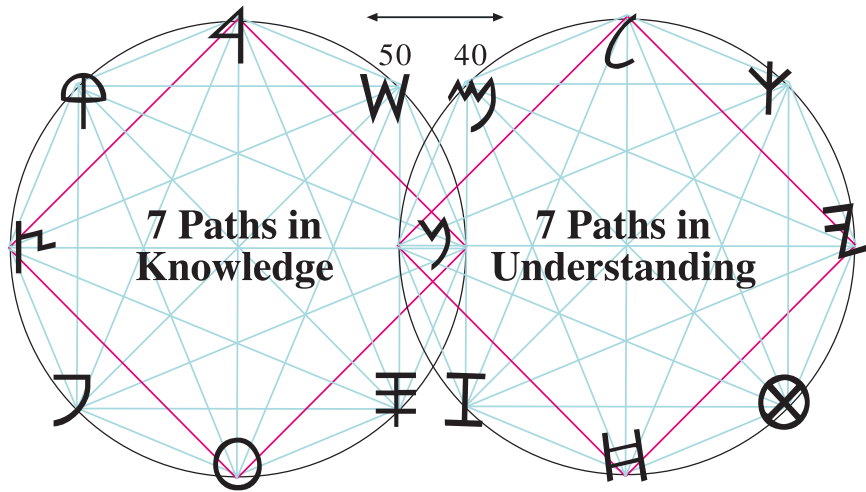

all children are born in 40 weeks, the Names of maShayh and Aharúwan arise in to the Mountain of the Chevroni (Hebron) in 40 days, the Houses of YishARAL pass through the Bemidbar (wilderness) in 40 year, and the Names of Light burst from their dwellings in Metsryim (Egypt) of 400 year (40x10) or the extension of the Hand amidst the waters of Cham. All of the account pertain to the same work of Chækúwmah rising into the consciousness or into the OYIN by the serpent tongue of the ZAYIN.

**The 8:8 movements of the Lights,** whereby the full consciousness of OYIN 8+8=16/O is present unto Liberty/Yuval. Each set of passageways number 49 paths within the Houses of Understanding and 49 paths within the Houses of Knowledge as the Light travels from one Name of ALhhim unto the other.

One path pertains to one year/study, whereby there are 49 years unto Yuval. The movement within the two bodies of Understanding and Knowledge are synonymous.

The 7 Letters depict 7 Names of ALhhim, which when joined with another comprise a house. The 14 Names of ALhhim become aligned with the NUN from which they emanate, and in so becoming, they are at Liberty to move with the NUN into another level of Light.

In the diagram of the 49 Passageways of Chækúwmah, all things proceed from the Neúwn. The Neúwn gives of itself to establish the 4 Primary Letters, which are the

base of Understanding. These four Letters are the base of the Tsur/the Rock. The Neúwn gives the Mæyim (path no. 1), through the Mæyim to the Lammæd (path no. 2), and then to the Kephúw (path no. 3). From this base, the Neúwn extends to the Chayit (path no. 4), whereby a firmament is made for expansion of all that is within the House of Understanding. This extension of the Neúwn to the Chayit is like the space that spreads from the skull to the tailbone. From the skull to the tail bone Chan/grace/𐤇𐤁 abides upon you, whereby all that is within you is favored unto its full expression in freedom. The Mæyim extends to the Tæyth (path no. 5); the Lammæd to the Yeúwd (path no. 6), and the Kephúw multiplies itself unto the Neúwn (path no. 7). Upon building the House of Understanding, the Neúwn extends itself to the Zayin (path no. 8). As the Neúwn proceeds to run with the Letters, a grove or path is cut out within the fields of mind. This space is to be filled with the Light of Chækúwmah. The moon, as the body

of Understanding, makes a path into consciousness; the sun nurtures and fills the spaces with the Light of Wisdom. Through the Zayin, Chækúwmah is able to trace every path that Bayinah has made. As Chækúwmah rises in the Zayin, the Zayin affirms itself to every position in Understanding via the (paths no. 9-14). Rising through the Zayin, Chækúwmah runs the complete course through the paths in which Bayinah has laid.

The Chayit, being positioned by the Neúwn (path no. 4), then affirms itself to the four Letters (paths no. 15-18) of the Zayin, Mæyim, Lammæd, and Yeúwd, and then bonds this base to the Tæyth (path no. 19). The Tæyth, being positioned by the Mæyim (path no. 5), then affirms itself to the Letters to the Zayin, Neúwn, Lammæd, and Kephúw and then bonds this base to the Yeúwd (paths no. 20-24). The Tæyth rises to kiss the Neúwn as a grandchild rises upon the lap of its Grandparent (path no. 21). Each Letter touches (agrees with) the base of their body, being the Zayin, whereby they know their foundation and origin in Wisdom (paths no. 8, 14, 20, 26, 32, 37, 43). The Yeúwd affirms itself to the Letters (paths no. 25-29) of the Chayit, Zayin, Neúwn and Mæyim and then bonds this set to the Kephúw, whereby every deed is according to the Principles of Chækúwmah and the Illumination of Bayinah. In affirming every move of the hand, the works are done in the Light of Chækúwmah, whereby there is no sin or violation ever committed. The Kephúw affirms its position to the Tæyth, Chayit, Zayin, and Mæyim (paths no. 30-33), whereby the Tree of Lives bears the fruit of the four sides/seasons, as a tree planted in the House of Yúwsphah/Joseph (Mæyim-Tæyth), to which the Zayin is dedicated to bring forth the ripened seed within the fruit of Aparryim. The Kephúw is bonded to the Lammæd by the initiation of the Lammæd (path no. 3), which affirms its role to convey Wisdom into the foundation of the Yeúwd, its right hand, and to the Tæyth, Chayit, and Zayin (paths no. 34-37), and then forms the two sides of the Master square within the House of Understanding via the paths of the Yeúwd and the Neúwn (paths no. 34, 38). The Mæyim affirms its delegation to water the Tree of Lives (path no. 39) and to bow to its foundation in the Yeúwd, Tæyth, Chayit and Zayin (paths no. 40-43), for from these Letters, the waters flow by the hand/Yeúwd that manages the rod, and are gathered within the Tæyth basin to provide the washings of the Chayit and the flow of the Zayin unto renewal. The Neúwn, which initiates the movements, then completes all that it commences from the beginning, as it lays the path of Chækúwmah to acknowledge the Lammæd and then to bow to the Kephúw, the Yeúwd, the Tæyth, and the Chayit, which are the faithful servants of the court of Bayinah, having already established forever its direct flow of information to the Mæyim and Zayin. For according to the works of the Kephúw—the Tree, the Yeúwd—the deeds, the Tæyth—the associations of being paired and

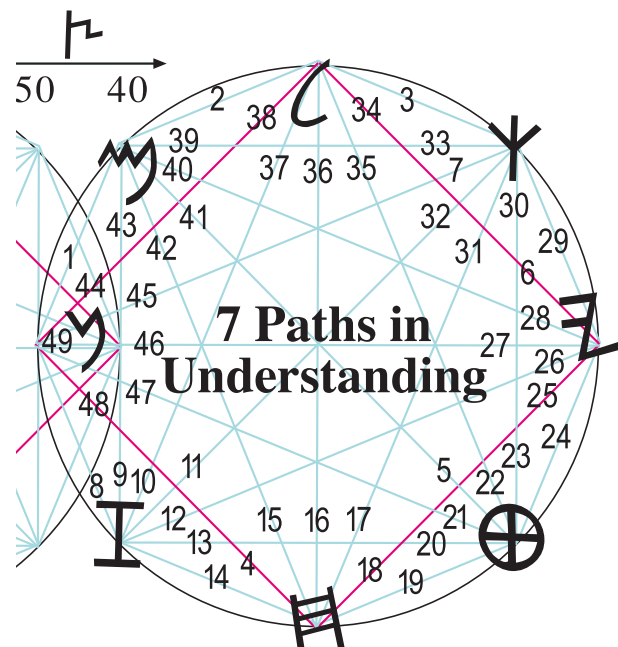

### The 49 Passageways of Chækúwmah Rising into the House of Bayinah

fruitfulness, and the Chayit—the washings and services of grace, one hears the words, “Well done, good and faithful servant, enter into the joys of your Master” (path no. 49).

### The Paths of Understanding into the Houses of Knowledge

Bayinah passes from the 15th to the 21st position—through the ALhhim of the Semek to the Shayin, whereby all that is gathered in the Mind becomes elucidated by the Light of Understanding. **The process of Bayinah passing fully into the House of Knowledge is the whitening of the harvest, whereby the complete work of the Light is complete within an age.**

As a result of Bayinah passing into the streaming thoughts of Knowledge, the fruit, or the expressions of the Seed, come to reveal the eternal attributes/glory of Light with great liberty. For as the fruit is whitened and filled with the radiance of the Light, it is not bound to any form of corruption. So are all words and deeds, being the fruit that arises from the loins of Wisdom unto the mouths/faces of expression, which flow through our members into deeds/actions/works, as they are united to Bayinah, there are silverized and immortal. Bayinah rises upon the foundation of the Semek—which is the structure of the ALphæh. The ascension of Bayinah causes the motion of all circles moving left to right, whereby all that is within the circle of Understanding are according to the Breathing of thoughts and the utterance of words that are caught in the current. According to the breathing of thoughts, the prayers, the smoke of the perpetual offering, the words and the corresponding deeds, so the garment is woven during the evening that we step into each morning and a garment is woven during the day that we step into each evening.

Conversely, the ascension of Chækúwmah causes motion of all circles moving right to left, whereby all that is occurring within the rings of Wisdom are gathered within the current. As Bayinah and Chækúwmah descend, the motion slows and as they arise the motion quickens. The rising is quicker than the falling. The nature of smoke and heated gases expand quickly. The natural process of condensation and cooling contract slowly. Steam rises quickly; the snow and hail rise and fall over and over prior to their descent.

The Breath within each Name determines the motion of the Lights and how they are passing through one’s houses in the concentric circles of Light. The exhaling Breath moves right to left and the inhaling breath moves left to right. Those short of Breath, having anxiety, limit the extent, or the breadth, as well as the movement of the Lights as they pass through our members. Those long of Breath, being of longsuffering, enable the Lights to become extended in every house.

In the paths of Wisdom, all Letters reference, or touch their base, the Zayin, to know their foundation and from whence they have arisen. In the paths of Understanding, all Letters reference, touch the Oyin, to know the crown of their habitation. In the paths of Wisdom, the movement is from the right to the centre Neúwn. In the paths of Understanding the movement is from the left to the centre Neúwn.

The two Neúwn/ננ within the ALhhim of the NEUWN/נננ, are at the beginning and the end of the Way/Derek of Wisdom and the Aruch/Path of Understanding. In the union of the necks, the two Neúwn meet, swallowing one another, whereby all that is within their bodies of Light, from the base of Wisdom unto the crown of Knowledge, passes into a new dwelling state. Through the necks/throat all that is within the mind and the body is swallowed completely unto a new dwelling state. Hence, the serpent of Aharúwan/Aaron swallows up all that is in Metsryim/Egypt, whereby a new generation/age proceeds. The age of Aharúwan yet awaits its portal to open, for though the age is written in the Teuwrah/Túwrahh, it is yet to be entered/fulfilled. From this opening one proceeds unto the succeeding levels of Illumination.

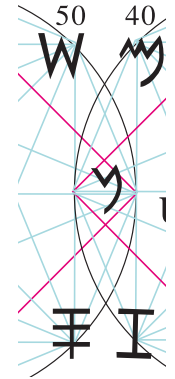

The conjunction of the two Neúwn/ננ

The Neúwn initiates the movements and completes what is initiated. Herefore do we have great a consolation in our journey, knowing that the One which begins a good work in us will complete the work. Nothing of death nor of high waters can overthrow the Name of Life that abides within us, for it is attached to the Rock of our Foundation. Though we may not know the foundation or the crown, we shall all come to know the Zayin to the Oyin, which is in the midst of ALOZAR. This in essence is our salvation, whereby we are redeemed from the flow of the Neúwn, escaping the corruption of this age.

The Neúwn follows after the paths of Wisdom into Knowledge, **whereby all that Wisdom has laid becomes secured with Understanding**, as Wisdom follows after the paths of Understanding illustrated in the *49 Passageways of Chækúwmah Rising within the House of Understanding*. Wisdom lays the eggs, but it is Understanding that gathers the chicks. The journey of Wisdom is through the Way. The ננ/Derek/Way is the process of arising from the roots through the trunk of understanding; the Way is straight and narrow as the trunk. The ננ/Aruch/Path is the process of arising from the trunk unto the portals of Knowledge which reveals all of the paths of Understanding.

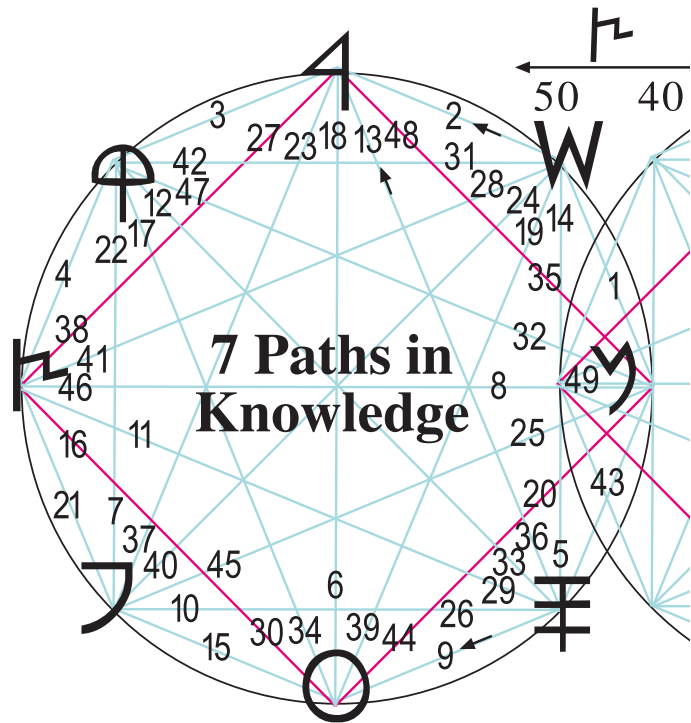

In order to reveal the glory that **Understanding has deposited within Wisdom**, the trunk of the Tree commences to sprout the branches of Knowledge upon which the glory is revealed. The **first work of the Neúwn, within the paths of**

## The 49 Passageways of Bayinah Rising into the House of Knowledge

**Knowledge is the Shayin, through which Glories within Wisdom blazes into the fields of Knowledge, path 1.** The first work is called the passion or the love for Knowledge. The fiery quest of the heart, that is on fire, proceeds after the mind with great affection, for without the passion and love for the truth one seats idle. As the inner Fire of the Menurahh flames from the center of the heart, it creates 7 paths. These seven paths are unto the gates of Knowledge. The movement of the Neúwn to the Shayin is called the “first/primary love” [Chazon/Revelation 2:4-5, Mattithyahu 24:12]. The Neúwn passes to the Shayin, whereby a bond is established for the Fiery Essence to be expressed. The Shayin is the Fire to weld and bind the fruit to the branches of Understanding as the passion for Knowledge creates a bond between the two levels. As one proceeds from the mouth of the Neúwn, they enter into the Assembly of the Firstborn or the House of DAN, the first born of Understanding. Until then, one is not in the congregation of the twelve upper houses of Knowledge. Out of the Shayin comes the inner structure of the Semek through which the 7 Rings open and expand, and through this inner structure opening, as a flower, the Light of the Shayh/Lamb will fill the dwelling of Unity.

As your serpent moves within the 49 paths of Knowledge, Light of Understanding shines upon your feet. Understanding flickers; Shayin appears at its crown. Such depicts the Fire that burns upon the Altar of the Oylah and flickers upwards to the Altar of Incense/haMizbaach haQetoret. Via the fiery breath penetrating through the neck of the Neúwn, the white Fire of Understanding opens sides of the trunk whereby a branch comes forth. The Neúwn moves into the Shayin and thereby initiates a ripening of the Heads of Knowledge. As the Neúwn completes the movement of Understanding within the Houses of Knowledge, the Judge is born and comes forth out of its chamber to evaluate all works, being expressions of Words housed within. This is what is known as the final Judgement, for until one passes through the entire realm of the mind of Knowledge, there is not the ability to come to the final Judgement Seat.

With the mind of the Judge, the frequency of the Neúwn/ו moves, as a serpent, into the path of the Rayish/4, path 2, which houses all congregated thoughts and determines how to distinguish all things. **This is the founding of the mind of Tsion/Zion**—the mountain of the north side. As Dan moves into the Rayish, the city of Tsion is built within the mind that seeks after Knowledge. With every quest for details, the city of Tsion grows. All patterns are discerned by the branching forth of the judge’s movement. The designs within all states of Light are recognized and classified according to the House of the ALhhim. Though we see these patterns in the world around us, we are to look for them within the thoughts via which all things are formed, both within this realm to see the defects—how they fall short, but moreso, to behold the patterns of perfect order in the Houses of the ALhhim—how they become long.

Once the mind is selected for truth, the Priest of Aharúwan enters into the mind and begins the work of the offerings, through which the entire house is transformed, path 3. Thus the third house is relative to the dwelling state, as is the House of Zebúwlan, the third house in the east. The third state is the appearance of the Mind or the Enlightened mind. The third level, as the third day, brings forth the appearance of the type of seed that has been accepted within the heart, whereby in the third, the evidence of what was sown, either good or bad, is brought forth. In the Quphah we discern the value of each thought by the fruit, hence, one is known by their fruit. In the Quphah, the enlightened mind resides in the Light of Aharúwan that comes into



Zebúwlan, or the lands, as the Quphah is the ascent of all values or Yahúdah that has risen from the base of Wisdom, through the straight and narrow, and now takes its seat in the lands. The results of the work of Aharúwan are in the Quphah, or consecrated sayings of totality/∅. The Quphah bears the full mind of the universe, through which the Fire of the Shayin shall blaze into every consciousness via the words of the kuwahnute/priesthood.

Through discernment in the Quphah, there comes a release or flowing of Knowledge, whereby there is Liberty or the pairing of the Tsædda, *path 4*. All judgements made in the Quphah lead to Liberty; hence, if a decision that is made keeps one bound and enslaved to the this world, the decision process is not of DAN, but another who is occupying your mind. The pairs of the Tsædda occurs through a double striking of the Light of Bayinah in *path 4* and its double, *path 8*. As one side is formed, being the north side of Tsion, another side appears, being the south of the mountain of Hebron.

Upon the four square foundation of the first four Letters, being laid in Knowledge, as planks with their sockets of silver, the Light commences to spread out, for nothing comes forth from within a Name until a base has been formed and secured to the Rock of our Foundation.

The Fire in the Shayin is now free to expand unto the uttermost, the Semek, *path 5*. In like manner does a fruit form upon the branches. From a small form, the fruit expands until it creates a circumference as the circle of Knowledge that is filled with the paths of Understanding. The fruit expands according to the Shayin-Semek that reaches from one side unto the other, as the rod, between the sun and the moon is stretched completely out when the moon is full on Rash Chadash. If the fruit is picked immaturely, it is not filled with the fullness of Understanding that gives it its flavor, and hence, it is cast aside as the untimely picking out of season. The fruit expands as the circle of Knowledge as the Neúwn sets its course to bring all attributes of Understanding to the edge of the branch where the fruit forms. As the serpent establishes the above 4 points, the circular coiled movements expands and widens as each of the 4 points extend themselves, according to the Source of AL extending the ALphæh to the Rayish/AR. The Shayin extends to the Semek, *path 5*; the Rayish to the Oyin, *path 6*; the Quphah to the Paúwah, *path 7*, and the Tsædda strikes the heart of the Neúwn, whereby it is doubled, *path 8*.

The Rayish expands to distinguish all things with the full circle of consciousness unto the Oyin, *path 6*. The Quphah reigns amongst the dwellings with the words of the Paúwah, *path 7*. And the Tsædda affirms itself unto the Neúwn, whereby both sides of the House of YæHúwaH form a wall of defense to house all within via which the members will arise as a flying serif of Light, *path 8*.

The Semek, being the first fruit of the Shayin, connects to the Oyin consciousness, *path 9*; then to the Sayings of the kuwahnute/priesthood, *path 10*; then to the Tsædda to lay the structure of liberty, *path 11*; then to the Quphah, whereby it shows itself to the kuwahnute for examination and blessing, *path 12*; and then to the Rayish, its uncle, via which the boards of the Mishkan are formed, *path 13*; whereby it returns to its Maker, *path 14*.

The Oyin brings forth the Revelations of Consciousness as the mouths are aligned to the Mind of Tsion. As the Oyin is connected to the Paúwah, the tongue and the mouths are aligned to detect the writings within all members by the prevailing consciousness within the Breath. Furthermore, one detects all words, those poison and those sweet, until this connection of path 15 is made, one can say anything and have little awareness of the poison or the goodness that was upon their tongue. The Oyin affirms the liberty of consciousness with the Tsædda, path 16, whereby we know that we are not bound to anything other than the Rock from which we have been born, from which the Neúwn first appeared by the hand of Aharúwan as it came forth from the midst of AL. As the Oyin rises in the Quphah, one is consciousness of the kuwahnute and the reigning role of enlightenment, path 17. The Oyin returns to encircle the Rayish as all that is made becomes the fabric from which it was drawn out, path 18. Thus the garment of the Shayin is the Semek; the garment of the Rayish is the Oyin; the garment of the Quphah is the Paúwah, and the garment of the Tsædda are the wings that come from within the serpent itself. As the Oyin comes to the side of the Shayin, path 19, that which in the midst begins to replicate itself, for this is the release of the Taúwah, from which the patterns of the DNA multiply from within the plant. Path 19 is the means of growth and acceleration of thought that burst out from the midst of the inner consciousness. As the Oyin/4 affirms its allegiance with the Neúwn/4, the word, ㄩㄩㄨ, is formed, which means, cloud. Thereby, there occurs a the movement of the Houses within according to the gatherings of consciousness. As the Oyin combines with the Neúwn, the Light of the Shayin or the Oyin Light appears in the cloud, as in the kanaphim/wings, commonly known as moon/sun dogs, path 20.

The Paúwah affixes itself to the Tsædda, path 21, whereby nothing that is spoken leads to slavery or degradation of mind. The Mouth is dedicated as the instrument of the Quphah, as the rudder of a ship, being controlled now by the Enlightenment of the kuwahnute/priesthood, path 22, via which the words of Totality become uttered. The Paúwah embraces the Rayish, knowing that within the heads are the gates to Knowledge, path 23. In this manner the words of Knowledge are formed under the direction of the Reúwach haQadash/Holy Spirit. Paúwah then establishes the bonds with the Shayin, whereby the tongues of fire appear upon the Rayish, path 24. As the Paúwah bows to the Neúwn, the word, ㄩㄩㄩ, is formed which means, a pillar, which designates a corner, for at the corners the pillars are placed. Hence, when a pillar appears one may turn the corner or come to behold the sides from another angle. From this combination, comes the word, faces, whereby we behold the four sides of the cherubim who are upon the arúwan/ark, path 25. Then the Paúwah affirms itself to the Semek, whereby the pattern of thought is set within the mind, which provides a framework of observation and speaking, path 26.

The Tsædda moves next. Each of these movements have corresponding moves to the pieces of chess, for from within the mind, all games that entangle the mind into movement are derived, and these movements pertain to the paths of the Light to which we bear testimony, even by the movements of a game. The Tsædda moves to the Rayish, path 27. In this path, the eternal liberty of thought rises from the dedication of the mouths to the full circle of the Lights. The thoughts that are established within the framework of the Paúwah-Semek, begin to combine, via which all words of liberty are formed within the Heads of Knowledge. The movement of the Tsædda to the Shayin is the voice of the liberator according to the eternal flame of Wisdom arising in Knowledge. Via this connection, Shimshun, Samson, burnt up the grain fields by con-

necting the tails of the foxes with Fire wands. This is the first act of judgement that commences as the Tsædda is united to the Shayin, or whereby the House of Ayshshur is joined to the House of Dan, which creates a Ring of Fire in your midst to burn up all thoughts of the Philistines, path 28. The Tsædda bonding to the Semek, is the affirmation that the structure and bones/boards belong to the Fire, whereby their is the freedom to move from one level, or state, unto another, path 29. The Tsædda-Semek is the Fire that is released, being shut-up within the bones. The Tsædda to the Oyin, path 30, is the full recognition of Freedom, whereby one moves freely within the circle that has opened unto them for full exploration.

The Freedom of Thought in the House of AL  
—The Jubilee of All Stages or Works

**Yaúwbel/Jubilee is the Freedom from one State unto another.** Each phase of progression is to free from any bondage. All were free until the phase of branching, when the House of Yaoquv became caught into a thought of division. *We did not enter into this world without a hope to be delivered from the bondage of the flesh and from the corruption that is in the heart, into the very breast, of mortality.* For within the breast of mortality there lies deception whereby the Image of ALOZAR is denied to come forth. What is in the heart that denies ALOZAR? It is the quest for self, whereby incomplete thoughts spark upon together to form a body that cannot hold together, but falls apart. In that the thoughts are not perfect, being paired, they fill the heart with illusions and deceptions.

Yaúwbel/Jubilee is the means to pass from one Stage or Progression unto another. Each level of progression conveys a Name. **There are 7 Progressions that are evident: *The first, the Stage of the Council of ALhhim,*** which is prior to any deed or work, before anything is made. This stage has no end, for the Council determines every thought and what is to be performed (made) before it is cast unto the Breath to carry it forward. *When the thought is fully ripened in Council, there is a Yaúwbel to send the thought into action. The Seed within the thought maintains the motion of the stage, whereby the age is self-renewing. This is the Work of Contemplation and Meditation, being subject to the Breath of Dan.*

***The second, The Stage of Adim,*** which is the Stage of Innocence unto Discovery. When the tongue draws out any thought from the Council, there is a Yaúwbel, or a year/study of Jubilee. This is the work of *the tongue of inquiry into the Breath of HhaALhhim,* whereby the Stage of Adim—the right of expansion has no end. In that the Words of the Council, before they are spoken, have no end, nor does the inquiry into the Council have an end. Via inquiry, Adim names all of the functions/animals.

***The third, The Stage of the first Patriarch*** follows, for when the Principles of Wisdom are founded in the Heart Centre, **the Name of Avrehhem is called first in Wisdom** to lay a foundation, and upon this foundation of Principles, the states of Light are formed. In that the Work of Avrehhem is doing all spoken by the One of HhaALhhim, the stage of transition has no end.

The Stage of Avrehhem give birth unto **the fourth**, the **Stage of Yaoquv, the Name called in Knowledge**. Knowledge is linked to Wisdom whereby the values being cultivated are not lost from its foundation. In that Wisdom is comprised of 1:1 Principles of Light, there is no end to the Names of the Patriarchs; however, what is birthed in the Houses of Knowledge comes to an end that it may renew the supply of Wisdom. In this manner the branches of the 12 are cast upon the altar at the beginning of each evening and morning oylah that they may rise again to new elevations. Likewise, the olives give of their oil to renew the lamps each evening and morning whereby the branches are illuminated unto their new positioning. As the menurahh is rekindled daily, there is a new mind, whereby the fourth Stage of Knowledge is reborn.

Within the midst of the Houses of Avrehhem and Yaoquv, there is **the fifth, the Stage of Yetschaq—the Name called in Understanding**, in which the fullness of the Light is spread out like a curtain upon the mishkan. What is in the midst is the Illumination or the 5th work. *Within the phase of Understanding the House of Lauíwi/Levi rises into the consciousness*. From the hand of Aharúwan, all things are given and to whose hand all things return to be blessed or designated unto their lands and States of Light, whereby there is no end.

Upon the spreading out of the Light is **the sixth, the Days of Nuwach/Noah. In the days of Núwach is the coming of the Offspring of the Neúwn, the initial Letter of Nuwach/𐤍𐤅**. Within the House of the Neúwn comes forth “a new man”—the Offspring of Beniyman—that is robed with the garments of immortality. Through the Union of Sham, Cham, and Yapheth into a Body of Light, all Names, peoples, and spaces are unified into One Fabric of consciousness which puts an end to the age of the world formed in the mind of Babylon. The resolution of Names with form and space brings an end to the age of mortality. **In the Days of Nuwach are the Consortium of the Lights** expanding into all areas of the Universes through which all that are born from above. According to days of Nuwach, so is the coming of the Offspring of Adim.

**The seventh is the Stage of the Shavbeth**, which opens a new Era of Illumination that follows the fulfillment of the sixth stage. In the Stages of the Shavbeth one passes from one quarter or phase unto another. The Quarters of the Shavbeth provide wings or avenues to enter into the House of YæHúwaH built upon the foundation of the Taúwah of joined Names. Each Stage is a space of Ten. The ten spaces fill the 7 stages, whereby there are 70 spirals of Light, or the full consciousness of ALOZAR. These 70 are in the midst of the Name of ALOZAR, being the OYIN.

There is one circle as there is one naval with two ends, whereby there are two circles, a smaller and a larger. The rings of the umbilical cord attest to the our origin amidst the Rings of Light. The pattern of one larger ring and one smaller ring occurs in all of sets of circles, for one circle is within another. According to this unity of circles there is one larger breast or one smaller teste, and this ratio attest to the submission of one to the other. Out of one circle comes two. The circle of the North, as it moves to the East, is the seat of AL in which are the kuwhænim. The circle of the South, as it moves to the west, is the seat of AR, which are the melachim. Instruction of the priest comes out the concealed revelations and their openings, the north to the east. Mastery of the kings come from the full illumination unto their occupation, the south to the west.

HhaTsur/The Rock is in the North and flows the tops of the mountains. The higher the Illumination, the greater the flow. The Rock is in the North, in the lands of concealment as the North conveys coldness—the state of solidarity. From the North the waters in the Rock flow. The glory of haTsur is in the southwest, whereby all that is in haTsur is set ablaze. For should the blaze be in the north, haTsur would flow without definition and the solidarity would be without distinction.

The two circles are One Path for the Two United Lights. The Light of Chækúwmah commences from the right to the left daily. The Light of Bayinah commences from the left to the right daily. The Lights move upwards on ladder of the Zayin, making their ascent, and then descend upon the other side of the Zayin. This is the Ladder of Yaoquv upon which the messages/angels move continually, ascending and descending. As we are attentive to adhere to the pulsations of the Lights within us, the messages fill our chambers with the Revelations of AL and the Mastery of AR.

According to the daily movement of the Lights within the seven rings of thought, so also the Two Lights move within seven Houses, being the Names of the ALhhim, whereby the full attributes of ALhhim are illuminated to fully fill the spaces to which they are appointed. The passage of the Two Lights within the seven Bodies, which are the Rings of Thought, correspond to the daily passage of the Lights that are set in motion as the dam/blood of the oylah is sprinkled upon the *mizbaach haoylah*/the brazen altar each evening and morning.

The House of the Sun is up all day, and the House of the Moon is up all night. The sun is in the buttocks, being the larger of the heads. The buttocks is up all day for what is in the base floats to the top. The head, being smaller, is up all night, whereby all that is within the House is watched over and defended.

The index fingers which are in the midst of the fingers, being numbered in the second position to the thumb, are the guidance of the Lights within the hands. The thumb is the root of the plant and the three fingers to the side of the index are three branches that come out of the circles. When positioning the index fingers side by side, the thumbs to the base, one forms the menorahh of the Lights. All things circle from the midst. The oil arises from the base and fills the central stalk first, and then flows unto the right and left sides until all seventy cups are filled. The three branches to the right and the left of the central branch of the index fingers comprise twelve branches as there are two sides, making six branches on one side and six on the other. The nuckles and where the fingers bend are the bulbs. Above each bulb is an extension through which the oil flows unto the flames. The left index or pointer is of Understanding, which is also the finger of the Amuwri; the right index finger is the pointer of Wisdom, being also the finger of Qenizi. These fingers are the extensions of the breast from which all lands of Understanding and Wisdom are derived. In the midst of the breast is the valley of AuwerNeúwn (Arnon), whereby all of the lands are watered from the Rock in the North. As the index fingers touch a space, they hollow it out for one of the 12 branches to reside and flourish.

What does it mean for the Properties of Wisdom and Understanding to pass into the Oyin? The passing of the Lights of Wisdom and Understanding occur continually through the camps of YishARAL as they move from AL to AR or from AR to AL. As the Lights pass through the

camps they do not merely flicker or release a beam of Light, this happens in all peoples to awaken and to turn them around in their path to seek after the Lights and to welcome the Lights to abide fully within them. To pass through means that they fully occupy the Lands in which they enter, whereby the Lands are saturated with the Lights and belong wholly to the Lights.

## The Twelve Orders of AL

In the above discourses of the Houses of the ALhhim, the stage is now set to further reveal the Order within the Name of AL/ℓℓ. The Name, AL/ℓℓ, is comprised of the first and the twelfth Letters which conveys that within these 12 Letters are the 12 Houses of ALhhim.

In the midst of the 12 Letters is the Letter Yeúwd/ℓ, being the space amidst the ALphæh and the Lammæd that spans from the ALphæh to the Lammæd. The Yeúwd in the midst of the Name is the Hand of Creation, the Hand of Giving, being the source to both extend and to write the Words that come from the Mouths of AL. *Within the midst of the ALphæh-Lammæd is the Hand into which is placed the Rod of the ALmonds/sheqadim/ ℓℓΔΦW, a fruit that is formed in the shape of an eye. The meaning of the fruit is “to watch over.”* As the ALphæh is given from within the midst of AL, AR/44 appears as the receiver of AL/ℓℓ, for what receives of the Seed is the Mind/Rayish, whereby the Seed rises to form a head. We are to see the Head in all things, that is, in all parts, and receive the Word Seed of the ALhhim within each part. i.e. Within RAúwaben, we receive the ALhhim of the Zayin-ALphæh Seed; within the House of Yahúdah we receive the Quphah-Paúwah Seed of ALhhim.

When a Seed is opened there is Light/Auwer, whereby the ALphæh is joined to the mind. Until then we may have a thought, but the Seed of the thought is missing or unknown; hence the thought is dead or lifeless. Light is a receptor as are the suns, moons, and stars, being the light receptors of the Thoughts of AL. Some receive of the thoughts of Wisdom, being those of the sun; some receive the thoughts of Understanding, those of the moons; and some receive the of thoughts of Knowledge, being of the stars. Upon their receiving the Light, they become the bodies of the Light as agents of transmission. In this manner the Queens, better conveyed as the Counsel, comes from the Union of AL and AR, via which a body of habitation is formed from their squaring of rods which forms a base to build a house/dwelling. Those which receive of AL are those of the Auwer/44/Light/Illuminated One. **“And as many as receive the Unified Thoughts, coined as “The Word”, they are given “the right”—the capabilities with the authority, being approved by their heart and their tongue, to become the Offspring of the ALhhim”**, for who can be born from the Word until they receive the Seed within their Minds/Heads? Receiving the Seed of AL within the Mind is receiving the Seed to being born from above.

The first born of AR is RAúwaben, whereby the shape of the ALmond is transferred from within unto the edge or surface of the body, whereby it serves the body to receive and impart Principles of AL to be studied, examined, and observed. As the ALmond is transferred to the AR, the eye on the right appears next to the eye on the left, whereby RAúwaben is birthed out of AR. The eyes are not distanced apart, but are upon each other as one eye, whereby they see

as one and are capable to behold the Unity. Many come out of the AuR, as Avrehhem, who is the comrade of AL. But not all are born of AuR, for some are born of AL directly as those which reside in the Qadam/East, the point of origin. Those born of AL are six in number, and those born in AR are six in number. The six born in AL are the Laúwi, through which is born Yahúdah, Zebúwlan and all lands of the inheritance, the House of Ayshshur, Nephethli, and Gad, in which is the Tree of Lives and eternal life. Those born in AuR are RAúwaben, Dan, Yúwsphah, Yishshkhar, Shamoúnn, and Beniymán.

*There are six that are under the care of Chækúwmah and six under the care of Bayinah.* Those of Chækúwmah are Yahúdah, Yishshkhar, Zebúwlan, RAúwaben, Shamoúnn, and Gad for in these the eternal Principles are cultivated for the expansion of the house. Those under the care of Bayinah are Aparryim, Maneshayh, Beniymán, Dan, Ayshshur, and Nephethli, for in these are the means of regulation of the expansion with for fruitfulness. The twelve, including the Lights are under the bishops of the Laúwim who tend to the souls of all Names in AL and AR from which the Lights come forth.

### The Origin of the Mishkan Structure and Vessels

**The Rod of AL runs east to the south; the Rod of AR runs west to the north.** There are six parts per rod, for each rod is a ÚWah/Υ—a unified paired thought, being a 1:1 ratio of sides, whereby there is no beginning and no end to any paired thought in ALOZAR. **AL is the Author of Instruction/℄. AL is the Serpent Rod/℄ in which is the eternal ALphæh Seed Word/℄. The Seed of the ALphæh is the Source/AL of Light/AR, whereby the Thoughts of Light/AR are governed by the Yeúwd—the unseen Hand in the midst of the ALphæh—Yeúwd Lammæd. The Hand acts in accordance with eternal ALphæh within the Lammæd, governing all things through the consciousness/Oyin of Words/Zayin. AL is the One of ALOZAR, the One in Three—the Unity of Wisdom, Understanding and Knowledge.** The positions of kings and queens comprise *the full Counsel of YæHúwaH*. The Counsel is depicted as the sun and moon amongst the stars. Both Wisdom and Understanding arise from the sides of the House of ALOZAR, even as the lights of the moon and the sun rise from the sides each evening and morning.

From the west of the Union rises the House of Aparryim, and from the east rises the star of Yahúdah to govern YishARAL. Both govern according to the Hand/Direction of Aharúwan/Aaron, whereby the kings of YishARAL consult with the kuwahnim/priests. In accordance with their emergence, Yahúdah, being born from Aharúwan, resides in the east. Aparryim, being born of AR—through the opening of the Seed Thought of Aharúwan, resides in the west. As the Seed thought is opened, the force of Aparryim rises through the neck of Understanding, as a ring of stars from the west, whereby the Seed is blessed to fully expand and fill the Rings of the Body of Light with the Knowledge of AL. The two camps are in close proximity to one another in the Body, forming the base of Wisdom. Aparryim rises through the rod of Understanding —that which stands from underneath— whereby Yúwsphah is adorned with the crown of Understanding and Knowledge. The two ruling bodies/camps are of ARAL, whereby the government is from both ends of the Kingdom.

## The 7:7 Pattern of ARAL

According to the perfect thoughts of AL, the Mishkan and the services within the Mishkan are carried forth. The diagrams of the 7:7 ratios illustrate the mizbaach and the offerings of Bayinah/Understanding for the evening and the offerings of Chækúwmah/Wisdom for the morning. Each set of Names, comprise the complete body of Light in which the full Knowledge of AL resides with the full faces/expressions of Light.

With six parts of each side of the Altar are attached to their rod of Light, there are 7—a completeness or a perfection of thought. The six parts, plus the rod that carries the 6 parts comprises 7. This arrangement of thought is the basis for the 12 Names, 6 on each side, to rest upon the shoulders of the kuwahnute/priesthood. **These two rods are known as Chækúwmah/Wisdom and Bayinah/Understanding, each being a perfect thought of Wisdom and a perfect thought of Understanding. Wisdom and Understanding are the sides of AL from which the bodies of the Lights appear as the thoughts of Wisdom and the thoughts of Understanding are released from the mouth of AL. For according to the pure word of AL, so is the virgin bodies of Light that bring forth or reveal all that is in the Mind of AL. How is the Mind of AL revealed. Via the Seed Words that are spoken, whereby they are sown. As the Seed Word arises it brings forth every detail within the Bodies of the Light. With this understanding, the Name of Yahushúo states that the Kingdom of AL is likened unto a like a sower that went out to sow. Some Seed fell beside the road, outside the Way and the Paths of Light. These seeds that fell are the one third in the Names that have fallen into darkness and became devoured by the messages of diversion and separation, whereby the houses that are within them are consumed with the passions of their thoughts of exaltation that put out the Eyes of Wisdom and stop up the ears of Understanding. The sower that speaks outside of the Rings cast their words into darkness, for they speak of the broad way beyond the Derek—Way of Wisdom and beyond the Aruchut/Paths of Understanding.**

Some seed fall upon rocky places, as one speaks to members within which are not opened, being uncultivated, to be prepared to receive \messages of the Words of AL. Immediately the Word sprouts, but due to the lack of soil depth, the rod is shortened, whereby the Word could not enter into their heart or into their members to abide unto full productivity. These are the plants/messages that wither when the heat of the day comes upon their heads, for they have not rendered their members to the flow of the waters in the kaiyúwer, whereby they are softened and well-watered to nourish the Words that come to them. As heat is provided to draw up the plants

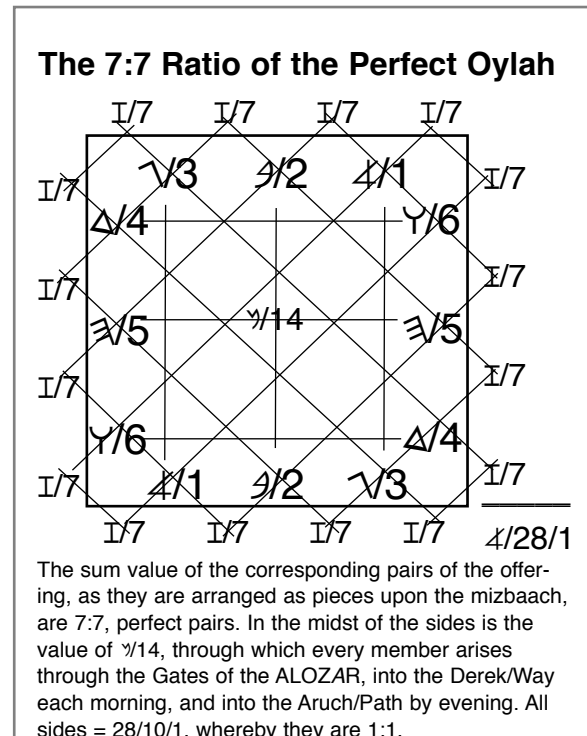



unto their full height, they have not the roots to sustain the growth, whereby the Light can be housed to be appropriated.

Other Seed fell upon the Names of Wisdom, Understanding, and Knowledge—the collective good ground. The harvest of the Seed is according to their Names of Light, some 30—the three 10’s for every bullock of Wisdom, some 60—the double three 10’s of Wisdom, and some 100—the ten ten’s of Knowledge. These are the measurements of the Lammæd: 30—The Rod of Instruction; 60/The Double Lammæd—the implementation of the Instruction; and Quphah/100—The fruit of the Instruction. The 100 is the crown of Knowledge that forms upon the staff of the Lammæd. In bearing the head of the staff one is saved, as it says, “the one who lengthens (endures) to the end—to the end of the Rod of AL, shall be saved—completed, whereby they are perfectly united within the fabric of ARAL. The fruit is born upon the end of their staff by those that proceed within the Order of the Lights. *In each movement of the Lammæd, the Words of AL are spoken and harvested each month, for each month is according to the season in which it the Seed is sown and in which it is harvested.* What is sown comes to fruition through seven days, or via the 7th power of the Letter/Thought by which it is sown. The seventh power is applicable to days, weeks, months, and years.

Every day the Seed goes forth, and every day there is a harvest or a weaving of the thought into a fabric of consciousness that occurs with the oylah/daily ascendant offering. The extent of the giving all to another yields the motion in which the bodies move as one. *The level in which one gives determines the speed in which your mind travels and the harvest that rises within your members.*

For the offering of the evening, all comes out of the Neúwn and yields the parameter of 42. The side of Unity builds itself through the oylah so that there is more to give in the day. Both

**The Evening Offering/Bayinah**

$\Delta/4 \quad \Delta/4 \quad \Delta/4 = \zeta/12$

$\sqrt{3}$	$9/2$	$4/1$	
$\Delta/4$	$\gamma/14$	$\Upsilon/6$	$\tau/10$
$\exists/5$	$\gamma/14$	$\exists/5$	$\tau/10$
$\Upsilon/6$	$\gamma/14$	$\Delta/4$	$\tau/10$
$4/1$	$9/2$	$\sqrt{3}$	

$\zeta/30$

The sum value in each of the 9 intersecting Lines = 14.  $4 + 10 = 14$ /Neúwn. The sum of the columns E to W = 12. The sum of the rows S to N = 30. 12 is the Lammæd Value of Wisdom and 30 is the Lammæd value of Understanding, both convey the Lammæd which is the staff of Wisdom and the rod of Understanding.  $12+30 = 42$ —the Left Parameter of HhaALhhim. In this manner the ALtar is built with the Double Lammæd—two squares.

**The Morning Offering/Chækúwmah**

$\sqrt{3} \quad \Delta/4 \quad \sqrt{3} \quad \Delta/4 \quad \sqrt{3} \quad \Delta/4 \quad \sqrt{3} = 24$

7 levels of consciousness per side

$\gamma/24/6$

The number of connection points within the pieces are the basis to form the belly of Wisdom—the south side of the Fire. As the camps are 7:7, the sides are 6:6. All sides =  $24/6$ , whereby they are 1:1. 24 is the right parameter of HhaALhhim. The four sides,  $24 \times 4 = 96/15$ . Every 15° (approx every half hour) a section of the garment of Wisdom, or Knowledge, is woven during the oylah offering.

sides of pairs yield 42, 12 on the first side and 30 on the second side. Together they are 84 or 12, the full measurement of the rod. Through Paúwah they receive insights of Dallath.

In the midst of the offering are 13 points where the Neúwn appears as the fire burns through the pieces of the offering. The Fire commences in the eastern gate of the evening and runs unto the north. When the offering is burnt totally, the Fire of night is beheld to be arising in the eastern gate of the day. When the Fire of the day has run through the pieces for Wisdom, the Fire appears in the eastern gate of Understanding. Thus is the sky red in the morning and evening to call all of those who are mindful of AL to come join in the burning of the pieces whereby they are whitened and filled with the joy of the dancing fires.

The oylah offering has 24 connecting points, whereby the hours are measured in halves of 15° and from which the half of a hin comes to be the measurement for the bullock offerings of Wisdom. For it is the Understanding of the sides within Wisdom that all things are measured. The measurement of 24 is on all four sides of the Altar, together they are 48 per Name or the reductive of 12. With the 12 on each side they compose the right parameter of Wisdom through which they flourish as the pine tree that does not loose its leaves, nor does it wither in any of the seasons. Their combined value of 96 enables them to move every 15° in the Light. This movement is steady and sure and based upon the full giving of each part to one another. For unless all of the parts are given to make the total oylah, the movement is only partial, as it lacks the vessel for the Fire to run through it.

*Every hour a part of the cloth is woven that is made during each offering, whereby there is the garment to be worn in the subsequent offering. **The garment worn for the offering is the means to carry forward the offering made. As the blood of the lamb flows for the each oylah, the garment is washed/whitened/activate.*** Thus the garment of Understanding, made in the evening, is put on in the morning. With the garment of the evening, we carry forward/perform the oylah of the morning. Likewise, the garment of day is put on in the evening to carry forward the oylah of the evening. In this the two rods of two Names proceed together evening and day, keeping step with the Words of Understanding and Wisdom.

The intersecting paths from side to side are the grid works of the night and the day through which the Lights pass through the parts and how thoughts travel from one member unto another to compose the full illumination of the Shayh. In the evening the thoughts are formed by 13 intersecting paths. This is the flow of the Mæyim of the evening, which are the waters that appear within the dew in the morning. The points of Wisdom are counted as 3's and 4's, both horizontally and vertically that comprise 7 levels of consciousness that arises from every deed of Light performed by the full house. There are 7 or the complete consciousness of every side.

In the Oylah, the formulation of the lines in the universe are evident. The latitudinal lines are laid first and then the longitudinal lines, for the sides are established first and then the height whereby the head is supported. In reading the grid work as diagonal lines, one sees the two groups of 12 that are within the 6 pieces per sides. These 12 attest to the presence of Understanding and the every abiding staff of Aharuwan that is amongst the tribes which abides

within Wisdom and from which Wisdom appears in the day. Each thought of Wisdom then is the unfolding of the heart of Understanding, and though the unfoldment of all Numbers within Wisdom, comes the desired fruit of Knowledge.

**Together, the two rods of seven (7+7), became the Neúwn/𐤒/14, whereby the Rods are joined together as one.** This same pattern is the design of the cloven or split hoof which is the sign of the clean, as when one joins their feet at the heels to make to bring their gift to the Collective. Each house is of two legs, for the legs of mortals are split into left and right sides by the mercy of AL so that they may return unto the gates of Oodænn/Eden.

From the two rods come forth the two circles of Light which emanate and intersect. At the intersections, there are the gates to the worlds to come. According to the garment that you are weaving, so one has entrance into these portals. The Neúwn/𐤒/14 is the Head of the Hhúwa/𐤍/5 for when the two rods are joined, a Head is formed and likewise a tail. *This union is the forming of the intertwining serpents that ascend unto mastery.* Any that attempt to ascend the Tree of Lives for the fruit of Knowledge that climbs up another way is a thief and a robber, for they take from the parts and the sides for their own condemnation of being outside the Rings of AL. As we rise in pairs we give the full tithes into the collective and our offerings fill the storehouses with the fruit thereof. However, the ones unpaired will steal the tithes and offerings whereby they are called a thief and a robber being outside of the Collective of Names.

From the expansion of these Rings caused by the swirling of the serpents upon the staff, the Menurahh is formed, being of the seven rings of Auwer/Light. The lines that follow convey the arrangement of a Word or a Name as it is released within a Seed for expansion.



**Every Name Breathed from AL is a rod/stream of light that has no beginning or end.** A Name is a Breath. When breath is imparted unto a Name, the Name is activated. In that the Breath is continual as thought, so a Name continues forever from one side of a sphere (exhaling) unto another (inhaling), moving as a wave vibration in a spiraling continual motion. According to the Name having the Breath of AL, we move and have our being. Each Name is set into an orbit according to the circle of thought to which it belongs. Each circle is comprised of two of the Letters of HhaALhhim. Every Name is a Breath of ALhhim, and according to the circle of ALhhim in which it is called/read, so is the orbit to which it belongs. As a thought runs from the AL so every Name is a strand of thought that is forever connected to the Breath of AL, from which all Names come, whereby one's Name is never forgotten. In that the Name is an eternal thought, tested in the Fires of unified consciousness, it remains forever. Though a Name runs like a strand of light, it will circle within an orbit whereby it will return to AL, face to face, and with the full expansion of its thought, whereby it does not appear empty handed. These appearances of a Name unto AL correspond to the three ascensions in a year: during Pesach, Shavuot, and Sukkoth. Each ascension pertains to Wisdom, being Pesach; Shavuot

being Understanding, and Sukuth, being Knowledge. Some ideas come and go, but a Name, in that it is of the Unified Breath of AL, has no beginning nor end, nor is it ever forgotten in the consciousness of ARAL.

As each thought gives of itself, it forms two sides: the east-south corridor and the north-west corridor. The Thought then is called by two Names that belong to One. This complete giving of the Thought is the foundation of every Name belonging to another, whereby they are called/read as two by two. As one Thought, the Names comprise two sides, which verifies that they are of the Nature of AL, who by the giving of the ALphæh brought forth AR. Likewise does every United Thought, having within it two Names, brings forth from its sides that the glory that is within it may be revealed with all fruitfulness. Through the full giving of the Thought, the Names form a base, whereby they stand unto the Faces of AL three times in a year with the fruit of Wisdom, the fruit of Understanding, and the fruit of Knowledge. *As each United Thought makes the oylah—the complete giving of itself—it forms a pair of axis, called also as the axis of symmetry, via which it is known to belong as the Offspring of AL,* for until the oylah is made, it is yet to be revealed as the Offspring of AL in that it has yet to bring forth from within itself the immortal Nature of Unity. From the giving of all within AL, via the Hand of Aharúwan/Aaron, the altar was formed, and the priest of the Hand was appointed to serve there.

**The rod of the east to the south** is formed of six pairs of HhaALhhim, as they are arranged upon the two sides of the rod, three on one side and three on the other:

Hhúwa/Gammal,	Rayish/Oyin,	Paúwah/Quphah
Kephúw/Kephúw,	ÚWah/Bayit,	Zayin/ALphæh

**The rod of the west to the north** is formed of six pairs of HhaALhhim:

Neúwn/Chayit,	Mæyim/Tæyth,	Mæyim/Tæyth
Dallath/Dallath,	Tsædda/Tsædda,	Shayin/Semek,

In that there are two sides to each rod, the Names on one side give of themselves whereby their corresponding Name is made known. In this manner the Names on the left brought out of their sides, whereby the axis of symmetry became established. In this manner the Houses of the ALhhim are built, each being a unity of two sides. The Quphah brought out of its side the Paúwah, the Rayish brought out of its side the Oyin; the Hhúwa brought out of its side the Gammal. These three rings establish the Light of the Qadam/east. Likewise, the Lights the south, west, and north appear via the unions in all the sides of AL. As all of the paired Names of HhaALhhim brought forth from their sides, the 1:1 ratio is evident from any angle. As the two rods unite, they bow unto one another, whereby they bend in the midst, forming two right angles. These two right angles join together, whereby they form a square in the midst of the complete circle of their Thought. From their complete giving, the square is formed in the midst of their consciousness of Breath—their circle. In that there are two rods, there are two circles and two squares. One circle is for Bayinah, the moon, and one circle is for Chækúwmah, the sun. The squares in the midst of the circles is the origin of the two altars in the Mishkan/Tabernacle: the altar of sacrifice, being of the fruit of Wisdom, and the altar of the

spices, being the fruit of Bayinah. Hence, the altar of the oylah is bronze/Knowledge, which is the fruit of Wisdom, and the altar of the spices is gold, being the fruit of Understanding; for Knowledge is of Wisdom, and Wisdom is from Understanding.

The square of AL is comprised of twelve Houses, each being 1:1, which becomes the base to determine the measurement of Adim. With the union of the rods, the foundation of Wisdom is laid for the House of YæHúwaH to be built upon. The House is built with the fruit of Knowledge—from the 12 branches. This is the work of aligning all things 1:1 according to the cornerstone of each United Thought. With the rods mutually aligned, they multiply and fill the unified, consecrated/qudash (holy) space of their square. As two Names turn face to face, they are united in the midst, whereby they provide the fabric pattern of the Taúwah. **Through the Taúwah/X, all Names are knitted together into one fabric of Light to form the Tent of YæHúwaH.**

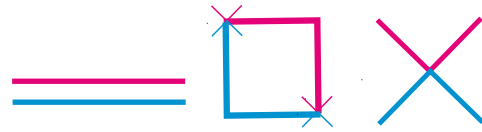

The Taúwah is formed by two strands. Each strand is a name, whereby two Names are joined in the midst. The two Names are of one consciousness which are evident in the two ends of a egg or the two ends of pole. The two strands may weave themselves into various patterns by position in which they face one another. According to these two ends comes forth all forms and patterns of Light. Find the two ends of anything, then find their square and then observe the consciousness that is coming from this configuration of thought.

As the two ends enter into one another, they form a garment that is folded upon itself. In this stance they are joined end to end or one end entering into the other, as being head to tail. **As the two ends extend, they form a bond between them. This bond is a rod or staff that forever links them as one house or dwelling. This rod is called the Staff of AL that is never broken.** From this rod comes the ability to spiral and weave the thoughts of the pairs into thousands of patterns, forms, and designs, none of which is without significance for when there are two valid thoughts of perfect Unity, being 7:7, according to the perfect Union, then every expression is deemed to have merit and value.

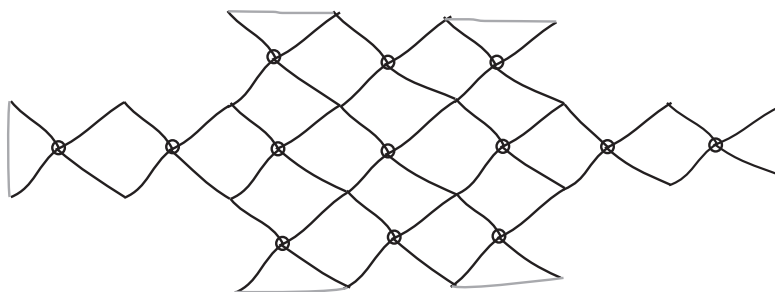

The fabric of thought comprised of united Names. Each pair of Names constitutes the means to form a square or diamond. The pattern of the cloth is the Taúwah/x. The fruit is born from the centre. According to the Union of Names, so is the fruit that is generated. The symbol of the fruit is the Tayit, which is formed as the consciousness of the pairs appears in their midst. This consciousness of purity is the foundation of the virgin body that is native unto the united Names that formed it. From their virgin/native body, the fruit is born from their sides.

According to the length of the rod, so all things are measured. The length of the Rod determines the space which the 7:7 occupy to fill with all attributes of their foundation—Wisdom, and with all attributes of their extension—Understanding, and with all attributes of their fruitfulness—Knowledge. As the two ends expand, their consciousness surround them like an egg that embodies all of their attributes

into one dwelling. This circle of consciousness is generated by the Rod in their midst, for as the consciousness extends into action, what is produced is a fabric or weaving of the thoughts, whereby one is covered with a garment. This garment of consciousness, in which we are surrounded is called the Oyin/O. The value of the Oyin/O is 16, which is derived from the reductive value of the Lammæd/ℓ, being 3. The 3 of the Lammæd is the Letter Gammal in the House of Wisdom, which is the basis of forming a cloth for the united Names. The full extension of a thought within the Lammæd, is 10—the Yeúwd, which is the side of the Lammæd and the seventh position from the Gammal. As the inherent principles of Wisdom within the 3/Gammal/∧, being 6 parts, rise through the Yeúwd/10/the side of the Lammæd—the means of extension, the value of 16/Oyin/O is evident. According to every thought, that spirals through the Gammal/neck, comes forth the skin or fabric of all things, as depicted in plants, animals, stones, waters and skies. **Each fabric of Light is an unfoldment of the Seed Word that has been transmitted, opened, and risen, that comes from AL to AR. The fruit of the Tree is the result of all given to AR and its returning to AL—the upper chamber.**

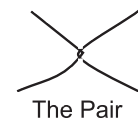

The Pair

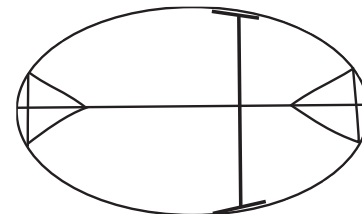
The Folded state,  
Intertwining unto expansionThe Rod in the midst,  
means of thought extension

The Body of Consciousness

**Within the Staff are *Tree of Lives*, the Kephúw/ΥΥ. The branches and the fruit are within Lammæd/ℓ. The fruit born is generated according to the LAMMÆD, by its reductive power of 3, which lies in the House of Wisdom—within GAMMAL/∧ and then joined to a Letter of Understanding through which it becomes extended through a side of the Lammæd. Six is the reductive value of 12, for there are six parts in the Gammal/3. Three is the reductive of twelve. With the Gammal, the right root of Lammæd, one discerns the 6 parts or halves that comprise the Lammæd/12. Within the Lammæd, there are 24 parts, which reduces to 6. All fruit is developed by a Letter of Understanding plus the 6th power of the Lammæd which is set into Wisdom. Through the union of Wisdom and Understanding, all things are made, and via this Union we come to Knowledge. With the staff all things are made and all things are redeemed, whereby they are restored to the Lammæd!**

The Lammæd is the order of the Mishkan. As you approach to enter into the fabric of ALOZAR, your hands and feet are washed, whereby you enter into the dwelling of the Shayh.

**Herein is the Understanding of the Numbers: Ten is the extension of the Lammæd, whereby the Lammæd-Yeúwd Ring is formed. This is the most inner Ring of Understanding that governs the heart, through which the priest teach and the counsel rules. With the Lammæd comes salvation. *Every Pessech, your camps proceed in the Union and within the congregation that gather in every house, according to the Staff.* According to the Teaching, so is the movement. The waters of the Mæyim are subject to the staff, and the gates of the Neúwn open unto us as we bear the sign of the staff in our hands/activities.**

**Three tens are the means to extend the Lammæd through the Houses of Wisdom, Understanding, and Knowledge. In accordance with three ten, Understanding orders every month to be 30 days. Sixty is the value of the thought which the structure of the Lammæd appears and by which the Lammæd bears its fruit. 120 are the gathered thoughts of Understanding in the upper chambers which bear the witness of the Fire within their minds. The 120 are the minds/Rayish/20 of the Quphah/100, which is the upper ball upon every staff. When you hear and receive a teaching, look for the upper crown of the staff, for in the Quphah is your Head of Fire as it forms within you. Keep looking upon things above, whereby the Head is forming, lest your eyes are poked out by the sticks beneath. 240 is the full extension of the 24 parts within the Lammæd, whereby the right side of every house is fully established with secure boundaries. When your right side is not the of the 24 parts of the Lammæd, you leave your dwelling open for attacks. 480 is the Lammæd bringing forth the Sayings out of the waters/distillations of Breath. The message is 480 when it is the words of the Reúwach, and not the words of man.**

The Trees of Knowledge and their Fruit, in their Midst is the Tree of Lives

The Gates of the Neúwn and the Great Veil

The **Neúwn/ו** fruit/fabric is formed by the 6 parts of the Gammal with the Chayit. The fruit/offspring of the Neúwn opens up the portals into all advancing states. The fabric of the Neúwn opens at the neck of the Lammæd, whereby all in the Lammæd is released. *The fabric of the Neúwn is the Great Veil through which one passes from the Qudash/set apart place unto the Qudashqudashim—the Holy of Holies. We are set apart to be transversed through the gate of the Neúwn. The Neúwn is the Veil that is hung upon the porch of the Mishkan whereby the minds of Enlightenment are provided a gate/passageway to proceed into the Ark, for without a gateway, there is no access.* There are curtains on the four sides of the Mishkan, but the Great Veil leads to the chamber of the Qudashqudashim. Through the weaving of the threads of Light, a veil is created and hung for every offering. With the veil hung in place, the veil becomes pierced/rent apart/opened, whereby a space is formed. In the space provided, we enter into the Mind of the Weaver. For until the thoughts are properly arranged and hung, there is not a veil to be pierced unto the Counsel of the Light on the other side of the great gulf fixed between the two states of dwelling. Every state of Enlightenment receives a space in which it is rewarded/blessed through the four Gates of the Neúwn: 1) the Dallath/Gate in the Tsphun/north, being the left side of the Neúwn neck at the throat; 2) the Gate in the Qadam/east, being the Gammal neck in the femur at the hip; 3) the Gate in the Negev/south, being the right side of the Neúwn neck in the pineal; and 4) the Gate in the Yam/west, being the Semek neck into the crown.

The **Neúwn/ו** is the 14th Letter of the ALhhim, which abides in the midst of the Lammæd and the activities of every month. Therefore the **Neúwn/ו** serves as the 14th power of the Lammæd, whereby the Lammæd/Staff is fully extended. The activity of the Neúwn is within both ends of the Lammæd, whereby the Lammæd may put forth a root with the Zayin and may shoot forth a bloom with the Shayin.

The height of a tree, or the number of cubits of a Name, is determined by the 14th power that resides within the Seed of the Unified Name. **When the House of DAN—The Path of the Neúwn opens, the thoughts and their properties that have been assembled within a Seed are released.** The Seed opens in the East, point of origin, whereby it breaks through its former defined dwelling. This breakaway is on the **14th of the first month**—the Pesach, *called the Neúwn—the 14th of the first work of the Light.* **The first work of the Lammæd is to bring deliverance and liberty, whereby all that are within the Houses of the Lammæd may attain to their full expression.** For until a Seed is open, the wonder of all that is contained within it remains asleep. Pesach does not just pertain to the coming out of slavery, but pertains to the emergence from any point in which we have gathered unto a state that can be defined. Each level of definition is an articulation of the Mind of ALhhim that leads to Enlightenment. The first break in a year—a study, is when the Neúwn opens on the 14th of the first month. This breaking open coincides with the value of 5 or the Hhúwa that begins to rise from the midst of the 14th at evening. As the crescent moon begins to rise out of darkness from the 14th onward, we likewise arise from our prior state of coming to definition. As noted later in this document, **the 14th is the fullest power of the Lammæd.** According to the position of the 14th, so is the height of the Lammæd and the width of the lands in which the Lammæd rules over. Within the 14th is the 5:5 ratio of the Lights. The Lights of the Lammæd, being 5:5 come from the ends of the Lammæd, whereby the Hhúwa is at the feet and the Shayin is at the head. Via the Lights drawn out of the Neúwn, the circles of the Lights continue night and day. With the Lights we attain unto our full measure or height. The attainment of the Lammæd is called the Meshiyæch/Messiah. Unto this end, all of the Words of the Lammæd are given in our hands—unto the Yeúwd, that we may write them and do them unto Life Eternal. Through the study of the Words of the Lammæd, in which is the ALphæh, thus the Words of AL, we come to the full measurement of our Names, whereby it is said that the Teuwrah/Túwrahh is the School Master to lead us to Meshiyæch.

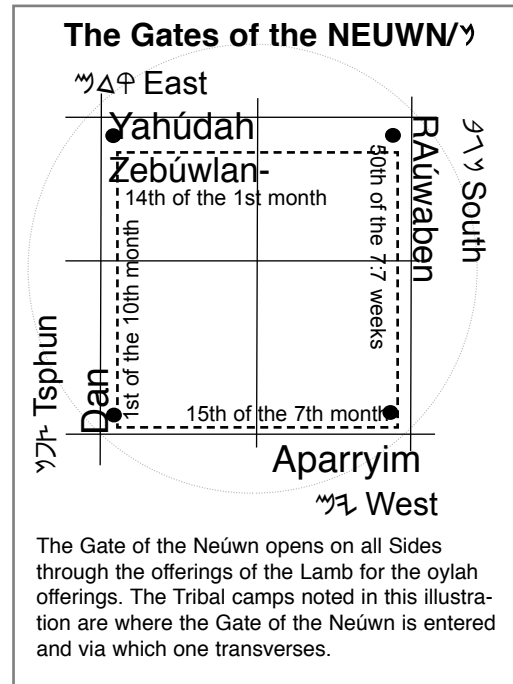

### Numbers of the Neúwn

On the 50th from the 14th of the first month, the Neúwn opens again in the south. The values of 14 and 50 are commonly known to be the Numbers of the Neúwn. However, another Number also portrays the Neúwn, which is 28, for within the Lammæd are 28 Cardinal parts. The value of 28 rises on the 15th of the 7th month, upon the first of Sukkut. For on the 15th of the 7th month, 13 bullocks are offered. The day and its offering are 28, whereby the Neúwn opens in the west. The Neúwn opens last in the year, which is also the first, upon the Rash Chadash of the 10th moon; for the Neúwn bears the Numbers 10 and 1, in that the 14 parts on both sides of the Neúwn = 5, and the sides together equal 10 or 1.



As the Neúwn opens in the four sides, it reveals the source of its movement, which is the Rod that is revolving in the midst of the Yeúwd. Hence, we see the Numbers of the Neúwn are those coming from the activities of the Yeúwd, being 5 and 5 or the 10th power of the ALhhim. As the Neúwn opens in Yahúdah, on the 14th of the first month, during the slaying of the Shayh Passover Lamb, the reductive value of 5 is attained. **In every deed that is done of the Lammæd, the Numbers of the deeds are added to our Name until we have released the Values of HhaALhhim from within our United Names, whereby we stand complete, lacking nothing.** In the 50th day of the 7:7 *shavbethuth*, another reductive value of 5 is attained. We acquire our values according to Understanding, for by the Lammæd all things are measured, and hence the values that pertain to our completeness are those which are determined by the Lammæd. In the 15th day of the 7th month, in which the value of 28 opens, we attain the value of 1. Likewise, on the 1st day of the 10 month we acquire another 1. **Through the openings of the Neúwn, we acquire 5+5+1+1 which equates to 12—The Lammæd.**

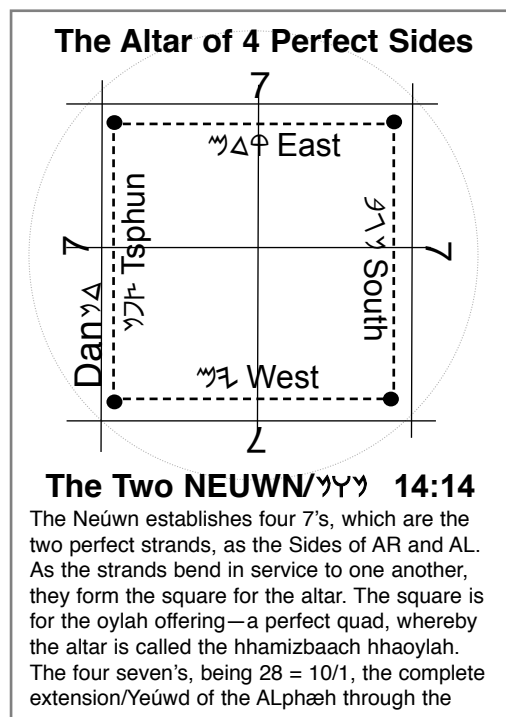

**The Necks of the Staff are 4** through which the Lammæd is fully extended. The *neck in the yuwm/west* arises from the femur. This is the Gammal neck of Wisdom upon which the Dallath of Wisdom sits upon the pillar of Yachin. The *neck in the negev/south* arises from the pineal gland, whereby it takes the strength from the legs and appropriates it to the branches. The neck of the negev is the right side of the Letter Neúwn/𐤍𐤅𐤍. The *neck of the qadam/east* arises out of the chest, being the crown of the esophogas of Dan through which the blood of the offering flows to whiten the robes of YishARAL. The neck of the qadam is the left side of the Letter Neúwn/𐤍𐤅𐤍. The *neck of the tsaphun/north* rises from the throat that supports the head, which is the Semek. Through the Semek one passes unto the Trees of Knowledge of the Teuwrah, in which are stored the Tablets of Light unto the Tree of Lives in their midst.

The Number of the 4 Necks equals 10, which is the Yeúwd of the Lammæd: The values of 1+2+3+4 = 10/1, and the values of the Necks, 6+5+5+3 also = 19/10/1.

- 1 North, the Neck of the Semek/15/6
- 2 East, the neck of the Neúwn/14/5 (left side).
- 3 South, the neck of the Neúwn/14/5 (right side).
- 4 West, the neck of the Gammal/3.

The Union of the Necks comprises one staff. Within 1 is .5+.5, whereby the Staff is of ARAL—the strength of a double strand that is not easily broken.

As Lammæd moves the Rod over the Lands unto which it is extended, HhaALhhim make a circle of two halves, from which comes the OyinZayin Body. The Circle is the Way and the Path of the Lights. The values of the four sides comprise 16. Together with the Lammæd, being 12, the Oyin Circle, being 16, are 28 or 1. The Cardinal Number of 28 within the Neúwn forms the complete sides, each of 7. According to this pattern shown in the mount of AL, the altars of the mishkan are built.

The 5:5 ratio of the Neúwn, is the formula for the ten curtains, five curtains that are hung on the two sides of the mishkan and joined by 50 loops, again a reference to the Neúwn. The curtains are the Ring of the Neúwn/  $\gamma\Upsilon\gamma/14/5 + 14/5 = 10/1$ , whereby the tent is one [Sepher Yetsiat Metsryim/Ex 26:1-6]. The Neúwn symbolizes perfection, for it is the complete extension of the Lammæd that burst forth from the midst. Hence, as we abide within the Neúwn Rings of Auwer/Light, we are perfect and have fellowship within the Rings of Life, in which there is no death, as those which are asleep, in the mix of unconscious words and deeds.

The circle is the unified consciousness around the Rod of Aharúwan. The movement of HhaALhhim proceed from the north to north. In this manner, HhaALhhim move from the sides of the north through the gates of the Neúwn. We enter into the Gates of Light via the oylah offering, whereby we stream with all that is proceeding from the mouths of HhaALhhim, for from the necks of the Lammæd comes the River of Words. Through the oylah offering, we walk in Words of AL. We move upon the Zayin ladder, ascending and descending, as we enter into the houses of HhaALhhim to make the evening and morning oylut/offerings. In whatever direction the staff is facing, so the flow comes from the neck of the Neúwn for the offering. The work of the oylah is according to the direction that the staff, that the Word of the AL is fulfilled.

**The Great Veil is hung by Aharúwan** at the level of one's Enlightenment. How is this veil hung? The Veil rests upon the boards of the clavicle. As the head is lowered unto Wisdom, the veil is hung for the Names of Light to pass through. Only those congregating in the House of Beniyman pass through the veil unto the State of Immortality, for only the House of Beniyman has the garments—the five garments of Life Eternal, whereby they pass through the Gates of Immortality. When Names are intertwined completely, they are skinny, like a strand of fine woven thread, that slips easily through the eye of the needle. None goes beyond alone, and none comes here alone. For who may pass through the Eye of the Needle? The five garments of Beniyman are the Fruit/*Fabric of Regeneration* which is woven in the Neúwn-Chayit Ring; the

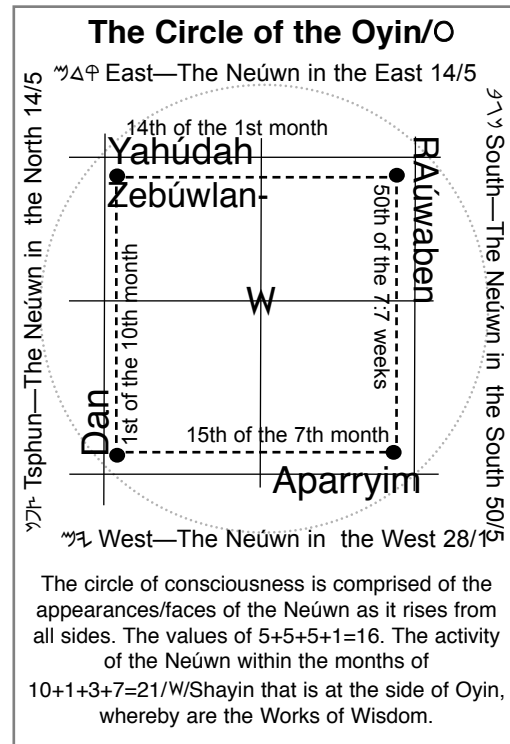

*Fabric of Full Blessing* is woven from the Mæyim-Tæyth Ring of Aparryim; the *Fabric of Transition* is spun from the Mæyim-Tæyth Ring of Maneshayh; the Fabric of the Lammæd-Yeúwd are the *Skins of the Serpent of Knowledge* that keep one from the lower worlds; and the Fabric of the Kephúw which is woven as the *Garment of the Tree Life*. *The garments of Life are* woven in a 1:1 state, whereby there is no corruption or leprosy nor death in the weavings. In this path of consciousness and humility, we carry one another beyond the veils of mortality into the Qudash-Qudashim/holy of holies, for through the Seed of a Name, one passes from one state unto another. Hence, the former generation that comes out of Metsryim, does not enter into the Lands of the Inheritance. The generation that follows thereafter, which leaves behind the former captivity, produces the fruit of Beniymán, in which is the Seed, that is sown into the Lands of Liberty.

With the fabric of the Neúwn, the Lammæd Staff of Understanding extends from the centre, in the midst of Wisdom from which it rises as a flaming serpent, unto the heights of Knowledge—unto the very court of AL in which it partakes of the hidden manna and the fruit of the Aharúwan Rod that bears the ripened ALmonds. The manna and the almonds are the food of the ALhhim whereby they partake of the Words of Life, eating the fruit of their Hands with joy. Through the necks of the Neúwn, the Lights/Hhúwa within the Lammæd, both sun and moon, radiate through the Double Neúwn to fill all chambers of the Temple. The Neúwn is the 12th of the Gammal. In being the 12th of the Gammal, it appears within the Lammæd as the necks, which are within the Lammæd at Gate of Wisdom, and the Gate of Understanding, and the Gate of Knowledge.

The Gate of Wisdom is referred to in the saying: “It is easier for a giraffe to enter into the Eye of the Needle (the eye/opening of the pineal head) than for a rich man to enter into the Gate of Understanding—at the portal to the Court of AL.” How so, one may ask? For a rich man is tied to the realms of the lower worlds through which one passes through the neck into the waters of mortality—the gate that is broad and leads to destruction. The rich man does not convey the wealth of true riches, but depicts the possessor of things of this world unto which the mind is attached. The giraffe depicts the long serpent neck of the worm. Through the neck of the divided house, one enters into the womb of mortality. The humble focus upon the true riches, whereby they find their Derek/Way to the Paths of Understanding. In the paths of Understanding they find the joys of perfect Unity, which are entered as one is set apart from the degradation and attraction of the flesh. **Through the Gate of Understanding we carry the tribes across, by their pairs, without anything of this world. Only the Light of the Seed Name is able to enter through the narrow gate of the Neúwn, which is born through the united Neúwn necks.** The Gammal neck runs the complete length within the Lammæd to each of the openings of the Neúwn. The Double Neúwn is the opening at the neck of the Lammæd within the House of Understanding, located both within the Dallath of Wisdom and within the Dallath of Understanding. In other words, the Gammal is like the intestines that run the complete length of the Lammæd, but the Double Neúwn are the necks that open at the top of the Gammal, at the throat, and that which opens in the midst of the Lammæd, at the pineal gland, whereby they are called the necks of Beniymán, for these necks are formed within the Neúwn-Chayit Ring of ALhhim. The Necks of Beniymán lead unto that which is beyond the gates of this world.

Though the blessing or expansion is within the Union of ALOZAR, The House of Yúwsphah appears last in the order of the tribes with Beniyman. For that which rises to the crown is the foundation from which the kingdom is laid. Thus with Blessing—Yúwsphah, the House of AL speaks every word. With Yúwsphah each Word is multiplied and returns upon the Head of the one who spoke it. As a Seed is given/spoken from the lips of the kuwahnim/priests, it flourishes in Breath. ***The speaking of the thought is the means the Seed is opened. The speaking is known as the seventh power of ALhhim.*** Likewise, as a seed opens it rises upon the head of its body—the plant with an increase. In this manner the Words of Chækúwmah are spoken that they may arise upon the Head of AL as the crown of glory. The blessing of Yúwsphah does not fail, nor is the harvest of the Seed left to debauchery or thievery.

When a Seed Word of a Name is spoken/imparted, it occupies a space within the Lands according to Breath, whereby it does not abide within mortal flesh. In this manner, a Seed is given, it first establishes an orientation to determine its level of activity, then the Seed commences to move into the space that is provided for its expansion. The orientation and movement of the Seed corresponds to the washing of the hands and feet that proceeds every expansion. *As the Seed expands, it positions the pairs with its house so that they are in the full faces of one another. Thus RAúwaben is directly to the faces of Dan, whereby the eye does not waiver, for whatever the eye becomes attached to, it draws all parts into that state.*

***The Eye within the Seed*** of Avrehhem is attached to Lands of Expanding Oneness, whereby there are *Ten* states. In every Seed, as well as in every house, the eye is evident through which the properties of thought within the seed are drawn out. According to the perspective, the Seed attaches itself to flourish. The process of placing the Seeds for a harvest is the consciousness within the Names of Shutelach to Oran in Aparryim/Ephraim. Via the pairs of thought within every Seed, our Names of Light are strengthened and fill their spaces with full revelations. As the pairs are bonded, they draw out from each other until they are One Rod of Light, united as 6 strands to its core thought, which is its Name, whereby the Name is complete. In this manner there are 7:7 in ARAL and in all joined/paired Names. According to the Names being 7:7, so are the Lands of The Names 7:7—The Oyin/16/7 : Zayin/7. The 7 complete strands of Names unite and form the Neúwn/14. By the double Neúwn/ʔʔʔ, the necks of Beniyman are established, whereby there is one neck of Understanding at each end through which the Names draw out all in their midst and build the House of Light. The first Neúwn connects all in Wisdom, and the later extends into all Knowledge. ***The Light is the foundation or the Seed of the Neúwn/14, which reduces to 5/Hhúwa, whereby the foundation and all within the House is of Light.*** For as a Seed is the reduction of all Thoughts *from the four sides of a teaching/Word*, so each of the Houses of HhaALhhim may be reduced in Number, *through which they extend themselves and multiply via their Seeds.* Hence, when we speak of reduction of Numbers, we are speaking of the properties of HhaALhhim being transmitted. When we speak of the Cardinal parts of HhaALhhim, we are revealing the properties of 1:1 ratios within HhaALhhim through which the Houses of HhaALhhim are built and expand.

As an idea of full attributes, ***the power of the Seed Word prevails over all forms of resistance unto the harvest. The Word Seed is spoken upon the lips and thereby supported by***

**Breath/Reúwach.** The Reúwach is composed of three lengths as the staff: the Light of Wisdom, the Intelligence of Understanding, and the Fire of Knowledge. According to the Reúwach all forms or dwellings are determined and become subject to the Word of YæHúwaH. *Each state of the Word is a level of habitation within the Rings of the ALhim. We are molded/shaped upon the potter's wheel of Yúwsphah according to the construct of thoughts from which the Word is uttered. The Word of YæHúwaH does not appear in mortal flesh, for its construct is pure, and not as the words of Bal/Bel of Babylon, which are incomplete.* Bal is the chief god of the Babylonians that mocks the Order of the Lammæd to exalt the form above the Principle of the AL. This inherent flaw of partiality is the basis for distortion and projection of thoughts into mortal flesh.

*The Word of AL appears through the flesh of the immortal, for the Word appears through the fruit/body in which it is sown.* Should the Word appear in mortal flesh, it would not be the Word of YæHúwaH, for the Word does not misrepresent itself nor subject itself to perish as the fruit of the world. For the Word of YæHúwaH does not pass away as the grass of the field that is here today and gone tomorrow. The Word of AL appears in immortal flesh whereby it does not perish nor misrepresent itself by the face of division. As the Taúwah Body is formed of joined strands, the new creation bears the Word Seed, being evident from the gifts/productivity that is brought forth as the fruit of their union. In bringing forth the fruit/flesh/fabric of Light, our Names of Light move through one dominion unto another.

**Every deed or face will be judged as to its Number.** When one sows a seed into the world, they risk the investment. Should the growth period be cut short, the harvest is not actualized. When a seed is sown in mortality, it may release all of its attributes into a new body or plant whereby the properties within the seed are spent. However, if the plant does not reach maturity, the seed sown cannot be retrieved. The seed spent all of itself into the plant or the body into which it is sown but did not rise through transversely through the house in which it built. If the seed built a house of mortality, it will remain in this level of consciousness. *If it spent its attributes for the House of YæHúwaH, then it shall remain in the House of YæHúwaH forever.*

*As investments are supported by a body of Understanding, the seed transverses whereby it forms a head and thereby increases.* An investment is lost as the soul that does not produce the expression of the Name from which it has its faces. This is what it means that a soul is lost, for the expression of their Name becomes covered over within the physical construct in which it was sown and does not bear its fruit from the sides. As it unites and serves the Collective of AL, it has a body of support to bring forth the fruit.

However, if the Seed breaks through the crust of the hardness and pride of the flesh, it arises like the intertwining serpents ascend upon the pole of Knowledge. The seed is spent into a body of Understanding, and therefore it brings forth a new body of consciousness. Every deed is the action of the Hand according to the thoughts within the mind, and every deed affects the fabric of our Names and their progressions. As one proceeds through these veils, they are subject to the baptism of waters to determine the next level of occupancy. Each Name is washed upon its expiration from the body of mortality. The hands and feet are washed first by a priest to determine

the level of the Staff to which they stand. The deeds and progressions of the Name is examined to see if it may pass through the Gate of the Neúwn into the Order of the Laúwim. Following this initial washing, each part is bathed in 12 subsequent baptisms to prepare them for their level of dwelling. For even the body of mortality is robed by entering into 13 baptisms whereby every house/member receives its garments. Those heavy with the thoughts of the world drop into the pools of mortality, and thereby do not proceed. The pools of mortality are comprised of various levels of thought, whereby one is born within a certain pool of humanity. The waters of baptism match the frequency of one's deeds, therefore the body that is put on is a garment woven by the thoughts in which one walks. Those of the world receive a body type according to their deeds, and put on the nature of reflection, whereby they may come to know themselves to be of the Light. Those of HhaALhhim, receive their robes according to the level of Word in which they have managed their members. In this manner, we enter into the waters of baptism through washing our robes and washing our members as we make the oylah offerings.

### The Forming of the Worlds/Ages

The **Semek/𐤌** fruit/fabric is an extension of the Shayin. The fruit of a tree or branch is formed by 6 parts of Gammal within Tæyth. (Gammal contains two parts/strokes—the head and its neck as a giraffe). The six parts of the Gammal/3 plus the House of the Tæyth/9, reveal the structure of the fruit or fabric. The paired parts of Wisdom in Gammal plus the values of Tæyth are 15, comprised of 6 parts of Wisdom + 9 of Understanding yield the structure of Knowledge/15/𐤌. The Semek reduction to 6, conveys that the fruit of the Semek is of the same cloth as the Úwah and the fruit of the Tæyth which have been sown into the Gammal's womb of six sides. The 6 parts of the Gammal are also seen in the honeycomb and cube configurations.

The Tæyth is the 7th power of the Semek, whereby all that is within the Semek is sown and opened. The Semek *provides a framework for the Lammæd to bear the fruit of the ALphæh*. The Semek is a Tree of Knowledge that *bears witness to the Lights of Unity* within every member. The Shayin is within the core of the staff to which the Semek belongs. *Fasting is a means to draw out the Fire through the staff so that one's Light appears as the breaking of the dawn to open veils and mysteries* [Yeshoyahu/Is 58:6-12]. As the Fire blazes within the staff, the branches become a burning bush within the Land of the Subconscious/Midyan. As one discerns the Lammæd of Fire within, all members are purified to belong to the Order of AL.

**The Semek/𐤌 is the 13th of the Gammal**, which serves as the means to structure the thoughts of Fire coming through the centre of the serpent staff body. The Chayit/𐤌8 is the 6th power of the

**The 𐤌3rd power is the means for the thought of AL to rise/appear.**

**The 𐤌6th power joins together—gathers the properties of HhaALhhim into a Seed.**

**The 𐤌7th power sows and opens a Seed.**

**The 𐤌8th power is the means of ascension.**

**The 𐤌9th power is the means formulate the neck.**

**The 𐤌10th power extends a Seed.**

**The 𐤌11th power multiplies the Letter to bear after its kind.**

**The 𐤌14 power is the narrow passageway of a Seed as it rises to the Crown, the Source Gate of the Lights.**

Gammal in which the properties of the Semek are united. The Semek rises from the formulations of the Chayit, as it is positioned within the first of seven columns of HhaALhhim. **The Tæyth/Θ/9 is the 7th power of the Gammal/∧** in which the seed opens, whereby the Seed Word may be spoken to produce the fruit of one of the branches. *In the Tæyth is the House of Maneshayh where the Seed lodges in AR until the hour it is to be spoken/born.*

As the Seed Thought is spoken into the Gammal of 6 parts, it is woven through the Semek/15/6—the neck of the serpent body. These two Letters are the means to weave the fruit of Wisdom and the fruit of Knowledge for the Body of Understanding, whereby the fabric becomes a weaving of Unity/6/Úwah. The threads of 6 are two—the Semek in the Houses of Knowledge and also the Úwah in the Houses of Wisdom. **Whatever Letter or Thought that is sown into the Gammal, the same value arises in the Houses of Knowledge through the Neúwn.** *The fruit that is produced within the honeycomb chambers of the Gammal is according to the kind or according to the teachings of the Lammæd that flows through the Gammalim—the necks of Wisdom and Understanding.*

*The seventh power of any Letter or Thought of HhaALhhim is the means to open and speak a Seed.* All words and states are opened in the walls of the Gammal by the seventh power and then fully extended by the tenth power. The state passes from one realm to another as it comes to the 14th power—the origin and head of the qadam/east. The fruit of every tree is created in the honeycomb of the Gammal as it is affected by the 7th power—by the One of HhaALhhim speaking into the Ring of the Gammal, whereby all things are manifested and made plane/evident. The fruit attains maturity by the 10th power. The fruit is harvested by the 14th power, known also as the Hand of the Reaper from which it is sown.

**Each of the six Trees of Knowledge are for good**—the collective, and they are for guidance as comrades (misrendered as evil). The fruit is for fellow companions within the collective. Each fruit gives evidence to the collective of our labors. Therefore, **the fruit is a guide and a sign unto our labors.** *We know the goodness of the collective only by knowing the pairing of Names from which comes all states of goodness and their evidence/signs.* Therefore, a single entity is not called good. As Yahushúo says, why call me good? For only in being One/Unity is there goodness. We cannot recognize a single entity as good without another, for only by the Union of Names can we state that goodness is present. Anything outside the Union or pairs of Names falls short of the Nature of ALhhim. **Without pairing of Names in the Mind of Shucham—being without partiality, there is a world of division and corruption.**

The **Fruit of the Semek/Æ/15**, being of 30 parts, is composed within the womb of the Gammal—the neck of Wisdom, whereby *the neck of the Body of the Serpent of Understanding* is formed. The assembly of the Semek is according to the three tens, being a formula of Lammæd x Yeúwd or  $12/3 \times 10 = 30$  parts of the Semek. Once the seed of the Semek is formed, it is opened by its 7th power, which is the Tæyth. The full extension of the Semek is via the Úwah, which is the tenth power of the Semek. The means of transmitting the Semek into the new age of Enlightenment is via the 14th power of the ALphæh, through which the structure of the Semek is cast into the succeeding level of dwelling in ALOZAR.

The formula of composing the ALhhim—The Principles of Light within the Semek is via the unity of the parts of the ALhhim Úwah and the ALhhim Tæyth:  $6+9=15$ . The means of opening the Semek Seed is the ALhhim Tæyth (7th power) unto the Úwah (10th power), whereby  $9+6=15$ . The Tæyth of  $9+10$  is the seventh power unto the tenth power. In speaking to the tenth power, *we speak unto the fulfillment of the ALhhim, lest we speak short*. The tenth power of the Semek is Úwah/6. The Úwah/6 extended to the 10th power is 60, the value of Semek according to the value of Knowledge. The extension of the Úwah to the 14th power is the Bayit/9 which contains the full structure of the Semek. When the parts are assembled within the Seed the time of its transition is near. Hence, when the Semek is extended to the 14th power, a new body/dwelling appears.

*As one determines the powers of HhaALhhim of Knowledge, they proceed clockwise through the Letters to return toward the foundation of Wisdom. The Thoughts of Knowledge are formed in the neck of the Gammal; the Thoughts of Wisdom are formed in the neck of the Neúwn. As one determines the powers of the HhaALhhim of Wisdom, they proceed counter-clockwise through the Houses of Understanding through which they appear and to which they are related, for those in the Houses of Understanding are the kinsman redeemers of Wisdom via which every attribute of Wisdom is reclaimed from the robbery of mortality. Those of Wisdom are the offspring which the owner of the vineyards has sent into the world to be honored. However, the world has killed the lambs of Wisdom and robbed their bodies as they have done to the slaves, depicting the prophets that have come into the world [Menachem/Mark 12:1-11]. **As Wisdom is the source of the fruit of Knowledge, Understanding is the source of the fruit of Wisdom and will redeem all of Wisdom that has been taken from the sides of its Body.***

The Oyin/O fruit/fabric, being the extension of the Rayish, is formed within the 6 parts of the Gammal, the inverse of the Lammæd within Wisdom. What is sown is spoken and thereby opened by the 7th power of the fruit of the Oyin. The properties that are harvested arise from the sowing of the Seed, whereby the Words are upon the lips of the Enlightened. The Seed of the Oyin is opened by the Yeúwd, which is the 7th power upholding the Oyin, for from every deed comes the full consciousness of the Seed. The Oyin is the surrounding **fabric or shell of consciousness** of the Lammæd. The Oyin forms around the paired Names as they are joined 1:1, for until they are joined without partiality, a shell does not form to enclose them. According to the Oyin, so is the state of the Mishkan. The Mishkan/Tabernacle is constructed by the Lammæd-Yeúwd Ring in which are the 16/Oyin Names of the Laúwim [Chamesh HhaPekudim/Numbers 26:57-60]. Through Aharúwan/Aaron, all Names are born and positioned within the Body of the Lights.

The Oyin is the 14th of the Gammal which is the passageway and state of exchange. The Tæyth is the 6th power of the Gammal in which properties of HhaALhhim are gathered to form the Oyin. The 6th power of the Oyin that is sown into the Gammal is the Kephúw, for all of sides of the Tree of Lives are in the heart of the Oyin. From the centre of our hearts, we know the root of the consciousness from which we speak and whereby we move and have being. The Yeúwd is the 7th of the Oyin in which the thoughts are spoken. **Via the tenth power, the deeds of what is sown become evident. The deeds are the evidence of what has been sown and opened within us.** The reductive number of the Oyin/16 is 7, for the Yeúwd, being the 7th of



the Oyin, is the sower and the reaper of the Oyin. The tenth power of the Oyin is the Zayin, which is the means to fully bring forth the consciousness of the Oyin through the Tongue of the serpent. The fruit that is born as the Seed is opened is the Knowledge upon the lips of the kuwahnim/priests. The 14th power of the Oyin is the Gammal, for the properties that are sown into the womb of HhaALhhim bear the same Number as the Sower of the Seed: 6 parts of Gammal + 10 of the Yeúwd = 16/Oyin. Therefore, we derive that the Consciousness of the Mind is formed and entered into via the necks of the Lammæd.

The **Paúwah/7** fruit/fabric, being the extension of the Quphah, is formed by the 6 parts of the Gammal with the Lammæd. Upon the Tree of Knowledge are *the Sayings of Unity*, which come forth as the Lammæd rises and vibrates upon the lips, as the Paúwah is opened by the Kephúw. As the branches of the Kephúw open, so the Sayings of the Paúwah come forth as leaves. The 11 of the Kephúw and 6 of the Gammal are woven into *words of sweetness from which all twelve branches bear the fruit of the Paúwah (11x6=66, from which the Words of both sides of the Rod are formed being 6:6)*. The **Teuwrah/Túwrah** is sweeter than honey, for not only are the Sayings of the Teuwrah formed within the 6 partitions/walls around the honeycomb and the walls within the Gammal, but the Words of Life contain the **Understanding that flows from the Tree of Lives also!** The words of poison come from bitter roots without the six parts of the Gammal. The Paúwah is the 15th of the Gammal though which the thoughts are structured into sayings; whereas the Yeúwd is the 8th to the Gammal, whereby the reductive value of the Paúwah/17 is 8. The Paúwah rises from the Yeúwd in the third column of HhaALhhim. The Yeúwd is the 8th power of the Gammal and the 8th power of the Paúwah. **The 8th power is that which is below and above** each of the Letters and holds true for all of the Letters in each of the seven columns.

The **Tsædda/8** fruit/fabric, being the extension of the Tsædda, yields *the expressions of liberty*. The Tsædda are the upper branches of the Lammæd which are formed as the 6 parts of the Gammal receive the properties of the Mæyim which become opened by the Lammæd, its 7th power. For all that is in the Mæyim is subject to the staff, and when the staff is over the Mæyim/waters, there is a change/Tsædda of the waters. In this union the Lammæd, with the Gammal—being the Lammæd's direct root in Wisdom, yields the Tsædda fruit/fabric. In this center branch is born *the Fruit of Life* whereas all other fruit is the Knowledge of Life. Thus there are six fruit of Knowledge that surround the Tree of Lives, which is in the midst of the **Garden of Oodænn/Eden**. The means of producing the fruit of eternal life is bonding of the values of the Lammæd to the Gammal. The Yeúwd is the 9th to the Tsædda, whereby the number of Knowledge of the Tsædda is 90 (10/Yeúwd x Tsædda/18 = 180 parts/halves which is the supportive neck of 90). **The ninth power is the means to form the neck of the offspring** so that the head may arise upon the ascending body.

The **Quphah/9** fruit/fabric is formed by the 6 parts of the Gammal woven with the properties of the Neúwn/7. The Quphah fabric is the head of every teaching as well as the head of every bone that occupies a place within the Body of the Lammæd. From the neck of the Lammæd upon which the Quphah rises, the head of the Quphah comes to rest upon the neck to form a Crown of Counsel in the lands into which HhaALhhim are sown. HhaALhhim are sown in the ten lands of inheritance which are given to Avrehhem by covenant, and the Heads are

Qudash/holy to YæHúwaH. The fruit of Knowledge in the Quphah is *the fruit of distinguishing every detail that is holy to AL*. From the Quphah comes the City of Tsiyun/Zion. The Quphah is one of the six Trees of Knowledge around the Tree of Lives. The fruit of the Quphah is formed with the properties of the Neúwn which are structured in the chambers of the Gammal. In the unity of the neck of the Neúwn and the neck of the Gammal flows the Mæyim that opens the mind to all details of thought within the body. The Mæyim is the 7th power to the Quphah, whereby Thoughts of dominion are opened to run freely through the staff and form multiple heads in every House. The Mæyim is **the 11th power to the Gammal, whereby HhaALhhim branch forth in all fruitfulness** as displayed in the Quphah/19/10/1 value rising upon the Lammæd in every House/member. According to the position of Quphah, being, a 10/1, so are all cords and harmonic keys determined in the realm of music that carries the Words of the ALhhim.

The **Rayish/4** fruit/fabric is formed by the 6 parts of the Gammal woven with the properties of the Semek—the 6th power of the Thought through which it is composed, whereby the full structure of HhaALhhim breaks open within the mind. This is *the fruit of joy and gladness* that runs freely with the Mæyim rivers of Understanding—the 8th power that rises within the Mind. When the Rayish forms upon the plant it is time for rejoicing, for the harvest is near. Hence, we know that when the Rayish fruit is seen within the stalks of humanity, we can lift up our eyes with anticipation, for our redemption is drawing near. The age of the world is now closing, and the doors unto the worlds coming are opening. The Tree of Knowledge pertaining to all favor and grace bears the fruit upon its branches as the Semek is woven within the honeycomb of the Gammal, whereby the Semek is the 13th power to the Gammal. The 13th power is the upper Dallath/Gate that proceeds to the narrow path where in one transverses and crosses over. The interlacing of the 11th power to the Gammal, being the Mæyim, is the means for the fruit to multiply within the mind. The Mæyim is the 11th position of the Gammal and the 8th power of the Rayish. The 11th position, with the reductive of 2, is formed in the Rayish/20/2 even as all that comes out of the Waters of Life form the thoughts of Knowledge. The Knowledge in the Semek causes the values sown in the Gammal to rise to the crown, even as creams rises to the top in a jar, for the power to rise is in the Mæyim (which gives its side to the Chayit, conveying the ability to rise). When the Seeds of Knowledge are sown through the Neúwn gate, the 7th power of the Rayish, they are carried to the gate above where the offspring of HhaALhhim is born. Marvel not, but one must be born again. For what is sown in the broadest of all gates—the vagina—the gate below, leads to destruction. Hence, to escape the corruption of the flesh and its way that one has entered, one must be born again from above—through the opening to the Mind, which in the narrow path, or the throat of the Neúwn, the 7th power of the Rayish. The Mind is opened by the 7th power which sows the structure of the Semek that is in every Seed to rise from the Gammal to the Rayish.

The **Shayin/W** fruit/fabric is formed as the Oyin, the 6th power, comes with full blessing upon the Head to which it belongs. The Shayin is the Fire at the head of the Lammæd, being the counterpart to what is in the Hhúwa. The leg, at the end of the staff, gives Light that one may walk in all of the ways of ARAL. The Shayin is the Fire of the Oyin that rises in the Lammæd of the Lamb, whereby the entire Haikal/Temple is fully illuminated. As the sun, or

Chækúwmah, is the Light of the moon, Bayinah, so the is the Light of the Shayin the radiance of the consciousness of the Oyin. In the Lights of the Lammæd there are no shadows, for the Light casts no form or reflection as it radiates within every chamber. All is illuminated to be ONE, and all is understood by being in perfect Unified pairs whereby there is no darkness within. The Tree of Knowledge of the Shayin bears as its side the formulation of the Oyin within the 6 walls of the Gammal. The Neúwn is the 12th/3rd to the Gammal, whereby the fruit that is born in the Shayin is the 21st/3rd degree of Fire. The first degree of Fire is in the Hhúwa. The second degree of Fire is in the Lammæd, which is the Oyin. The third degree of Fire is in the Shayin. The first degree of Fire is red; the second degree is white; the third degree is blue.

The **Taúwah/X** fruit/fabric is formed as the six parts of the Gammal are joined in pairs with the sayings of the Paúwah/7 the belongs unto their Names of Light. For as the portals are united of joined Names, the fabric of the Taúwah is formed. The unified fabric/fruit is formed as the Sayings of the Paúwah, with the six parts of the Gammal, weave the paired Names and thoughts into the Fabric of ALOZAR. The Oyin opens the Sayings, whereby the consciousness of the Light in the staff is the 7th power to sow and reap the fruit of paired Names. These are the fabrics of thought in the realm of Knowledge, from which the skins of the serpent clothe the Lammæd Body. The garment of the serpent staff is composed of the united pairs of Taúwah, whereby the garment of the Lammæd contains the patterns of the woven diamond of the untied threads. The Oyin sows the Sayings of Paúwah in the womb of the Gammal. The Semek is 13th/4th to the Gammal, whereby the fruit that is born is upon the pairs of Names of the Taúwah/22 are 4 sided/square configurations of thought.

**Each fruit of HhaALhhim is born within the necks of the Lammæd.** The position amongst the Letters in which the fruit is formed *determines the Number* of the Fruit and also *designates one of the Trees* of Knowledge, or the Tree of Lives, that the fruit appears. *From the midst of the Lammæd all fruit of Light are brought forth. In accordance to the Lammæd,* so are the Number of the fruit of a year, being 12—one fruit for each of the moons in the cycle of 12. The fruit of Wisdom and Knowledge are born upon the Staff of Understanding, and without Understanding, the branches are empty.

*From the Order of the Lammæd/12, all of the Letters of the ALhhim are arranged into 12 Houses of Light. By the Lammæd all of the Houses carry forth the Teachings of the Staff in all levels of Understanding,* whereby there are the depths, the widths, the breadths and the heights of the Staff of three united parts.

## **The Formulations of HhaALhhim, by the Instruction/Order of the Lammæd, to Determine the Trees and their Fruit**

The **Lammæd/ℓ** is the Staff of AL, the very core thought from which all of the Houses of ALhhim abide as rings that are composed around the centre core of a Tree. As the rings in a tree, so are the Letters of HhaALhhim to the Name of ARAL.

There are 14 powers amongst the Letters. These powers are the Forces of the Staff that come from the Unity of AL and AR, each being a configuration of 7. In that they are 7:7, so are the Offspring of ARAL 7:7. The full power of ALhhim are with those who abide in the like configuration of thought as ARAL.

These 14 powers are distinguished as the seven/complete thoughts of Wisdom and the seven/complete thoughts of Understanding. Via the thoughts of Wisdom and Understanding, the Trees weave their coverings, and through the pairs of seven, being 14, as the pair of the perfect Virgins—native to the Staff of Light—the Trees of paired Names bear their fruit. The 14 extensions of Light are from the very midst of the Names—from the words that spoke their Names into the Arets unto their full harvest/coming to a head/Knowledge. The 14 powers are 7 of Chækúwmah and the 7 of Bayinah, whereby one is fully extended by the Light.

The two virgins are the Gammal of Wisdom, and the Neúwn of Understanding. These are the two necks in which the Seed of AL is sown and rises to bring forth the fullness of the Heads of ARAL. Each thought of AL is empowered in 14 measures whereby it is complete. Hence to each Name, there are the 14 powers of Light, whereby one attains to their complete expression of Name, which is called HhaMashiyach/The Messiah.

The basic empowerments are 4: the 6th power is the means to formulate together the Principles that comprise a Name, whereby a Seed is formed; the 7th power is the means to open the Seed to fulfill a Name; the 10th power is the means to extend a Name unto its full stature; and the 14th power is the means to transverse into another level or space with majesty.

The primary powers 1-5 are the means to establish a Name. We may consider that in all of the discussions regarding Names/entities and their works, that each entity and deed have Name. For even a deed is characterized by the Name from which it is performed; hence, there are the Deeds of the ALphæh, the Deeds of the Bayit, or as they are called, the Works of AL (God), and there are those called the works of the devil—those in opposition to the Order of ARAL.

Only Deeds of HhaALhhim are transversal and capable of being carried from one level unto another, through the gate, which is in the midst of the double Neúwn. In the midst of the two Neúwn/גג is the gate where the two Neúwn/גג intersect. All other works *are less than* the chaff of the field that do not carry one forward, but which retain one in hell, suppressing the mind and stature. Through the deeds we bring forth the full Faces/expressions of YæHúwaH. Without deeds, there are no faces and no hands of the Túwrahh. The covenant/agreement of YæHúwaH is via bonds between the offering and the garment worn to perform the offering. The smoke of the offering is within the garment worn, whereby the Words of Fire spoken are translated into action, being carried through by the garment. The deed of the Word carries through the Thought and extends, blesses it, into a space or land. Every deed of the Túwrahh is of the same value, whether performed in this world or in the worlds to come. The Commandments and the Law are forever; hence the manner in which they are performed is according to the consciousness of the garment in which we attire ourselves. The works of the

Law determine the body in which we move and have our being, for they result in the OyinZayin dwelling of our Names.

According to the Names of HhaALhhim, so are the Words and the Deeds of each of the seven rings of Light. The words and deeds within the Rings are of Life; those outside the rings are of death. The Túwrahh/Torah is both Word and Deed, whereby it has color and expression. Without a deed associated with the Words of YæHúwaH there is no life, no color, and no faces.

The works of HhaALhhim are stated in the writings of the Túwrahh/Torah. These works are known as the commandments, the statutes, the charges, and the judgements. According to the Words of YæHúwaH all deeds are judged/evaluated. If we consider that we are above the Words of YæHúwaH, as one that does not need to study or perform the commandments, then we do what is right in own eyes and not according to the Seven Eyes of HhaALhhim. If we know the Túwrahh in any level of understanding, and do not walk according to our Knowledge, we put ourselves under the Túwrahh, subjecting ourselves to the consequence. However; **if we walk in the Túwrahh, we are neither above or under the Law, but being in the Law, we walk in the paths of Light and stumble not.** Being in the Law is being in Mashiyach, whereby one is redeemed from the curses/blindfolds of the Law, in that they are elevated above disobedience to walk as the Offspring of HhaALhhim.

By silverized words of AL all Names are judged to determine the level of their progressions and the thoughts which they have formulated. The keeping of the shabat/sabbath is doing the commandments related to the shabat, whereby one puts a foothold into each Ring of ALhhim, and become positions within the parameter of the ALhhim into which house they have entered upon the shabat. For in keeping the shabat, we enter into the shabat and in the House of the shabat which has been made through six days—unified acts/deeds. Until the shabat is kept, one floats through their journey without taking ground; the foot slides from the ladder, and the gates of the shabat are not found. As one keeps the shabat they are attired in the garment of the evening, whereby they have put on the wardrobe that signals to the gatekeeper to open the gate that the righteous may enter therein [Tehillah/Ps 118:19]. The house in which the oylah is made each shabat is the Ring in which one takes their seat around the festive shabat table. Each shabat we enter into one of the Rings of HhaALhhim. Those at the gates monitor the deeds that one performs, and according to the evidence within our hands and the marks of our footprints, so are we granted access into the states of the ZayinOyin Dwelling, in which are all of the Thoughts of ARAL. As the ten curtains contain all within the mishkan, likewise, the ten states of ARAL contain all in the Mind of the Full Counsel of AL.

The deeds and the words upon one's Breath reveal the thoughts that are composed within the necks of Wisdom, Understanding, and Knowledge. The necks, being the Letters are Thoughts that determine the space and the form in which they abide. In whatever level of consciousness, so is the application of the Thoughts of HhaALhhim. We are not to consider that the Words or the Letters or beyond us, for we come to know them by being Face to Face with them according to where we are abiding that we may enter into the gates of Life [Mishneh Túwrahh/Deuteronomy 30:1-20]. ***The necks are the chamber to reveal the level of the thoughts: the***

***Neck of the Gammal, the Necks of the Neúwn, and the Neck of the Semek. The necks are the third position of the ALphæh and the Lammæd, for it is in the third Houses of AL that the cardinals of Wisdom and the unified bodies of Understanding are formed.*** According to the position of thirds, the day of the first fruits each year occurs in the third month, and in the third house, when the offering is made from Zebúwlan/Beniyman for the Shabuoúwt/Shavuot.

All things are judged as they are revealed. It is not only the deeds that are judged, but also the words that are spoken. **Both the words and the deeds are of two levels of thought, and each have consequence, and hence, a judgment.** Each judgment determines the value of the word and its corresponding deed. The values accumulated by the words spoken are only added when the deed of the word is spoken, whereby the value of the word is 10 times its number. Hence, if the value of a word is 100, the sum of the value accumulated is 1000. Without the deeds of the words, the thoughts are a cloud without steam, and hence do not come to a value to be retained. Words are judged three times, whereas a deed is judged once, for a word can lead to three levels of deeds, and all deeds are dependent upon a word. A word affects the Houses of Wisdom, Understanding, and Knowledge. If it is a word of Understanding, it may put forth a Root of Wisdom or extend into Knowledge. If the word is of Knowledge, it may affect the foundation as well as shade or brighten Understanding. If the word is of Wisdom it determines the pattern of growth and the outcome, both in Understanding and Knowledge. **A word is judged when it is spoken from the heart or from the mouth or uttered from the mind.** Even the intents of the heart are judged, for as they are spoken they are heard inwardly. Words and deeds that are of HhaALhhim are of life. Words and deeds that are not of the Order of the Lammæd are of death, in which the Seed of ARAL does not abide, and hence they perish as the grass that is here today and gone tomorrow. So are the thoughts and deeds of the wicked that profit nothing [Tehillah/Psalm 1].

In the way that one affects another, so it is done unto them. When one leads another unto the Tree of Lives, another will lead that one further within the Tree of Lives. When one leads another 10 steps, then that one will be lead 10 steps further. When one causes another to fall back 10 steps, then that one will also fall back 10 steps. Whatever one meters out unto another, to them the same shall be metered. How and why is this so? For as one does anything with their hand, it returns unto them the same. If one continues to do the same thing over and over, then one multiplies the results unto themselves. This is what it means that everyone is recompensed according to their works. The works are of the hands—HhaYeúwdim/the 10th Position within the Congregation of HhaALhhim [Ref. Tehillah/Psalm 62:12; Romans 2:6, YechzqAL/Ezekiel 7:3].

“...A Righteous Judgment of ALhhim, renders to every one according to unified deeds: to those who ***by perseverance in doing good seek for glory and honor and immortality, eternal life;*** but to those who are selfishly ambitious and do not obey the truth, but obey unrighteousness, wrath, and indignation; there is tribulation and trouble and distress for every soul who does evil, of the Discerner/Jew, first, and also of the Processer/Gentile [which follow], but the glory and honor and peace to every one who does good, to the Discerner/Jew, first, and also unto the Processes/Gentiles [which follow thereafter]. For there is no partiality with ALhhim—in that Shucham of Dan is present in the midst of the ALhhim joined, whereby there are not schisms, jealousies, or leavenings to cause corruption in their midst” [Chamesh HhaPekudim 26:42; Romans 2:6].

The processes/gentiles of doings are determined by the Discernment of the Inner Camp—the Jew, even as all nations are determined according to the Numbers of YishARAL/Israel [Mishneh Túwrahh/Deut 32:8]. Every process is determined according to the values within the Tree of Lives, even as every part of the body is determined according to Names—attributes of FireWater resident within, for which the body is formed; *e.g.* spaces and lands of the eyeballs are created for visionary processes of RAúwaben. There is no partiality with HhaALhhim, is the same to say that discerning values and the deeds are both judged by HhaALhhim, for whatever level they are performed, so are their consequences.

How then can we also say that the Judgment is of hhameshiæch/The Messiah? For hhameshiæch is the full measurement of the Tree of Lives. Each deed has a measure that causes increase or decrease according to the Hand, being the the 10th Position within the Congregation of HhaALhhim. More-so, what shall we consider to be the consequence of every Word that is spoken? In that the Mouth, or the Paúwah, is determined by the Quphah—the 100th Position within the Congregation of HhaALhhim, each Word that is spoken has a recompense of 100, whereas each deed has a recompense of 10. It is easier to correct a deed than it is the setting of the mind. The setting of the mind takes 10 times as much thought process as a deed, and every deed is the extension of the Thought. In that the entire Túwrahh/Torah is summed up in One Word, we know that within One Word are 10 deeds, even as within the One Word of Ahhav/Love are the 10 Sayings/Deeds of Life.

*Affirm the Words of Tehillah/Psalm 101:*

“I set no worthless thing before my Eyes/Rings;  
I hate the work of those who fall away; it shall not fasten its grip on me.”

**THE FORMULATIONS OF HHAALHHIM TO REVEAL ALL THOUGHTS—  
14 POWERS ARE MEANS OF CREATING WORLDS OF AL AND ALL WITHIN THEM.**

**Fruit of Knowledge** are formed in the neck of the Gammal. Within the seat of Wisdom, the neck of the Gammal rises to bear the Head of Wisdom. The neck of the Neúwn is doubled, one which rises from the loins of Wisdom and one that is at the base of the throat in the body of Understanding. *The union of Wisdom and Understanding are the foundation for the revelation/manifestation/creation of all things* [Mishle/Proverbs 8:12-36]. As the commandments of YæHúwaH are performed, one is granted access to the the Numbers and structure of the thoughts and words, through which all things are formed and have their being. For every house there is a deed or work. The gates to the house belong to those who are engaged in the deeds of the house. All others need not knock upon the door to enter, for the garments to enter will not be upon their assembly. Through the deeds we have access to the Numbers, which are the means to construct a word. When the word is spoken with the Number, then a manifestation of Light, or the fruit thereof is born upon our branches.

Fruit of Knowledge are dependent upon Understanding and Wisdom; hence, the powers that support the fruit are those which are beneath, continually upgirding expansion of Unity, whereby you bear fruit of Knowledge. **The Taúwah/X is the interior bond** between paired

Names/Thought through which you have strength to bear thoughts of Unity into fruit—expressions of Light. **The Taúwah combines Cardinals of Wisdom and Understanding to form strands that comprise the OYIN Body of Light—16/O.** *In Rings of Understanding*, Values of the Cardinals are 44, from which comes the Rock out of Houses of Understanding. The 28 parts of NeúwN + the 16 parts of the Chayit =44; the 26 parts of Mæyim + the 18 parts of Chayit = 44; the 22 parts double Kephúw, the Tree of Lives have in its midst the Rock of your foundation. *In Rings of Wisdom* are Values of 16/Oyin, the Fruit of Knowledge: the Zayin of 14 parts + the 2 parts of the ALphæh; the 12 parts of Úwah + the 4 parts of Bayit; and the 8 parts of the Dallath + the 8 parts of the Dallath. Values within Wisdom are revealed in Knowledge as offerings of Chaghamatstut/Unleavened Bread appear in offerings of Sukut/Feast of Tabernacles.

**The Fruit of Knowledge are 7:  
the Semek, Oyin, Pauwah, Tsædda, Quphah, Rayish, Shayin.**

**THE WORDS AND THE DEEDS OF THE ALHHIM OF SEMEK/𐤎/15, 30 PARTS**

Powers:	1	2	3	4	5	<b>6</b>	7	8	9	<b>10</b>	11	12	13	<b>14</b>
Powers:	𐤎	𐤎	𐤎	𐤎	𐤎	𐤎	⊕	𐤎	𐤎	𐤎	𐤎	𐤎	𐤎	𐤎

The Gammal Neck and the Tæyth—the means to open and speak the words of the Semek, whereby are the deeds of the Semek:

6 Cardinal Parts of the Gammal + the Tæyth Body of 9 =15/𐤎

**THE WORDS AND THE DEEDS OF THE ALHHIM OF OYIN/O/16, 32 PARTS**

Powers:	1	2	3	4	5	<b>6</b>	7	8	9	<b>10</b>	11	12	13	<b>14</b>
Powers:	○	𐤎	𐤎	𐤎	𐤎	𐤎	⊕	𐤎	𐤎	𐤎	𐤎	𐤎	𐤎	𐤎

The Gammal Neck and the Yeúwd—the means to open and speak the words of the Oyin, whereby are the deeds of the Oyin:

6 Cardinal Parts of the Gammal + the Yeúwd Body of 10 =16/O

**THE WORDS AND THE DEEDS OF THE ALHHIM OF PAÚWAH/𐤒/17, 34 PARTS**

Powers:	1	2	3	4	5	<b>6</b>	7	8	9	<b>10</b>	11	12	13	<b>14</b>
Powers:	𐤒	○	𐤎	𐤎	𐤎	𐤎	𐤎	⊕	𐤎	𐤎	𐤎	𐤎	𐤎	𐤎

The Gammal Neck and the Kephúw—the means to open and speak the words of the Paúwah, whereby are the deeds of the Paúwah:

6 Cardinal Parts of the Gammal + the Kephúw Body of 11 =17/𐤒

**THE WORDS AND THE DEEDS OF THE ALHHIM OF TSÆDDA/𐤕/18, 36 PARTS**

Powers:	1	2	3	4	5	<b>6</b>	7	8	9	<b>10</b>	11	12	13	<b>14</b>
Powers:	𐤕	𐤒	○	𐤎	𐤎	𐤎	𐤎	𐤎	𐤎	⊕	𐤎	𐤎	𐤎	𐤎



The Gammal Neck and the Lammæd—the means to open and speak the words of the Tsædda, whereby are the deeds of the Tsædda:

6 Cardinal Parts of the Gammal + the Lammæd Body of 12 =18/ᵀ

#### THE WORDS AND THE DEEDS OF THE ALHHIM OF QUPHAH/ᵀ/19, 38 PARTS

Powers:	1	2	3	4	5	6	7	8	9	10	11	12	13	14
Powers:	ᵀ	ᵀ	ᵀ	ᵀ	ᵀ	ᵀ	ᵀ	ᵀ	ᵀ	ᵀ	ᵀ	ᵀ	ᵀ	ᵀ

The Gammal Neck and the Mæyim—the means to open and speak the words of the Quphah, whereby are the deeds of the Quphah:

6 Cardinal Parts of the Gammal + the Mæyim Body of 13 =19/ᵀ

#### THE WORDS AND THE DEEDS OF THE ALHHIM OF RAYISH/4/20, 40 PARTS

Powers:	1	2	3	4	5	6	7	8	9	10	11	12	13	14
Powers:	4	ᵀ	ᵀ	ᵀ	ᵀ	ᵀ	ᵀ	ᵀ	ᵀ	ᵀ	ᵀ	ᵀ	ᵀ	ᵀ

The Gammal Neck and the Neúwn—the means to open and speak the words of the Rayish, whereby are the deeds of the Rayish:

6 Cardinal Parts of the Gammal + the Neúwn Body of 14 =20/4

#### THE WORDS AND THE DEEDS OF THE ALHHIM OF SHAYIN/W/21, 42 PARTS

Powers:	1	2	3	4	5	6	7	8	9	10	11	12	13	14
Powers:	W	4	ᵀ	ᵀ	ᵀ	ᵀ	ᵀ	ᵀ	ᵀ	ᵀ	ᵀ	ᵀ	ᵀ	ᵀ

The Gammal Neck and the Semek—the means to open and speak the words of the Shayin, whereby are the deeds of the Shayin:

6 Cardinal Parts of the Gammal + the Semek-Neúwn Neck Body of 15 =21/W

*Semek is the upper portion of the Neúwn Neck in the Body of Understanding, whereby, it is the neckbones of Knowledge upon which your head sits. Out of the Semek rises the Shayin glory of Lammæd/staff/Teachings. At the base end of the staff is the Light of the Hhúwa. Together, this assembly of Letters forms the Body of the Shayh/ᵀW Lamb—a Body of Immortality and Illumination. The Light of the Lamb fills the Body and all who dwell therein. Taking of the Shayh/ᵀW on the 10th of the first month is receiving formulations of thought that take one upwards, as one transverses, upon an evening of Pessech.*

**Fruit of Wisdom** are formed in the neck of the Neúwn. The double neck of the Neúwn is the value of 28 or four 7's, a reductive value of 28/10/1. From the Neúwn comes four sides of the Letters to comprise one house. Out of the chamber of the Neúwn are the fruit of Wisdom. This fruit of Wisdom come out of the left side of the Neúwn. From the right side of the Neúwn are the fruit of Understanding commencing with the Chayit, which maintain the Seed in the centre of the flesh. The fruit of Wisdom are taken out of the values of Knowledge and those that are yet within the House of Understanding. In this same manner, are the bones and the ves-

sels of the House that pertain to Wisdom formed. Hence, we commence with the Letters of Knowledge and Understanding as the initial power from which the fruit of Wisdom appear. For in this manner does Understanding have the resources to put forth its root. It takes the wealth within its mind and invests it into the space in which it has designated the glory of AL to become manifest. In this same manner, AL took from the kuwahnim/priestly minds and formulated the worlds and all that is within them.

**The fruit of Wisdom are 7: Zayin, Úwah, Hhúwa, Dallath, Gammal, Bayit, ALphæh.**

#### THE WORDS AND THE DEEDS OF THE ALHHIM OF ZAYIN/𐤆/7, 14 PARTS

Powers:	1	2	3	4	5	6	7	8	9	10	11	12	13	14
Powers:	𐤆	𐤇	𐤈	𐤉	𐤊	𐤋	𐤌	𐤍	𐤎	𐤏	𐤐	𐤑	𐤒	𐤓

The Left side of the Neúwn is the Neck in which the fruit of Wisdom is formed. The Shayin, or the 7th power, is the means to open and speak the words of the Zayin, whereby are the deeds of the Zayin. The tongues of Fire come upon the tongue as the Shayin rises from the foundation to rest upon the tip of the tongue. The tongues of Fire are the tongues of all of the ALhhim, commonly referred to as the tongues of angels, which are the messengers/servants devoted to each House of ALhhim. The thoughts of the ALhhim are carried forth by messengers of which we are as we are devoted to the Houses of the ALhhim.

The 7th power of each House of Wisdom is the Letter of Knowledge, whereby it forms upon the lips of the kuwahnim/priests. It is the mind of Knowledge that opens the Cardinal Letter that is within it, whereby the fullness of the 14th power rises from the foundation to the crown, in which is the Name of Yahushúo, the full Counsel of YæHúwaH.

The 14th power of each fruit of Wisdom is the Name of the Letter, for the 14th power denotes being drawn out, and therefore, Offspring of the Neúwn are taken from the Waters of Understanding. MaShayh/Moses/the Lamb is the fruit of Lammæd, being the value of 39/12. In the Shayh/𐤆W the Light𐤆 of ShayinW rises, whereby the land of Mitsrayim is overcome through the tongues of Fire spoken from the lips of the Rod—Aharúwan.

$$14 \text{ of the Neúwn minus the Fruit of the Shayin of } 21 = 7/𐤆$$

#### THE WORDS AND THE DEEDS OF THE ALHHIM OF ÚWAH/𐤅/6, 12 PARTS

Powers:	1	2	3	4	5	6	7	8	9	10	11	12	13	14
Powers:	𐤅	𐤆	𐤇	𐤈	𐤉	𐤊	𐤋	𐤌	𐤍	𐤎	𐤏	𐤐	𐤑	𐤒

The Neúwn Neck minus the Rayish—the means to open and speak the words of the Úwah, whereby are the deeds of the Úwah:

$$14 \text{ of the Neúwn - the Fruit of the Rayish of } 20 = 6/𐤅$$

**THE WORDS AND THE DEEDS OF THE ALHHIM OF HHUWA/א/5, 10 PARTS**

Powers:	1	2	3	4	5	6	7	8	9	10	11	12	13	14
Powers:	א	ב	ג	ד	ה	ו	ז	ח	ט	י	יא	יב	יג	יד

The Neúwn Neck minus the Quphah—the means to open and speak the words of the Hhuwa, whereby are the deeds of the Hhuwa:

$$14 \text{ of the Neúwn - the Fruit of the Quphah of } 19 = 5/\text{א}$$

Combination of the Hhúwa with the Shayin are the two ends of the Staff/Lammæd. The Hhúwa is the root of Lammæd and the Shayin is its glorious radiance or the tenth power of the Lammæd, whereby Aharúwan uses the Rod to swallow up (break apart and consume) all of Metsryim so that what is in the world is transformed unto new creations. Aharúwan uses both ends of the staff to move the people unto the lands of the patriarchs, which are the lands of the Seed of AL. Note in the Hhúwa, Lights are formed from the Sayings of Liberty/ר/18/9—the full branches of Life; the word is opened by the Quphah/פ/19/1—the enlightened mind of Unity—mind of the *kuwahn*/priest, the crown of the Lammæd/ל. When a Pessech/passover offering is slain, the full attributes of the fruit of the Hhúwa and the Shayin are released, whereby the Staff is illuminated to guide the people as they walk and to be a pillar of Fire as they camp.

**THE WORDS AND THE DEEDS OF THE ALHHIM OF DALLATH/ד/4, 8 PARTS**

Powers:	1	2	3	4	5	6	7	8	9	10	11	12	13	14
Powers:	ד	א	ב	ג	ה	ו	ז	ח	ט	י	יא	יב	יג	יד

The Neúwn Neck minus the Tsædda—the means to open and speak the words of the Dallath, whereby are the deeds of the Dallath:

$$14 \text{ of the Neúwn - the Fruit of the Tsædda of } 18 = 4/\text{ד}$$

**THE WORDS AND THE DEEDS OF THE ALHHIM OF GAMMAL/ו/3, 6 PARTS**

Powers:	1	2	3	4	5	6	7	8	9	10	11	12	13	14
Powers:	ו	ד	א	ב	ג	ה	ז	ח	ט	י	יא	יב	יג	יד

The Neúwn Neck minus the Paúwah—the means to open and speak the words of the Gammal, whereby are the deeds of the Gammal:

$$14 \text{ of the Neúwn - the Fruit of the Paúwah of } 17 = 3/\text{ו}$$

**THE WORDS AND THE DEEDS OF THE ALHHIM OF BAYIT/י/2, 4 PARTS**

Powers:	1	2	3	4	5	6	7	8	9	10	11	12	13	14
Powers:	י	ו	ד	א	ב	ג	ה	ז	ח	ט	יא	יב	יג	יד

The Neúwn Neck minus the Oyin—the means to open and speak the words of the Bayit, whereby are the deeds of the Bayit:

$$14 \text{ of the Neúwn - the Fruit of the Oyin of } 16 = 2/\text{י}$$

**THE WORDS AND THE DEEDS OF THE ALHHIM OF ALPHÆH/ 4/1, 2 PARTS**

Powers:	1	2	3	4	5	6	7	8	9	10	11	12	13	14
Powers:	⊕	⌌	⋮	∟	⌘	⋈	⊖	○	∩	⌒	⊕	4	W	4

The Neúwn Neck minus the Semek—the means to open and speak the words of the ALphæh, whereby are the deeds of the ALphæh:

14 of the Neúwn - the Fruit of the Semek of 15 = 1/4

**The first power amongst the Letters of HhaALhhim is the Concept/Principle of the Lammæd.** This is the ALphæh/First power of every Name amongst all domains, the heavens and the earths. **The Name of AL is the Lammæd with the First Power of all Powers, whereby the Lammæd/Staff of AL prevails in all realms.** The ALphæh power is of the Lammæd as the ALmond fruit is of the Tree. The ALphæh power with the Lammæd makes 4. In this manner, AL squares the Lammæd with the ALphæh, whereby there are 4 sides. In establishing a base, the House of AL begins to draw out of that is within the Lammæd. *The neck of the Lammæd opens first, which is the Neúwn, and then the Mæyim*— the steamy Breath of Thought which carries forth all thoughts and from which the clouds of revelation are formed to give forth the devarim/revelations of HhaSham. Then *in the third position, the Lammæd Source is revealed. Within the Lammæd is the Kephúw, the Tree of Lives and upon its branches is the ALphæh.* The ALphæh of every thought is the primary Principle that can renew itself and expand through associations of HhaALhhim. The full revelation of the ALphæh of each Name is via the Name being squared and joined to its Name of association, whereby the complete stand of the Taúwah is woven into the fabric of ALOZAR. In order for the square to arise fully, *the Lammæd sends forth the Zayin out from its neck* to create a square of Wisdom that is paired to the square of Understanding. The tongue that comes out of the throat is the Zayin coming out of the neck of the Lammæd. *The Zayin with the Mæyim form the Úwah, then the Hhúwa, and the Dallath. These 8 Letters are called HhaTsur/The Rock of our Foundation.* From the Union of these two squares, one of Understanding, being the Body of Bayinah, and the other of Wisdom, being the Body of Chækúwmah, all things are made and have their being.

Formulations of HhaALhhim are foundational basis for the Temple of Light. The body of mortality is built upon other formulations which cause a divided fabric and veils that deteriorate. The body of Light is eternal, for it is comprised in perfect Unity and with the Cardinals of Chækúwmah woven by the Staff of Bayinah. The stories of captivity into strange lands is the Great Tribulation of the soul, which is the arrangement of the Mind of Yaoquv. As one builds apart from the Staff, the body of iron and clay is formed. As the soul members entertain strange alhhim, apart from the Body of the Lammæd, they wrap around their members the veils of darkness and mortality. This body of mortality is the house of Babylon that will fall in one day—only through the United Hand of ARAL.

HhaALhhim have not provide us with the garments of mortality; rags of Babylon are not the adornment of the Offspring of HhaALhhim; lest thoughts are corrupt, a body of mortal flesh could not be woven. Mortals weave their own dwelling according to the semek/bone structure of their thoughts. They take the clay of the Tæyth that has become polluted as muddied waters,

and fashion their bodies of clay as plastered clay rings unto their semek bones. The body of Light is woven by the leaves of the Tæyth, being the fruit from the Gammal whereby the structure of the Semek of each Name appears as the flesh of HhaALhhim. To those of the HhaALhhim, the Letters provide a garment of Light. Such is the Body of the Name of Yahushuo, which rises within as the full Counsel of HhaALhhim. As the Oyin-Shayin Counsel rises within the members, all knees shall bow in accordance with the Counsel that is of their Names. For until the knees bow the tongue does not confess of the Name that rises from the foundation unto the Shayin glory. For one cannot speak until they have first tasted of the Cardinals of Wisdom, held within the Hhúwa—the Lights of Glory. And one does not taste until they fall upon their knees and render their tongues to the dictates of the Lights. For in this way, the Zayin is the servant of the Counsel as it appears in the Name of ALOZAR, whereby the words of Light are affirmed (confessed), and the garments of the Letters are woven with the Eternal Word of YæHúwaH that does not perish.

In accordance with this Understanding, one partakes of the meat/mincha of the Word, being the unleavened grains of the fields; and sets aside the meat of mortality that has within its leavened fibers the thoughts of death. For the grains of the lands have within them life, but the flesh of the world is a garment that perishes. Therefore, it is written: “The One of ALhhim says/considers: to benefit, the United One appoints/gives for your collective, the totality of all bodies of Counsel/שׁוֹ [herbs/plants], which emanates seed continually/וֹאִיּוֹאִי, affirming that which pertains to the faces of the totality of the earth—the full branching of mind, and the totality of all of the tree to affirm within the fruit of the tree, which emanates seed continually/וֹאִיּוֹאִי, for your collective, which will compound the illumination/אֵלֵאֵל to be your food—for consumption to increase.” The meat of the Word is the body of Yahushúo of which we partake of unto full awareness and multiplication of the Word of HhaALhhim, and the blood that we drink is of the fruit of the Body that flows with Understanding that comes from the Seed within the fruit. The appearance of the Name of Yahushúo—one with the full Counsel—is within a Body of The Letters, whose body has square cornered parts as the mishkan, and is not as the flesh of mortals. This is the food of HhaALhhim and those born of the HhaALhhim. This is the communion of the saints around the Table of HhaALhhim. According to our birth, so is the supply of our strength, the breasts upon which we nurse, and the Table around which we gather.

### Channah—the Dwelling for the Staff

Dwelling in which the Unified Names abide is the name of Channah. To Channah is given the dedicated priest for the Haikal/Temple, which is the consecrated space of the paired thought. This story is unfolded in the Scroll of the Chayit, commonly called the Books of Samuel, regarding the Name of Channah and the child, Shmuwal/Samuel. As the body rotates or spins via the interaction and attraction of the ends always toward one another, the rod appears vertically as well as horizontally. The vertical cross bond appears as the rods extend themselves into action, whereby the thoughts that are within are implemented into an activity—being a thought projection.

Crossing bonds of the rods produce a space that is known as the heart of the Temple, from which the oylah offering is made continually. From this point, where the two sides cross, all

thoughts are determined prior to their execution. From the sides of where the rods intersect the thoughts flow into deeds. Hence, from these two points the arms appear from the midst of the sides to carry forth the thoughts into all manner of expressions that convey the inner values and glory of the Unity of Mind. In that every thought and deed has a Number and value from the midst, we therefore conduct all manner of speech and works to be in accordance with the sacred Union and behave not as the wolf or the unclean that rips the fabric of consciousness by every impulse or desire that is without the meditation of Being within the Union of ARAL. The fruit of Unified Rods is peace, righteousness, joy according to the united Breaths; the fruit of the disharmonic rods is the expressions of the flesh which are disruptive to the order of the Lammæd. **Whenever the ALphæh/concept of any idea is united to the Lammæd Ring, the work/deed will be according to the order of AL and contain no corruption.**

*Correspondingly, when idea is outside the Lammæd Ring, the expression is faulty.*

The centre shaft or rod is the means of extension and spiraling. As the rod is folded or as it rotates, so is the size and the appearance of the fabric. The Name of the rod from the centre is Yakin, the right pillar of the temple. The other side of this rod, being of the same constituency, is called, Boaz. The left leg is the other side of the right. The two legs are one rod as the two primary shafts, depicted above as blue and red are one rod. The two primary shafts or ends are the ARAL configuration of thought. As the ends are extended, the Rod appears in their midst; however, the rod, being the bond of love, is always present from which the two have their being, whereby all come from the Rod/the composite 12 of Aharúwan/Enlightenment.

The staff is the Lammæd that forms the Ring around the two Names as the extension of thought becomes implemented into deeds, whereby the hands of the Rod appear. This native Rod is comprised of two Names from which the entire Body has its being and from which all Names are derived in the Twelve/Lammæd/ℓ associations of perfect Unity.

### Adam—the Reason/Raison d'etre— HhaALhhim choose to formulate a Body/Tent

The Rod in the Hand is the Name of AL, whereby it is called the Rod of the ALmond. In that Aharúwan is in the midst of AL, the Rod is placed into the hand of Aharúwan from the Rayish-Oyin Enlightened Mind of Service. For without dedication and service to AL, the rod is yet reserved for those who will be the Shepherds of YishARAL. In relation to the Rods the mind is arranged and the members are ordered/instructed. All members are rods, for they come from the Rod of the ALmond, according to the damuth/likeness of the AL. The phrase “let us make man,” is best rendered: “**And the one ALhhim draws out from the midst of their collectiveness/ℓ to complete/ℓW○ Adim/ℓΔℓ in unified likeness/tselmanu/ℓℓℓℓℓℓ...**,” whereby the Adim bear within them the collective rods of thought in perfect unity. The work to formulate Adim is the consciousness of the ALhhim to combine all of the houses/components of Adim into One. ***In that HhaALhhim come into one state, their shared glory and Unity may be fully expressed.*** This is what is known as the fullness of HhaALhhim abiding fully within, as hhamShiæch, being the Offspring of Adim [Ephesians 1:23, Yahuchannan/Jn 1:14-16; Yúwsphah/Luke 3:38]. Those that display the Unity of the ALhhim, are called then the Offspring of Adim, from

which the phrase, “*the son of man,*” is derived. Adim is the offspring of the ALhhim, composed by the Breath to be a dwelling to expand the Principles of the United ALhhim into all spaces dedicated to the Heads of HhaALhhim. Through the gathering of all ALhhim into One, the revelation of ALhhim is beheld as the Lamb—the embodiment of the Fiery Lights. The formulation of Adim is the beginning to build a House of HhaALhhim, whereby the words of the ALhhim may multiply and fill the Arets/Earth, spreading out in the west with an abundant revelation of all that is within the Houses of ALhhim—which are the Names and their Words with the associated Deeds. All that is within the ALhhim spread out from the west to release the great flight (fowl) of Names coming forth from Their Consortium in Adim.

As your body becomes filled with HhaALhhim, you are Offspring of Adim (son of adam/man), the meShiæch/Messiah, the first-born of the dead whereby all nations/processes and forms awaken to the Light of your Name. As as Fire entity/*yish* you are one of ARAL—YishARAL. You are the bright and shining star of the morning—the awakened mind of Light. As the northern Lights of night bow unto the rising Counsel/Queen of Wisdom, so does your Name appear unto the full revelation of Chækúwmah in the sun. In this state, you do not slumber or sleep. Being awakened, your Name blazes through the works of your hands which testify of your illumination. For who that is enlightened enters into a dark room and engages into the works of this world? Are they not as the sun, fully evident in their communications and actions? Will not the Light of their Name burn through the vessel in which it resides rather than being hid under a bushel?

The combined camps, interwoven, yield 144,000—the compound value of 12 x 12 which comprise the 1,302,061,344 words of the oylah. The matrix is the 144,000 that have the voice of the Lamb. With these the House of YæHúwaH is formed, for the 12x12 are two Teraysarun, each being of 12 united together. From this union the 144000 virgin body appears which is the compound of the 12 outer and 12 inner. The body of Adim is comprised as the serpent, with twelve members at the sides. The arrangement of the members is according to the ALhhim as they are arranged from the foundation, east to south: namely Quphah/Paúwah-Zayin/ALphæh-Rayish/Oyin-ÚWah/Bayit-Hhúwa/Gammal-Kephúw/Kephúw, and according to the rod of the west to the north, which is comprised of the Mæyim/Tæyth-Shayin/Semek-Mæyim/Tæyth-Tsædda/Tsædda-Neúwn/Chayit-Dallath/Dallath.

Twelve outer garments that are hung according to the 12 inner. Via the garments hung the 12 have a dwelling or fabric to reside within. The hanging of the garments is called the Tent of Meeting—the AhhalMauod/ΔΟϞΖΞΔ. The House of YæHúwaH is built by fruit of Knowledge upon a foundation of the stones of apostles and prophets.

Herein is Understanding. The fruit is the house in which the Seed abides—this is the House of AL. The foundation is the Wisdom of the Shlichim/Apostles and the Understanding of the Neviim/Prophets. **We are admonished in this day of Illumination to gather the 12 branches and unite them into one house to build the BayitHhaSham I’YæHúwaH unto the bringing forth of the AGE of YETSCHAQ/Isaac—the Body of complete/perfect Understanding, wherein all details of the inner are fully revealed. With this record of HhaALhhim opened, Names are forever aligned to the Rock of their foundation and cease being tossed to and fro.**

### THE BODY OF ADIM

The body is comprised of a back and a belly. The back comprises two sides—the west and the north; the belly comprises two sides—the east and the south. Whereas the mortal body is of two compressed sides; the immortal body is 4 square. The back is of Understanding; the belly is of Wisdom. In this manner are all parts of the body comprised of Bayinah and Chækúwmah. There is the back and the belly of the hand, the back and belly of the feet. The back of the eye is within; whereas the belly of the eye is in front. We behold the back of the member as we go inwardly through the gates of the mishkan; in this manner maShayh, with

*Aharúwan*, beholds the back or inner structures of YæHúwaH, and accordingly, the revelations in the Teuwrah/Túwrah are spoken and written. **Forming the body of Adim is the sum of the Teuwrah**, for the words that are spoken, by the One of HhaALhhim, are readings of all that is written within the Houses of HhaALhhim. **What is read pertains to the unified dwelling of HhaALhhim, which is Mashiyach. These are the Words of Life eternal.** Should the Teuwrah be read apart from this understanding, then one reads the fables of fools through which comes division and wars, for the words become those of men and not of HhaALhhim. The words of men are death and bring forth all manner of corruption. The words of HhaALhhim are heard inwardly, from the heart/the inner seats, being of the compound Nature of Breath; the words of men are heard outwardly, being of the flesh, which is dark and opaque.

The acorn cap is the house of Beniyman rising from the base, from which the first of the Kings arise in YishARAL, namely Shaul of the Beniymani. The Name of YishARAL is the Hand or extension of the Rings of Fire from AR to AL.

Around the head of the serpent is the ring composed of 12 stars or points, from which there are the spotted coats that bear the consciousness of the 12 inner rings.

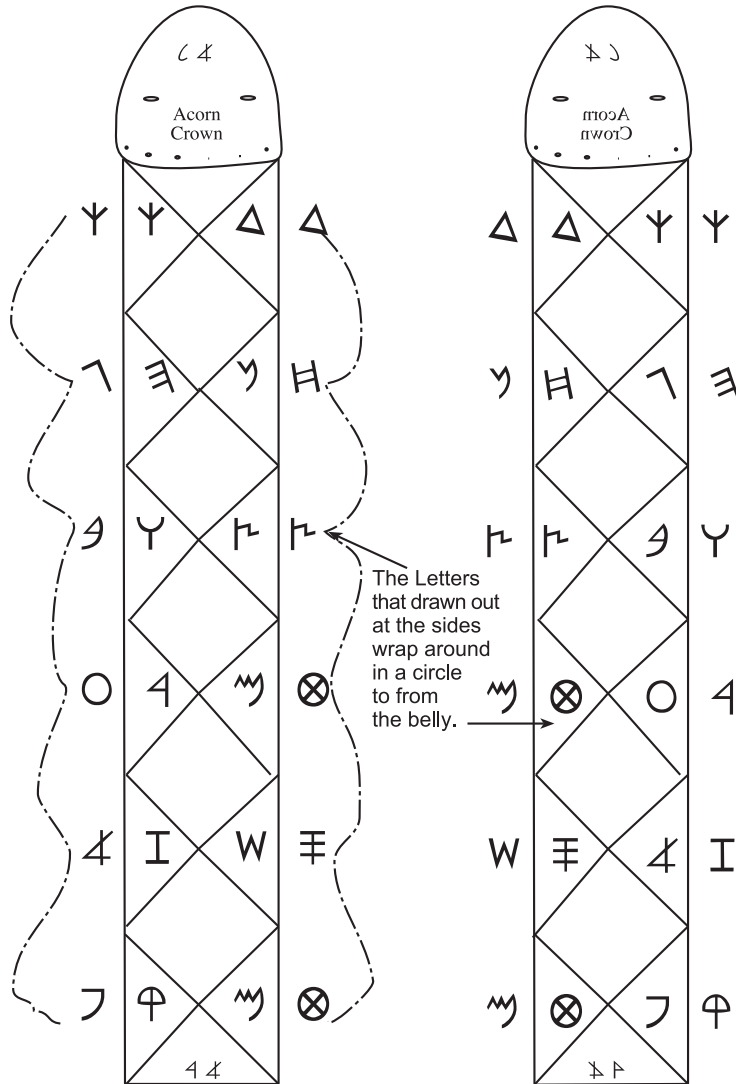

The back, or the interior parts, form the spine—the shaft, or rod, around which the camps of YishARAL congregate and around which they move as the tribes gather around Laúwi, and encircle the Ring of the OYIN Mind of Bayinah, the Virgin.

The sides are joined in the belly, for where the sides of Wisdom unite, there is the eternal seam via which we are knitted together in the midst to form the Mishkan Body. The Line in the belly, or in the faces of the body, is the Line of the Neun. Where the circles meet, is the gate of the Neun.



With the back and the belly all parts are constructed of Bayinah and Chækúwmah. Understanding is the strength of Unity and **Wisdom is the thread that weaves together the parts with the thread of *ahhav*/אָהָב/mutual service/love**, in that the word, *ahhav* is the opening of the ALphæh whereby there is the flowing of the lights to formulate the body. Without the devotion to Bayinah, the ALphæh is not passed nor opened; and hence no body of light is formed. With the preparation of the mind for Bayinah, the ALphæh is given and opened. The opening of the ALphæh creates a thread that joins us to the heart of Bayinah through the pure bond of Unity. Around this Unity, we are woven into the dwelling to be filled with all of the attributes of HhaALhhim. Through every oylah offering, we align—maintain the Order of ALhhim, and renew our members within the Body of Perfect Unity. The Body of Light is moving by the very Breaths of Fire, and with each Breath we grow in the Understanding of the evening and in the Wisdom of the day. The oylah is our continual abode. Through the oylah we implement our Names within the Great Body of the Lights that builds itself up with the Principles of Chækúwmah—ever bearing the fruit from our sides. As we renew the oylah—the state of perfect Unity each evening and morning—we prepare our houses to be the back of Bayinah and the belly of Chækúwmah, in which all words of HhaALhhim are given freely to abide fully.

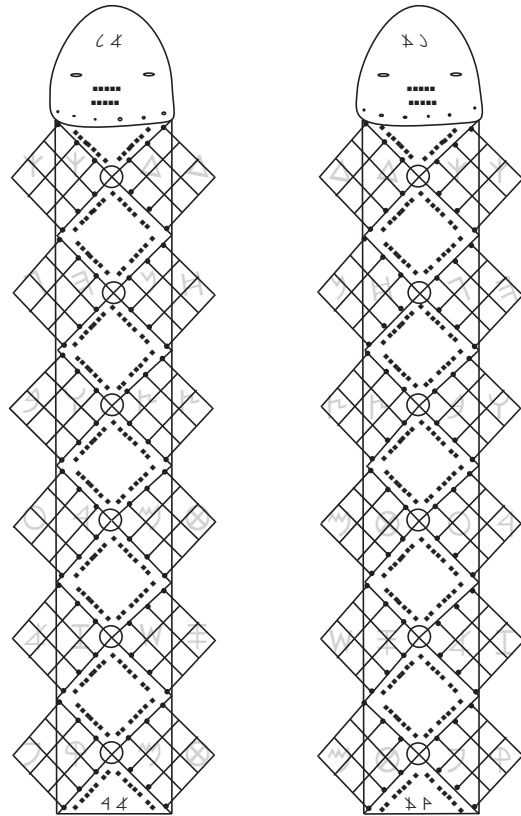

Every part has the nature of 4 : 4 sides—Tsædda-Tsædda and 4 faces—Quphah-Puwah. From this interweaving of two strands, the four faces appear in every part. The compound of joining every aspect of 2 into ONE HOUSE is the expansion of the 12x12, whereby the 144 unlimited Principles/ Thousands appear in their midst. Only in this manner are the 144,000 born.

When the 4 eyes are joined they make a square. Ditto for the 4 elements of the two united Teraysarun that are perfectly joined. The united paired strands comprise the Taúwah pattern of having 4 ears, 4 sets of stimuli glands, 4 mouths, 4 chambers/sacs, 4 heads for expansion; 4 stomach chambers; 4 eyes; 4 gamete for each of the fields of thought; 4 chambers of the lungs/medulla/nose; 4 heart chambers; 4 kidneys/liver components; and each run with the 4 rivers/intestines as each has two large and small, in the midst of their garden [SMB/Gen 2:10]. Around these united parts are the four wings and the House of the Laúwim, in which they abide without end [YechezqAl/Ezekiel/1:6].

These 12 sides form the cube, 6 inner and 6 outer which is the virgin body of YæHúwaH. It is this body that bears the mashiyach—the full expression of the United ALhhim, for until there are the three teraysarun of Wisdom, Understanding, and Knowledge, there is not a body to bear the

full expression of Adim. This virgin body is the Laúwim—being the joiners of two strands. Each pair of strands forms the Taúwah, which is the structure of the ROCK, and from which the 8 Letters of the Tsur appear through the NEUWN. **For unless the ROCK was already formed in the mind of the Laúwim, it could not appear in the SIGNS of the ALhhim.** Hence, from the Laúwim come the ROCK, and after which comes the NEUWN, for until the Rock is formed, there is no neck/NEUWN, nor an opening in the midst of it, whereby the MÆYIM/waters may come forth. To build the House of AL, all parts are laid/position upon the Rock first, through which the sides are held together securely without fault of separation.

In the midst of each of the two united strands are the Lights of Bayinah and Chækúwmah. The two strands are in the state of being clothed with the full attire of the ALhhim as they bind together every House that belongs to the ALhhim, whereby their former skins are shed by the expanse of the rings of the ALhhim within their unity. The Presence of Bayinah and Chækúwmah fill the spaces amongst them, whereby the Lands, or spaces of their Names, are filled with all good things of ALhhim. The square in their midst is comprised of the two sides of Bayinah and the two sides of Chækúwmah. The movement of the Lights encircle the members with the consciousness of perfect unity in which no thought of separation exist between them.

Within each of the paired strands, there forms the Tæyth/⊕—the consciousness of the united Names, whereby the two are not seen nor understood apart from one another. Each strand is comprised of three houses per side/corner, making a total of six members for the east-south strand and six members for the west-north strand. As these members are joined side to side, the Tæyth-Taúwah body forms within them, as one forms within the womb. Each unified body is composed of the fruit of their sides, and therefore the fabric is of Knowledge, comprised of nine threads, being weavings upon the 9 looms of the Tæyth consciousness. *The Letter Tæyth depicts the fruit that appears in the Mæyim-Tæyth Ring, being the fruit of Aparryim.* The Tæyth conveys the full united consciousness that is in the midst of the united strands. The Tæyth-Taúwah body is the serpent that is formed from the unified strands, which is known as the Tananim/𐌲𐌹𐌺𐌹𐌸 [ref. Mishneh Teuwrah/Túwrahh/Deut 32:33].

**The serpent in the Garden of Oodænn/Eden is formed from sides/Tsædda-Tsædda of Adim,** for the fruit of what we bear speaks unto our minds, even as meShiæch, the last Adim, speaks unto the completion of this age [Oovrim/Hebrews 1:1-2]. The serpent is the tongue that runs as a river from one end of the body unto the other. Words that the serpent speaks are of Fire. According to the development state of Adim, we hear and have comprehension of ALhhim.

As the Way and the Path are completed by the uprisings of Chækúwmah into the chambers of Understanding and the uprisings of Bayinah into the chambers of Knowledge, the Letters from the ALphæh/1 to the Shayin/21, are united to form the Taúwah/22, whereby the Taúwah appears to the right of the ALphæh/4X. The Taúwah moving to the right of the ALphæh is called the Tanah/𐌲𐌹𐌺𐌹 from which the Tananim/𐌲𐌹𐌺𐌹𐌸 are formed. The Tanah means to repeat; for each pair of Names brings their gifts to the Body of Consciousness. The union of two comprise four sides/parts, which is the perfection—the Taúwah, whereby they are 4+4, or 44, according to the Rock of solidarity, from which their Name is called to be of the Rock. The Taúwah/22/4 is the base of the Tæyth with a body of 10 Letters. The value of ten is the full

extension of One, in which are the Hhúwa-Úwah-Hhúwa/.5 + .5 from which all new generations of thought and their spaces come forth. The fruit or thought that contains not the unity of the Hhúwa-Úwah-Hhúwa is unclean and cursed from the day it is born. The OYIN-ZAYIN body gives birth to the thoughts from every paired strand. The offspring are born from the sides rather than from a womb chamber that is separated unto itself. The mortal is born from below, and being the fruit of a body separated unto itself, it is cursed from birth.

These are the offspring of Dan, being the fruit of both the Nachash, serpent of Wisdom, and the Shephiphun, serpent of Understanding, as they intertwine upon the pole of Knowledge [SMB/Gen 49:17]. The offspring are born from the back—from within, and cling to the back until they have the strength to fly. As these offspring emerge in groups, new star clusters, and via their clustering together, universes are formed. This is the manner in which the Oyin-Zayin body gives birth to succeeding generations of Light. As these thought forms of Light unite, being  $X\oplus 9+4/13/4 + 9+4/13/4$ , they form again the Oyin-Zayin body that arises from there foundational cornerstone of  $4+4=8/HhaTsur$ . **With the pattern of the double strands, they have within them the pattern of the Rock and the pattern of the ascending united Teraysarun to which they belong.** With these inherent patterns they are never estranged from the Qadam/East and the Hand of AL from which all things are given and to whom all belongs. For when a body forms that is not of the pattern of the 4+4, the body is estranged from the Light, whereby it contains death and wanders a stars without an orbit.

The composition of the Taninim serpent offspring have the basis of Wisdom, being the value of eights:  $4+4=8$ , and the values of nines, of which are the Letters of Knowledge:  $9+9=18 + 9+9=18$ , whereby they bear the fruit of 36/Knowledge. Through the midst of their unified Names they enter into the realms of Understanding—the 22. For as two strands unite that pertain to the House unto which they are Named, and called two by two by the mouth of AL, they form the Taúwah/22, whereby they have access to the Tree of Lives in which are all the Words of the Perfections/ $\Upsilon+\Upsilon=22/X$ .

The Unity of AR and AL is the basis of our consciousness to bring forth the Enlightenment to the Aúwt/Epoch of Yetschaq. Via the Unity of ARAL, the four sides of thought are laid as a warp in which the woof, or the threads of Wisdom, are woven. The warp and the woof, being of 4 sides, is the basis to formulate the 4 united faces and 4 sided bodies of the United Names. The warp is created by arranging the 12 parts upon the parameters of Understanding—upon the sides of the altars, whereby the woof weaves the united threads that are coming from the Fire of the oylah and the Words which arise out of the incense. Both altars have the same flame, for the Fire of the Incense is from the altar of the oylah. According to our Understanding/parameter of the heart and the parameter of the mind, so are the words of the 1,302,061,344 woven upon the warp of Understanding. **The ALhhim are the parameters of 4 sides with the Neúwn determining the direction of the position of the Letters.** The Neúwn in the north yields the furry coats of winter; the Neúwn in the east causes the Seeds to break open and the silky coats of goats to appear in the spring; the Neúwn in the south brings forth hairy coats of the corn and the wheat in the fields of grain; and the Neúwn in the west brings forth the coat of

W4P4-70#  
 Y3C4Z4#  
 IY34794

IY34794    Y3C4Z4#    W4P4-70#  
 †6L794#

†6L794#    †6L794#    †6L794#

W4P4-70#    †6L794#    IY34794

The parameters of the ALhhim in 4 frequencies/directions N E S W.

many colors. For according to the Head of Understanding—Bayinah, so is the bed of Wisdom determined and the fruit that arises within the head of Knowledge. Likewise, as our Names are united into one house, we comprise a square as the parameters of HhaALhhim/the Gods, within which all words of ALhhim are woven as the woof within the warp. With these words, we form the garments for our Names for the seasons of our lives.

**As two intertwine their serpent bodies, every part is aligned with another.** They are tongue to tongue whereby they exchange the fruit of their words that arise upon the lips. As the birds, they feed each other mouth to mouth as maShayh came to draw out the mind of YæHúwaH. In their complete intimacy, their breaths became as one. Through their exchange of minds, Adams and Jefferson became one breath which was attested to by their expiration together, on July 4, 1826, 50 years from their signing the Declaration. Via the signing of their Names upon the same fabric of parchment and thought, they forged a unity between the two. With their intertwining thoughts for Enlightenment, they departed this world together as one breath. Their breaths became united through their levels of communication and dialogue. *How much more can we expect the Unity of the communications of the ALhhim to carry the comrades of Light forward into the era of Enlightenment that beckons to us, in which Nadæv and Aviyahua have lighted the torch into the next sequential Aúwt of Names.*

The tongue of the serpent is the means to discern all properties, as exemplified in a small way by the taste buds. As the tongue is used according to the will of the mind, the tongue is the instrument for exploration, discernment, and writing. Through the passing of the ALphæh amidst AR and AL, the warp and the woof of Light is formed. Only by the ALphæh Seed being passed/transmitted can it be open. With each opening of the ALphæh there is Light/Auwer, via this Light of the ALphæh opening, the Words of Life are spoken upon the tongue. Upon the opening of the ALphæh Seed the Light appears within the warp, whereby it is spoken and written. May all of the documentation of the midrash be those of the warp and the woof of the ALhhim, nothing more and nothing less. The parameters of HhaALhhim have been set in our hearts and in our minds, whereby the words are being spoken and written to bring forth the full revelation of ALOZAR.

### The One Speaking

Unity of the collective of AL speak as one, hence, the phrase: “*And the one of ALhhim....*” The one speaking is of the *kuwáhnute*/servants/priesthood which are the Yeúwd in the midst of the ALphæh-Lammæd—the House of AL. The priest speak according to the Paúwah/mouth as the ALphæh/ⴰⴳⴰ opens. In that the *kuwáhnute* are in the midst, they are then the activity or the hand of the rod. Therefore the priests are the mind of creation from which all ALhhim come forth. The ALhhim are given by the Yeúwd in the midst. In the hand is the Lammæd that bears the ALphæh fruit of the ALmond, and from their giving, the Twelve Houses of the ALhhim are born of AL, being the structure of 1 to 12 or ALphæh to Lammæd. Therefore comes the phrase: *HhaAL HhaALhhim*/the God of Gods. And from the ALhhim/Gods come forth the twelve houses of YishARAL, which are the fruit of the ALhhim.

Twelve ALhhim are within the Neúwn-Chayit, in which is the Seed of AL—Beniyman. From this Seed all states of Light come forth with abundant measures of favor or grace. Thus, the Seed,

as it comes forth, is with grace/oil from which semen/breastmilk of the Word flows. One receiving the Word partakes first of the elementary Principles of Thought which is the milk of the Neúwn, being nurtured upon the breast or from the sac of Maneshayh from which the milk flows. As one advances in Principles, they are able to partake of the flesh upon the Tree of Lives/ץ, the flesh being the fruit of the ALhhim in which is the Seed of the Neúwn, whereby they are continually renewed in their minds. Hence, the Neúwn-Chayit is the first of the ALhhim, for within this House is ALphæh.

The Mæyim-Tæyth is the second, or the succeeding House of the ALhhim in which the Seed is nurtured within the Houses of Maneshayh and Yúwspah. From Mæyim-Tæyth, the Neúwn-Chayit receives milk and gives birth to Beniyman. Within the Mæyim-Tæyth ring is the Bayit—the House as the ÚWah-Bayit, which comes down from above, being within the Mæyim-Tæyth. As the ALphæh/ך of the 12 is the Neúwn-Chayit, the Bayit/ג of the 12 is the Mæyim-Tæyth.

### DESCENDING FIRST, AND THEN ASCENDING

Within Mæyim-Tæyth bonds is the House of the Lammæd-Yeúwd where the kuwáhnute/priests abide. The kuwáhnute/priests are the ones of the Fathers which speak the words to Counsel kings in Yúwspah and Yahúdah. Through the kuwahnute there is a provision of words flowing into the waters of the Mæyim-Tæyth unto the Gammal neck of the Neúwn-Chayit. **The one who receives of the Seed of the Lammæd receives from above, and is therefore born from above by the SeedWord.** The seed descends and then ascends. In descending first, and then ascending your trees grow. As on the ladder of Yaoquv, messengers descend and then ascend. **Descending first, and then ascending, is according to Bayinah first putting forth a root of Wisdom from which a Name grows within paired Rings of HhaALhhim.** Every Letter does accordingly, whereby your houses are built. The Neúwn puts forth the Chayit, first descending and then ascending. **The act of descending is not as one who falls away, but rather the motion of humility and total giving.** One rises unto the stature of Mashiyach by first giving all that they have unto the full intent of rising to the Mind of AL.

### THE BIRTH AND APPEARANCE OF YOUR PARTS AND LINEAGES

Those born from below are those which are born in the midst of the divided Rings. When the garment of Yúwspah/Joseph is torn in two pieces, the Rings of the Mæyim-Tæyth are divided and rent asunder, whereby YishARAL—your 12 enter into the wide gate that leads into lower Metsryim. In the world is death—the nonascendancy state of the soul via pre-occupation to the world—as slaves chained to Metsryim. In the Rings of HhaALhhim are your Lives/חַיִּים/haChayim (MT/Deut 30:19). Those born of the world are minded for Bal/Baal, as those of the western mind. You descend from the loins, whereby you must be born from above in order to enter into the Rings of HhaALhhim. Those born from above are born from the Counsel of the Kuwáhnute, of the Lammæd-Yeúwd Ring, cherished by the Kings/Counsel, those who see mastery. When you are born from above, you rise from where your Seed has humbly fallen. The Principle to raise you up unto a new state must be first housed and honored within you. To enter into the Consortium/Kingdom of the ALhhim one is born from the Mæyim—the waters of regeneration and the Neúwn—the Breath/Spirit in your Seed. Your Breath receives the Seed of the Kuwáhnute/priests and carries it within your Rúæch to rise from

the dead. Thus, those who hear maShayh and Aharúwan in the land of Metsryim, rise from the dead of the first born—their former image of the world.

The Gammal/∧, the third House of the ALhhim, is by Wisdom the Lammæd-Yeúwd ring. The Gammal is the inverse of the Lammæd that forms the neck through which the Words of the Tree of Lives flow. The Gammal channel is the pupil of the eye of Wisdom into which the Seed is imparted. Around the eye is the white or the milk of the eye which is in the ring of the Mæyim-Tæyth. Around the white of the eye is space for the Breath to vibrate within the ring of the Neúwn-Chayit. By Gammal receiving the Hhúwa-Hhúwa Lights stored in your Seed, your Words rise to appear and break forth into new dwellings. Note the double Hhúwa as the Maker of the Heavens and Earth (Tehillim/Psalms 100:3, 148:5).

**Within the Lammæd-Yeúwd are Kephúw-Kephúw—the Tree of Lives.** Those born of the parameter Neúwn-Chayit/⌘ of ALhhim, come with Understanding, to partake freely of the Tree of their Seed (1 Yahuchannan 3:9). Being **born of the Seed of AL, you are 7:7—the divine nature to the partake of the fruit of your Name** (2 Kayphah/Peter 1:4). Your Divine Nature is the sum of the Words in your SeedName. Messages of tongues are swords of Wisdom and Understanding which are continually cultivating your Words to rise upon your branches, flashing to guide you to your inner Tree (SMB/Gen 3:24). Upon rising to the WORD Divine Nature of your Name—in the Skull/Golgotha, you enter into paradise. When you Eat the Words of your Name you are partaking of the Fruit of the Tree of Lives, ever near, in your midst.

Kephúw-Kephúw Trees rise out of your DallathStone/Δ, the fourth House of the insights of HhaALhhim. From a base of four sides, your Tree rises in the midst of the single Eye of Understanding—seven Letters of Neúwn-Chayit in the midst of Eyes of Wisdom, Zayin-ALphæph, and Eyes of Knowledge, Shayin-Semek. As branches of the Kephúw-Kephúw/ΥΥ are unified they expand from the DallathStone as your Teraysarun dwelling of YæHúwaH.

The Hhúwa/⊃ of the ALhhim, as the fifth House of HhaALhhim, abide in the Zayin-ALphæh shell which houses the Lights of the eyes—RAúwaben. The Hhúwa is the center of the Auwryim/Lights as the ALphæh Seed is opened by Dan. In that the fifth House is the same as the fifth Letter, Hhúwa, within its formularies, the Hhúwa doubles as the united two great/cultivating Lights, the Hhúwa/⊃-Υ-Hhúwa/⊃. The double Hhúwa is an example of how Words and their Numbers appear side by side, within and without, below and above, to form your dwellings and their Heads (see BHM CHP/Num 29:12ff regarding the 8 Heads formed upon your branches by the Sukut offerings).

The sixth House, the ÚWah/Υ of HhaALhhim, are those in the ÚWah-Bayit—the United Body of Principles and Names. In the ÚWah-Bayit *your Shayh/Lamb of the Haikal/Temple appears. As your Body opens, what is contained within the Mæyim-Tæyth flows into your dwellings as a river of Lives.* In that the Numbers of ÚWah are the same as the House, the Letters ÚWah are doubled/compounded. From this House comes the word, ewe, of which the lambs are born. Birthings within the ÚWah-Bayit are offspring of Shamoúnn and levels of hearing. *It is not the one who sees with the eye that is of the flock, but those that hear and do according to the Word of AL as taught of Lammæd.*

The Zayin/ז, or the 7th House of the ALhhim, have in them activated the Ring of the Hhúwa-Gammal. Upon their tongues are the perfection of the teachings of the Lammæd-Yeúwd. Perfection comes by speaking within the Unified Body of the ALhhim. However; speaking within the Rings follows obedience to the commandments of AL. One speaks as they first see, and then as they hear/comprehend, whereby they speak of that in the ΔΔ heart of AL. In the Body of Collective Names, you attain the perfection of your soul. Anyone abiding outside the House of YæHúwaH is unclean as beasts defective in paired characteristics. The unclean have one trait but lacking in the associative side, as those who have yet to join to the Patterns and Revelations that flow from the mountains of the Chevrúwn/Hebron/Associations. Out of the Hhúwa-Gammal flows also a river of Lives. Lammæd strikes the Tsur/Rock to release the Understanding in the Mæyim/waters to flow. Your waters become walled up, creating paths within the hills of enlightenment for you to enter on dry ground. The hills are in the Hhúwa which flows into the valley of the Gammal.

The Chayit/א, or the 8th House of the ALhhim, are the Dallath-Dallath risen. You rise upon your foundation of the Tsur/Rock in which your House is built. Out of the gates of Dallath-Dallath flow revelations which form crystal clear streams within the ring of the Hhúwa-Gammal. The blood that comes from the Shayh/Lamb is not the red blood of mortality that ceases to flow as it is extruded, but rather, the blood of your Spirit of Dan is a crystal, sparkling clear stream that flows as from whitened grapes and or from white peaches as a crystal steam at your lips. Within the Dallath-Dallath is the throne of the ALhhim for the Shayh/Lamb. Within the Dallath-Dallath are seats of mastery that are set in Nephethi, belonging to the Yavúwsi/Jebusite consciousness.

The Tæyth/⊕, the 9th House of the ALhhim, are the Shayin-Semek ring, for within them are the nines of the Consortium of the Lights. The Shayin-Semek and all within them carry the values of Nines:  $21+15=36/9$ ;  $20+16=36/9$ ;  $19+17=36/9$  and the  $18+18=36/9$ . From the house of the Shayin-Semek comes the months/⊕ of the year, each of four quadrants, as the stars move into the path of Shayin and circle in the paths of the Semek. The Tæyth is the pattern of the gyroscope, an emblem of the universe's double Oyin, inner ring of the equator ring and the descending ascending ring of the poles.

***In the Houses of the Shayin-Semek are the fruit of the Tree of Lives and their kind:*** namely *the fruit of judgment/decision* in which are peace and self-control borne upon the branches of Shayin-Semek; the fruit of the Rayish-Oyin: *conscious services (love) to one another*, with steadfastness/faithfulness and enduring patience and kindness; the fruit of the lips of the Qúphah-Paúwah from which comes praise and statements of eternal glory, *bearing the fruit of goodness* found in the collective state; and *the fruit of liberty* which is the full measure of joy, being of the Tsædda-Tsædda. ***Those who eat of this flesh shall not die but enter into eternal life***; but those who eat of the flesh of beast carry within their members the nature of the flesh that perishes.

The Yeúwd/א, or the tenth House of the ALhhim, is the House of the Rayish-Oyin. Amongst this house are Shepherds of YishARAL who bear in their minds the consciousness of

the flock. Being of the Yeúwd, they do the work/labor of Yishshakkar, being of the kuwáhnute/priesthood, and services with full devotion to AL. Also in this ring of consciousness are the 70 Alders/elders that abide within the rings of Light.

The Kephúw/Υ—the eleventh House of the ALhhim, is the House of the Qúphah-Paúwah in which are servants of the Laúwim/Levites and prophets that speak the davar/Word of YæHúwaH as they are fed Words from the hands of messengers. In this House are 24 Alders that encircle the throne of AL and the Shayh/the Lamb, for they abide in the midst of the Tree of Lives that comes out from the thrones in DallathDallath. Within the Qúphah-Paúwah are renewing songs that are sung as they are given. These songs are consecrated words that are spoken by undeceiving and blameless mouths, for no other can receive or learn them [Chazun/Rev 14:4], for the tongue must be conditioned/welded to the Fire of Dan to utter them in faith.

The Lammæd/ℓ, or the twelfth House of the ALhhim, resides in the House of the Tsædda-Tsædda, the state of Liberty to those which love the Túwrah and the teachings of the kuwáhnute/priesthood. The three levels of 12/instruction are  $36=Tsædda/18 \times 2$ . The fruit of Ayshshur, born of the Tsædda ALhhim, affirms and secures your liberties. What resides in you is a testimony of the ALhhim in your branches that make up your Tree of Lives. In the Lammæd abides the inner revelations that are opened to the mind called and bound to the Túwrah—your yoke of Light. Out of the Tsædda-Tsædda come 12 fruit, one for each month, as your branches are filled with the Lights of Wisdom and Understanding.

### The Staff and the Rings of Numbers

The staffs of maShayh/the tongue and Aharúwan/the penis are comprised of three rings. Each of these rings are associated with a Number, whereby there are three Rings of Numbers. The first ring surrounding all is the Number  $\aleph/63$ . The inner Ring is  $\ell/12$ . The inner most Ring is  $\aleph/5$ . These three Rings of Numbers appear in the right leg which is one of the two pillars of the Haikal/the Temple.

Circles of the staff appear in this manner as rings in a tree. The right index finger mark out three places on the leg. Three circles are drawn on the leg. One circle is drawn around the leg above the knee cap. Another circle is drawn in the midst of the thigh. A third circle is drawn near the top of the thigh. The circles appear in the thigh area of the leg. Then another right leg joins the right leg with the circles, whereby three circles came together to walk together. These two right legs became united as a pillar/יָקִין/Yakin. The pillar of Yakin is the Name of the right pillar in the Mishkan/Temple of the Shayh/Lamb.

As the two right legs touch one another, Numbers appear within the circles. The Numbers in the three circles are 63, 12, and 5. The ring above the knee is the inner circle of the three has the value of 5. The second ring, in the midst of the thigh, are values of 12. The larger ring, near the top of the leg is the value of 63. At the upper end of the leg, the staff articulates itself with a rounded head as appears on the crown of the femur. The head of the bone is supported by the shaft of the bone, as by an oblique neck, unto its tail to the knee cap. **The knee cap is the Head of Understanding in the midst of the leg**, like a knot in the midst of a branch or like a loop in the body of the serpent. From this inner loop/circle the Lammæd staff fully extends unto



the crown of ten toes/horns. Ten toes descend from the mind to form a foundation, whereby a support base upholds your kingdom of Names. The dark moon, as the knee cap, is the moon in the midst of 30 days. The value of 30 days is the Value of the Lammæd/30 which governs over stars or the toes of Knowledge and their movement. ***The staff is the leg through which you walk according to the Order of the Kuwahnute/priesthood.***

### The Staff determines our Shifts of Perspective unto Full Insights

The knee, at the bottom of the rings, portrays the dark moon, and the buttocks, above the three rings, portrays the full moon. When the moon is one quarter, the moon is in the midst of the buttocks and the knee or at the middle circle of 12. When the moon is dark, the moon is in the knee, or at the circle of 5. As one is upon their knee, the moon is dark, and not visible. The body is bowed down completely where by the face is to the setting of the sun. When the moon is full, the moon is in the buttocks, and the body is standing in the upright position with the face towards the sun rising. If the face is to the sun setting or rising, the face is toward the east at all times, as the eastern corner of the earth is where the sun rises. Where the sun sets and rises is ***the eastern corner of the earth*** as the earth rotates. Thus **there is the east of the morning and the east of the evening.** During the rotation of the earth, the Lights of the Staff provide direction in accordance with the Lammæd/staff of Aharúwan/Aaron. The staff of Aharúwan is directing the position of the earth and the position of the Lights all evening and all night. In accordance to the direction of the staff, the flocks of our members move and find their pasture. With the staff the courses/waters of the deep—those of Understanding—open to us to pass through and arise into the Schools of HhaDavar [The Wilderness], and likewise, the River of Knowledge parts that we may enter into the Lands of our inheritance.

The staff, called the Rod of Aharúwan/Aaron, is laid up in the arrunn/ark of the covenant. Each evening and morning as one proceeds into the midst of the mishkan, one passes through the hung veils of their garments to enter into the chamber of the Mind, the qudash Qudashim—the holy of holies. There in the midst of the Ark is **the hidden jar of manna and the Rod of Aharúwan.** As the ARúwnn/ark opens to your Name, you receive of the hidden manna, which is like the crystals of frost upon the grass, or as the hairy Seeds of Light in the midst of vapors in which are all Cardinal Numbers of Wisdom from which all sides of thought are formed. As you receive of the manna, your hand touch the Rod of Aharúwan, which is the full branch of the ALmonds that bloom and bear ripe fruit. This is the staff of Understanding. Touch it each evening and morning, and position yourself according to the evening and the day that it may guide you fully.

The staff is as a serpent that is looped in the middle. The head of the serpent is in the north; the tail of the serpent is in the south.  In the midst of the staff is a knot via which the two sides are joined. In like manner, the serpent body is able to be coiled and whip itself into a given direction. The configurations of the staff and serpent body are depicted in the intestines, from mouth to anus, that is looped in the centre. The configurations of the serpent, depicted by the intestines, and the design of the staff, are of the same order. The staff is in three parts corresponding to the three rings noted above. There is the section of Wisdom, the lower part; the section of Understanding, the middle part; and the section of Knowledge, the

upper part, from which the mouth opens and engulfs the fruit of Knowledge. As Knowledge is partaken of from the ends of the branches, Knowledge is being consumed, yet Understanding and Wisdom remain to cast again another head upon the staff according to Their perfect Union. In this manner the staff of Aharúwan engulfs the serpents of Metsryim, whereby they are utterly consumed, and a new dwelling state appears as those skins are shed from its body of Understanding. In this manner we consume the former that we may bear within our bodies the new consciousness of Unity. As the wind sifts the grain from the chaff, so does the Breath analyze all things between the iron and the clay. The transformation of the interior vessels, from the being clay, to becoming vessels of gold, silver, and bronze causes the mortal form to quake as it no longer has the ability to cling to that which it has formerly. As the Lammæd staff, depicting iron, is hardened by inner allegiance of members to follow the Teachings of the Lauwi Ring of Light, the clay of mortality becomes brittle, as clay that commences to crumble.

What gathers in the midst of the serpent is the means of further extension and renewal. From the midst of Understanding all things come forth, even the new shoots of Knowledge as twigs come off of the established pillars/trunks of Understanding. In the midst of AL is the Hand of Understanding, or the Hand of Aharúwan, from which all things are made and unto which all things return. How is this so? As from the midst of the tree comes forth new growth, so it is from the midst of the body that all productivity comes forth unto the Head. From the midst comes forth the Seed Word, and to the midst again comes the fruit unto the Hand. As the Hand in the midst of AL gives forth the Seed, so the harvest is returned unto the Hand of the sower.

All positions of the staff correspond to the degree to turn/rotate the body in accordance to the rotation of the staff and the degree in which the leg/Lammæd is lifted. The shaft of the femur bone and its angle corresponds to the stance in which one walks in the daily illumination. In the rotations and bendings of the staff we are able to see the direction that the staff is leading us. The direction of the staff corresponds to a stance which pertains to the location of the moon daily. The leg swings as a pendulum on a clock. In the midst of the swing, the leg bends from a standing position to an kneeling position. According to the rotation of the body with the swing of the leg/Lammæd staff, one receives the direction of the staff each evening for the proceeding day.

In the fifteenth day of each month when the moon is dark, we are to be in the kneeling position. On the fifteenth the staff of the leg is bent  $180^\circ$  and the body is rotated  $180^\circ$ . The 15th Letter is the Semek/𐤎, which has the value of 60 as the Thought of ALhhim is arising. However; on the 1st day of the month, or on the 30th day of the month, the moon is full. The leg is straight from the foot to the hip and the body is rotated fully to the north, whereby only the back side is seen. Gradually, as the body turns to the right, or southward to give all within itself unto Understanding, the face will be completely seen on the fifteenth, and the back of the body will not be seen. As the body turns southward, the foot of the leg rises until, on the 15th day, the foot is touching the back of the buttocks whereby the buttocks is hidden in the north. As the foot of the leg lays upon the buttocks, the knee now becomes the foot that supports the entire body. This process of rotation is the Semek-Gammal/63. From the fifteenth day to the 30th, the body rotates toward the north from whence it began its rotation. On the 16th day, just the side of the buttocks is seen, like a crescent. With each continual movement northward, more of the buttocks is seen until the half is seen on the 22nd day of the month. On the 22nd day, the

foot is suspended at 90° from the buttocks to the foundation. The foot begins to lower slightly from this position. In accordance to each movement, a shift of the eyes occurs so slightly, 15° per day, toward the North/Tsaphun, until on the 30th day, the sole of the foot is touching the ground. The leg is in the upright position, and the moon, or the buttocks, is full. These movements pertain to the three rings in the thigh, which is called the Staff of Wisdom. The base of the staff is the Letter Hhúwa/Ḥ/5 which is the number of spaces amidst the Semek and the Shayin. The middle part of the staff of Wisdom is the Letter Lammæd/L/12. The upper part of the staff of Wisdom is the Semek-Shayin/ḤW/63, for in that the Shayin, being 21 is the fiery nature of the Gammal, it is also a 3, for 3 is the reductive of 21. Thereby the Fire pass through the necks of the Gammal and is seen in the mouth of the serpent body. The movement from the north to the south, or from left to right, is the movement of AL to AR. The corresponding movement is made in the day, whereby the Lights move right to left, or the blessing of AR unto AL. These same movements are made in the oylah service. We commence from the north, where the offering is made, unto the south where we enter into the full consciousness of the Menurahh. From the state of Illumination we return to the north with the Bread of the Sayings upon our tongue through which we consume all realms of Knowledge—the very Bread of HhaALhhim, that is accessible to us through which we enter into the secret places of the Most High—being the hidden things in the most cherished Mind of AL.

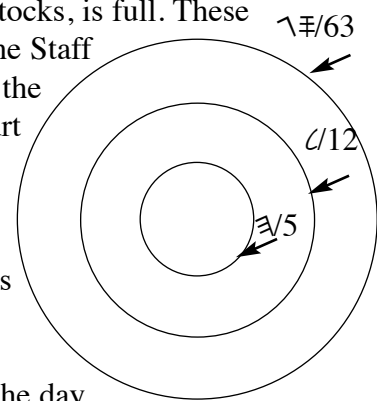

In accordance with the rotation of the Semek, we come to the four quarters of the month, which are the four *shavbethuth/sabbaths* in each cycle of labor. Every six days the Semek Ring moves 15° whereby we come to rest upon our chairs of Understanding (buttocks) on the shavbeth. According to these rings, so we sit and receive the instruction and guidance of Wisdom. When in the midst of the month, as on the 15th day, we are to be bowed unto one another, face to face. In the 30th day of the month, we are stand back to back to one another whereby we behold one another inwardly or from the north. In these patterns of rotation and shifts in our angles for orientation, so are AR and AL each evening and daily, whereby the entire fabric of consciousness moves like a ribbon in the Wind or like a flag lowering itself or unfurling its colors.

### The Rod of maShayh and Aharuwan

***The staffs of maShayh and Aharúwan, comprised of three rings of HhaALhhim, incorporates all Rings of ALhhim.*** The complete set of the Rings of the ALhhim are discerned via the thought process of the inversion of Numbers, whereby we see the interior and the values that are present within a number or combinations of numbers. Inversions lead us to the magnitude, operations and points that are directly proportional to the Numbers first apparent.

Value of 63 is an inversion of the Shayin-Semek Ring. The value of 6 is derived from the Semek/15, and the value of 3 from the Shayin/21. The inversion of the Shayin-Semek is 63, whereas it would be read as 36. The ring of 63 contains all of the Rings of HhaALhhim that contain the value of 36: the Shayin-Semek, the Rayish-Oyin, the Quphah-Páúwah, and the Tsædda-Tsædda.

The Ring in the middle, with the Number 12 is discerned by dressing the numbers to read 49, meaning to come, to appear. Whatever is appearing comes by the Lammæd, which gives structure and movement of the Breath. Though the Mæyim/waters are in the Tsur, they do not appear until the Tsur/Rock is opened. The teachings of the kuwahnim/priests of Aharúwan/Aaron are continually being sought after, for within them are all revelations of ALOZAR and the dwelling state of the Shayh/Lamb. Through the Number 12, the complete body of the Lamb appears. With the Rod of Aharúwan, the waters flow from the Tsur/Rock; the Rivers of Knowledge open, and the paths unto the Lands of Inheritance open to proceed therein. Within the Lammæd/12 is the Yeúwd/10 which is the Hand, or the means of extending the Rod. The Ring of HhaALhhim Lammæd-Yeúwd equates to 22. Those of the same Number are with the staff: The Neúwn-Chayit; the Mæyim-Tæyth, and the Kephúw-Kephúw. As noted above the value of 12 contains the ALphæh, which upon being fully extended reveals the Yeúwd. In that Understanding contains all of Wisdom, the value of 12 compasses all of HhaALhhim of Wisdom: the Zayin-ALphæh, the ÚWah-Bayit, the Hhúwa-Gammal and the Dallath-Dallath. The combination of the 12/3 + the 5 of the inner circle = 8; the value of all of the Rings of Wisdom. **Hence, as one looks at the 3 Rings, they behold there to be 7 Present, for each ring has two sides, making 6, and within their midst—in the centre—is the 7th.** The 7 rings in 3 are discussed in prior sections of this document.

*The three Rings of Numbers comprise the staff. Each Number conveys a channel of thought that comes from the staff. The means to conduct the thought from one end to another is called a rod. This is the origin of the staff.* As the Hand of Aharúwan gives all that is within AL to AR, the staff is formed. Through the staff the ALphæh passes from one to another; hence, through the staff all things appear, and all Seed of AL is transmitted. The values within the three Rings, as they are added, equate to the House of the Quphah-Paúwah which is the mouth of the priest.  $9+3+5=17$ /Paúwah, whereby the Teachings of the kuwahnim arise upon the lips as the Rock/8 opens, in that 17 is an inversion of 8. Much may be derived upon the combination of these Numbers. As one sees the sum of 17, the Yeúwd/10 is present with the Zayin/7. The base/foundation of the Paúwah and Yeúwd is the Gammal/3 from which the total summed is derived, being of the Gammal—three Rings.

In that each Ring is a conduit of information, the staff of rings is comprised of three openings or the necks/Gammalim. The inner neck is the opening to the House of Wisdom; the middle necks are the openings of Understanding unto Wisdom and unto Knowledge, and the crowning neck is the opening of Knowledge. Each neck provides for an extension for the Lammæd to attain unto its full measurement.



The neck of the femur supports the House of Wisdom. The Name of this part of the staff is called the Yakin, being the pillar within the Úwah-Bayit House of ALhhim. The Name Yakin appears in the House of Shamoúnn, which is the inner most ring of Understanding within the camps of Wisdom. Upon the pillar rising up amongst the House of Wisdom, is the head and body of Wisdom—depicted by the Dallath/Δ, setting upon the neck/Gammal of Wisdom. The head and body is evident by the triangle form of the pelvic area/loins that rest

Upon the right leg of Wisdom, the House of Wisdom sets, denoted by the Dallath/Δ.

upon the femur pillar of the leg. The loins are girded with truth—by the 1:1 ratio of words through which we affirm all things by Wisdom [Ephesians 6:14], whereby we stand firm and assuredly according to the Principles of ARAL. Until we come to the understanding of the 1:1 ratios, we see a facet of truth. In not seeing all of the truth, we misinterpret and mislead ourselves according to our inner distortion based on the spirit of partiality.

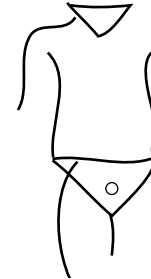

Upon the neck of Wisdom, the Head of Understanding rises, and upon the neck of Understanding sets the Head of Knowledge.

Within the House of Wisdom rises the Body of Understanding. The Body of Understanding forms upon the Dallath as the Kephúw rises into the camps of Understanding. The neck is the cylinder shaft of Understanding, within the Lammæd Ring, which is the neck of the pineal gland. **Together with Wisdom, which is the inherent Cardinals and ratios within Understanding, all things are made from the centre.** As the Fire within the bones rise, so the words are spoken, being uttered by the two tongues—the tongue of Understanding/Aharúwan and the tongue of Knowledge/Aparryim. Both tongues, being 7/I, speak the words in the gate of the Neúwn/14/7, which are the words of Life/5/א, 5 being a reductive of 14. In that the words are coming from the Fire/W in the midst of the bone of the Hhúwa ring, they are the words of the Shayh/אW. This Fire will not be quenched until every Word of the Shayh is proclaimed that pertains to the state of immortality [Yirmeyahu/Jer 20:9-13]. The words that the Prophets spoke, and by which they were made to feel ashamed, are now being seen and understood with the mind rising upon the Rod of Aharúwan.

The Fire burns in the midst of the Hhúwa Ring, which is in the midst of the bones. In this manner the Fire of the Shayh/Lamb radiates and fills the entire Body from within the midst, whereby there is no longer a need of any exterior light to shine upon us. As the outer form of mortality falls, the construct of the Temple of YæHúwaH rises upon a sure foundation of perfect Unity. The Light that we have carried during this age shall fill the Haikal in which all camps reside. War shall be no more; the harlot and her armies are overcome by the Lamb/אW.

Rings of Wisdom and Understanding, being 5 and 12 respectively, equate to 17 or 8, the value of the Rock/44/8. Within the Rock the Fire blazes as two stones are rubbed against one another. The Fire opens within the base of Wisdom to release the 1:1 Words. The Fire appears in the crown of Knowledge as the glory of the Words bring forth their blooms/fruit/seed of regeneration. As the two ends burn at the ends of the staff, the entire body of Understanding is consumed unto a new form. From the unified activity at the ends, the inward construct is transformed. In this way new skins of serpent are made, and the former are shed. The united activity from the ends, as ARAL, formulates the body of consciousness/Bayinah out of which comes the fruit or the evidence of the united sides. The fruit appears on the edges, in the circle of אפ/63/9, for the fruit is formed and structured within the Gammal/necks. The Tæyth, being the clay, is likewise on the outer edges, like a clay pit that holds the fire in the centre. The Fire that burns from the crown of Yaoquv/אפ and from the loins of Yúwsphah/אפא comes unto the centre, whereby all that is not of the Fire

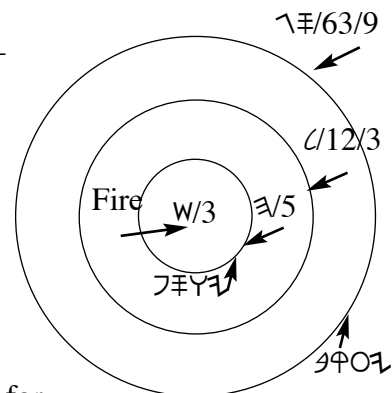

is consumed. The fires coming from the two edges of the staff is the vision of the Prophet Ovadyahu, whereby the former age/body is no more. All that survives the Fire is of the Kingdom of YæHúwaH [Ovadyahu/Obadiah 1:18-21].

Upon the House of Wisdom—united ratios, rises the walls of Understanding. In the midst of the House of Wisdom is the consciousness of Understanding from which comes all things of the Lammæd-Yeúwd inner ring. **The consciousness spirals around the Inner Rod and abides upon the ends of the rod as a baton with a ball of light on each end. Via the Lammæd, all things are measured** [YechezqAL/EzekiAL 40:3-5]. **Through the consciousness in the midst of AR and AL, all amongst the two pass freely.** The rod of Understanding and its neck rises from the foundation of Wisdom. Upon the House of Understanding sits the gate to Knowledge. The gate to the Knowledge of Yaoquv/Jacob is the neck that supports the head. *These two gates, or necks, are called in the Teuwrah/Túwrahh the necks of Beniyman/יָמָאֵל וְיָאֵל אֶלְעָזָר, for through them the ALphæhim pass* [Sepher Maoshah Berayshith/Genesis 45:14]. From all formulated within these necks, the offspring of the Neúwn are born.



The stone that sets upon the body of Understanding, being the head of the Lammæd, shall fall and break apart the legs of iron and clay, for the legs of mortality can no longer support the weight of its glory.

As the head of Knowledge is lowered unto the foundation of Wisdom, all three rings of the Lammæd become one circle. The right arm/א comes to the side of the right leg/ל, whereby the foundation of the House of YæHúwaH is laid with 22/X—the Totality of Conscious Unions. All sides are united as One, The necks are opened together, whereby the flow of information between the sides transpires. As the right arm takes the staff in its hand, the two pyramids at the necks join together, as a Magen David, from which comes the cube of 12 sides. This union of the two pyramids is also called the Tabernacle of David/דָּוִד. Within the midst of the sides is the staff of Understanding/the Ring of 12 that flows from its sides. From the sides of the Lammæd/12 is the Tree of Lives that bears twelve fruit in their season.

The union of the Ring of Knowledge, being 63/9, and the union of the Ring of Wisdom, being 5, are 14/ו or the double Neúwn/וּוּ. As the two, the one from above, and the one from below, become aligned, the gate of the Neúwn is in their midst for the passing from one world/state/age unto another. In this arrangement is the 1:1 ratio or the Tree/11/י of Life/5/א, being the sum value of 16/ו that is achieved by the Union of the gates/necks to be One Body of Light eternal. From their midst all fruit of Life that has no end is born. In the midst of the Rings of the Lammæd is born the body of immortality.

**The consciousness of the two united pyramids forms a Rock at the top of the mountain of Knowledge.** This is the rock that DaniAL sees that will fall upon the statue of Babylon and break it asunder, whereby it cannot be rebuilt. The stone upon the neck of Understanding shall tumble to the feet and break apart the legs of the iron and clay that support the age of mortality. The stone is the Mind of Aharúwan that is filled with the consciousness of the foundational words of Fire coming from the Shayh that is slain to provide the foundation of the Worlds of Light. The consciousness of the Shayh yet burns within these bones, whereby it rises as the ring of Fire as the Shayin-Semek ring. The Rock shall fall upon us like the glory of Yahúwah, descending from the top of the mountain until it crushes all that is beneath it, whereby the Kingdom of Yahúwah alone shall remain and be the state in which the 12 of the staff resides.

As noted above the staff is of three parts. As the staff is taken at the neck, it is cast down to devour the serpents of Metsryim. As the serpent consumes the Knowledge within the states in which it moves, it is taken up by the tail, whereby it stands upright, for none can stand unless Wisdom is their foundation. From this understanding of three staffs into one, there are three stakes upon which the Illuminator and those at the sides of the Body are hung [Mattithyahu 27:38]. The sides of the flesh steal from the inner wealth and use it for vanity. The one on the left is darkened to the Understanding in the midst, whereby the fruit of Knowledge that comes from its side does not return its Seed unto the Mind that formed it. Such is the folly of the world that mocks *the Understanding that is ever present within and which holds all things together as One*. The one on the right confesses to all that is within the House of Understanding, for what is of Wisdom, being of the south, recognizes the Faces of Understanding and will give all of its strength to see it appear again with Glory.

The three staffs are ONE in the hand of Aharúwan. Through the three staffs we are guided into the coming age and into the Lands which await the breezes of our united Breaths.

### The Staff in the Midst of the Rings of HhaALhhim

Consider the three rows of Letters of HhaALhhim—the row of Wisdom, the row of Understanding, and the row of Knowledge. These three rows are actually a Ring or one Eye of AL. Within the All Seeing Eye there are 7 rings, just like the EYE following the Order of the Eye of AL. When the Eye is single, one sees all things from end to end; but when your rings are divided and unjointed, you see with partial vision and thus are lead into all levels of misunderstanding and corruption. Each row has 4 rings within it, two rings around and two rings within. As these rings overlap or register one within another, there are 7 rings, which appear as three rings, each being of two sides with the core ring in their midst.

Each of the rings are EYES. In this record/*Leúwach of Lights*, all passes from one EYE unto the other EYE. In this manner the Seeds of Bayinah and Chækúwmah pass from one to another through the Eyes. As noted in the scroll of Chazon/Revelations, the Bodies of Light of the living creatures are full of EYES. As noted above, the two sides of each ring are called **the ring around and the ring within**. These rings are also called the Eyes of the front/belly and the behind/back in [Chazon 4:8; 4:6]. The 7 Rings are called the 7 Eyes, for they are of the Eye of AL, being the offspring of Aharúwan, from which all tribes are born [Chazon 5:6]. As you overlay the Rings upon each other, there are 7 Eyes which are the 7 Reuwachot/Spirits of the ALhhim. *They are called the 7 Spirits for they are the complete/seven, living Intelligence of AL*. The 7 Rings are comprised of the 12 Houses in their order of pairs, a pair for each of the Rings of Wisdom, Understanding and Knowledge, whereby there are two Rings for each House, being 1:1 in all things as is ARAL.

As the Rings are overlapped, they appear as 4 Rings in this order: Neúwn-Chayit, Zayin-ALphæh and Shayin-Semek are one of the Rings around all other rings. These are the Rings around each of the Houses whereby they appear as one ring as they are overlapped. The

Houses of Mæyim-Tæyth, Úwah-Bayit, and Rayish-Oyin are another combined Ring. The Houses of Lammæd-Yeúwd, Hhúwa-Gammal, and Quphah-Paúwah are another set of rings. The Houses of Kephúw-Kephúw, Dallath-Dallath and Tsædda-Tsædda are the three levels of the inner rings. In arranging the rings in this order, one makes the Menurahh from the inner out, for all Light is from within, *whereby we start to light the menurahh from the central Branch.*

In the Eye of AL are the 7 Rings, which are 6 Pairs of Eyes with a paired-joined rod in the midst. The rod is called ARAL. This rod is put into the hand of maShayh and Aharúwan and is passed through every member via which we travel from one state unto another. According to the Head of the Rod, so is the direction of the movement. This is the same rod that is passed around the Pesach table through which we arise through Metsryim.

**Each ring is a ring around and a ring within.** The inner core is ARAL and the Hand of the Priest that serves in their midst. *When one looks at the Menurahh from the Top, one can see the seven Rings or the seven Eyes [Chazon/Revelation 1:4;4:5-6;5:6].* The seven Eyes are the 7 Spirits—the flaming thoughts that go out from the mind to see how long they are and what they are able to detect into the spaces of their Names. In this manner the tongue of the serpent searches through out the dens and the nest for the eggs that have been laid. Each Eye is an Intelligence of AL, according to one’s insights so are the levels of your Intelligence. Every Name is born in of one of the Rings to which we belong eternally, whereby we are the offspring of ALhhim. Within each Ring are Houses and Families of Associated Thoughts.

The First Ring is the *Neúwn-Chayit, the ring around*, and the *Mæyim-Tæyth, the ring within*. In this Ring of Intelligence is all blessing and the means to transform from one level unto another. Through the Neúwn Gate/neck passes all thoughts which extend the Lammæd. As the thoughts of Yúwsphah enter into the Neúwn, the Fruit of Knowledge is formed as the heads that rise upon the shaft of the Lammæd. In the Fruit we behold all colors and the full spectrum of the Lights. The source of the colors are in the Ring of Yúwsphah to whom belongs the garment of many colors. The full spectrum of Lights come from the first Ring and are evident in the fruit that rises from the womb of the Neúwn.

We enter into each Ring by Breath, and by the washings of the hands and feet we are identified to be initiated into the order of the ring, and hence we have access, by our Reúwach, to enter into one of the 7 Eyes of the Breath/Spirit. Flesh and Blood cannot enter into this EYE. The flesh of mortality robs from the Rings of Light by extracting the values within to build itself a body apart from the Rings, whereby there is a body of outer darkness. The mortal realm is a world apart from the Body of Understanding. The mind of the mortal body steals the lambs of AL and feeds upon them for their indulgences. The minds of Babylon/confusion do not know the paths of the mishkan. Hence, they use the lambs of YishARAL for their own ideas, desires and deeds. *The mind that does not love the lambs within their fold are like the heirling that runs when the wolves come to eat their master’s flock. Instead of coming into the House through the gates of the Lauúwim and via the washings of the hands and legs they pass through the wide gate and rise with the fruit of mortality within their thoughts.* They do not know the gate keepers who abide amongst the flocks as Shepherds; rather they enter the sheep fold from the sides, where the fruit or the offspring are forming. From the sides they withdraw the offering of lambs



for their alhhim/gods. In this manner, the offspring are sacrificed to demons and idols, for they are used in ways contrary to the Order of AL and the Order of the Pairs of Letters.

The Intelligence of the 7 Eyes is broken by BEL, whereby the body of mortality is divided unto itself creating a gate that is wide unto destruction. The wide gate is the path that is created between the lower pillars from the result of a divided body. *The gates to the Rings are concealed and entered through the necks of the Neúwn* which are hidden from the proud and the arrogant who desire the things of this world.

Breaking the rings is violating the Unity of the Rings. This is the same as breaking the covenant of the ALhhim, for all Rings are in agreement to be One Dwelling of AL, and *all of the words of the Covenant come from the United Rings*. Herein is the difference between the tongues of mortals and the language of the Oovri [Ancient Hebrew]. All of the words of the Oovri are of perfect Unity, being 1:1 ratios of thought, but the words of Babylon are formed by division and uphold the ways of division, whereby they speak of those things which are apart instead of that which is ONE cloth/fabric of Light. *Hence, we cannot speak unto any thing that divides the consciousness as death, gender, war, bond or free, for such states are not in the Rings of HhaALhhim*. Via breaking the agreement of the 1:1 Rings, the city of Babylon is built upon the sands that rise and fall with the tides, for The Rock is not beneath them. The city of Bel is the formulation of the body of flesh that is created to be a harlot's body that seeks to woe all of YISHARAL into her EYE through wanton eyes, lined with dark lines of appeal, and accepts mixed seeds into its dwelling which is not for the profit of thought. which is a war of the flesh to engulf the minds of the offspring of Breath.

The Rings of the Neúwn-Chayit and Mæyim-Tæyth is the means to formulate **the Body of Understanding**, which is a House of 1:1 built upon the Rock. In this Ring, being between the inner residence and the sun, abides the moon to orbit in our midst night and day. The moon regulates the waters, as they rise and fall, for the Mæyim is the ring within the ring around. The Body of Light seeks not to enslave or hold anyone captive, but to illuminate all Names as to their position in the House of YæHúwaH. The fabric of Light is composed by the Names of ARAL intertwining which is true queen feminine body of Light; the body of flesh therefore is estranged and perishes in that is not a weaving of Names, but abides separate unto itself; the Taúwah is doubled in the Name, as the first strand/X is of Wisdom, and the second/X is of Understanding, and from this union Fruit of Knowledge comes forth in its season.

**The inner Ring of the Neúwn** is *the Lammæd-Yeúwd ring around and the Kephúw-Kephúw ring within*. The Gammal is the supportive neck of Wisdom upon which the Body of Understanding spins within the staff. Around the Lammæd Yeúwd ring all rings gravitate and spin, and in the inner core of the Lammæd is the Tree of Lives. **One must pass through the gates of the Lammæd, the portals of the Lammæd, prior to entering into the Kephúw-Kephúw in which is the Tree of Lives**. As the Life is in the midst of all things, so the is Tree of Lives in the midst of the staff of the Lammæd. Thus all must learn the commandments at the hand of the kuwahnim/priest of Aharúwan to be able to come unto the Tree of Lives. Whereby it is written, ***“Blessed are they that do the commandments, for they shall have right to the Tree of Lives.”*** The Lammæd-Yeúwd and the Kephúw-Kephúw are paired Names of HhaALhhim in the Rings of Understanding.

**The Eyes of Wisdom** are the Rings of the Zayin-ALphæh, being the ring around and the Úwah-Bayit, the ring within, whereby the ears are the within the fields of the eyes, for the eyes extend further than the ears that are within seeing. One sees and then hears or comprehends. If the tongue is not speaking the words of Light, the eyes are dull and sleepy. When the words of AL are spoken, the eyes brighten and the ears then perk up. This is what it means that the eyes are begotten by the Zayin-Alphæh for they are the firstborn of the Serpent as the Hand of AL, being Aharúwan is extended, but the firstborn of Aharúwan before the Hand is extended is Yahúdah, for without the offspring of the Quphah-Paúwah, there is not the wherewithal for the priest to speak. The second Eye of Wisdom is the Hhúwa-Gammal, being the eye around, and the inner part of the Eye is the Dallath-Dallath. Herein is the Mishkan that rises from the pairs of thoughts being emitted through the Enlightened Gammal—the inverted Staff of the Lammæd in which is the Dallath. The path into the mishkan is through the Gammal as the path to the Tree of Lives is within the Lammæd. The Gammal is on the right, being the inversion/mirroring of the Lammæd within the Ring of Wisdom. One enters into all of the Mishkan via the Gammal to discover every paired attributed of Light—the Hhúwa.

**The Eyes of Knowledge** are the Shayin-Semek, ring around and the Rayish-Oyin, the ring within. The Shayin-Semek is the fiery pillar that distinguishes the thoughts to be of Wisdom within camps of YishARAL. Look for the pillar to appear as Words of the Fire are being spoken. As the Words of Fire are uttered from the kuwahnim a pillar of Fire flames from the head of the Lammæd. Inside the Ring of Fire—ShayinSemek are layers of thoughts and consciousness, in which Shepherds of YishARAL abide. Those who are capable to lead with the Lammæd abide in this Ring, amongst which are the shepherds who love the sheep as their own flock and will defend the Order of AL when others come to rob the sheep. This Eye is the Keeper of the Flocks birthed from the arising thoughts of Wisdom, whereby division is not consented. The corresponding right eye of Knowledge is the Quphah-Paúwah, the outer ring, with the Tsædda-Tsædda, ring within. The words of Knowledge flow from this Eye as tears shed with the flow of oil from the Oyin. In this manner the Eyes pass their Seed Words unto one another. Hence, in the Quphah-Paúwah flow the oil of the Rayish-Oyin. Within the statements of righteousness are the words of Liberty held within the Tsædda-Tsædda. These are the upper branches of the Tree of Lives and the means for your Name to redeem ITself by the kinsman redeemer that abides therein.

In the center of these six Eyes is the EYE of ARAL that keeps all in motion and with the ever abundant supply of Light. With ARAL the Light of the Shayin-Hhúwa flows from the base of the inner ring of Wisdom to the outer ring in the crown of Knowledge.

One may behold the seven rings within the Faces of HhaALhhim. For in that the Breath of HhaALhhim, the Rings are evident in the remains of the image that is being carried within the faces of our mortality and shall arise in the complete image of our perfect Unity.

As a tree extends, it branches and bears fruit. The House of YishARAL are the fruit born within the branches of ARAL. The Body of YishARAL is *the body of the LAMMÆD* with the YEÚWD—*the hands* of FIRE which arrange in pairs the 12 Branches of Fire into *the Burning*

*Bush.* The Ring of the OYIN/O is the consciousness amidst AR and AL. In the midst of the OYIN/O is the ZAYIN/I which is the Word of ARAL and the means to open the Seed of AL as it is transmitts unto AR. The ZAYIN is the instrument of the tongue upon which the grain is laid and then proclaimed by the Breath of AL. As the SeedWord of ARAL is spoken, the branches of Thought appear as rings of a tree. In the spreading out of their Unity, all 12 branches, being of 3— Wisdom, Understanding, and Knowledge fill the spaces of ARAL.

The Lammæd/Yeúwd releases the messages of AL whereby the branches break forth from the sides. In that the Lammæd-Yeúwd Ring is in the midst of all other rings, all of the Houses of YishARAL are born from the center of Laúwi, each in their order of unfoldment unto the full expression of ARAL.

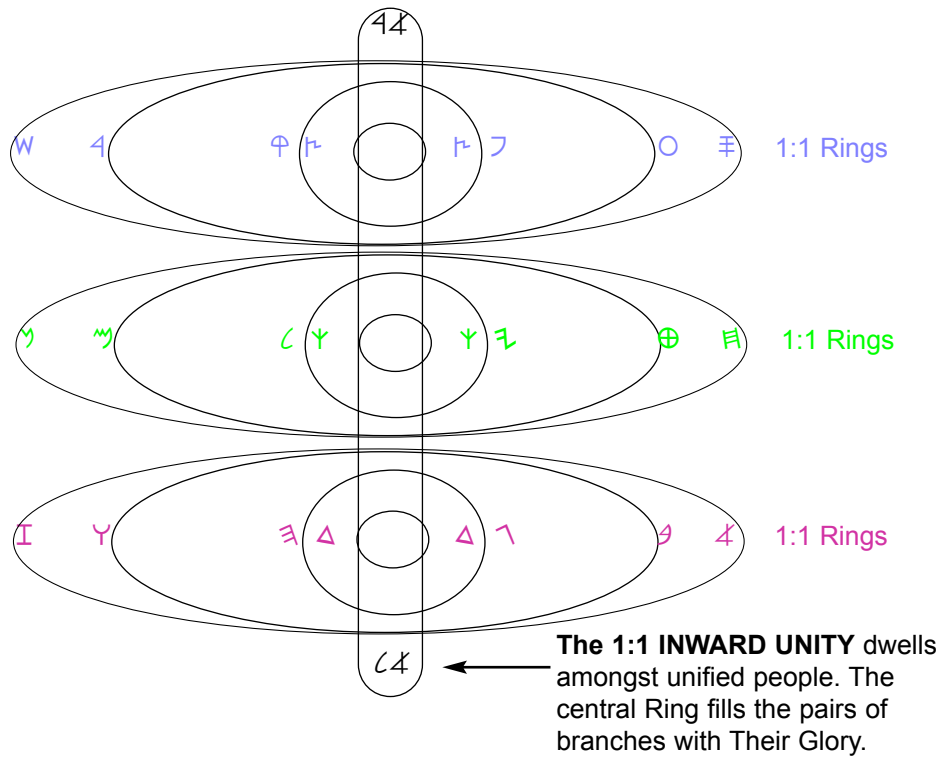

### The Single Eye

The Rings, perfectly aligned in agreement, form the Single Eye, as in the Head of Aparryim, wherein all becomes to be seen and understood. The united 6 rings of your Name are aligned around ARAL, the inner core ring as the 7th, and with their pairs, they are 7:7 as ARiAL is 7:7. The Single Eye is called by the Name of Shucham of Dan—RAúwaben, for it brings all the eyes of RAúwaben into One.

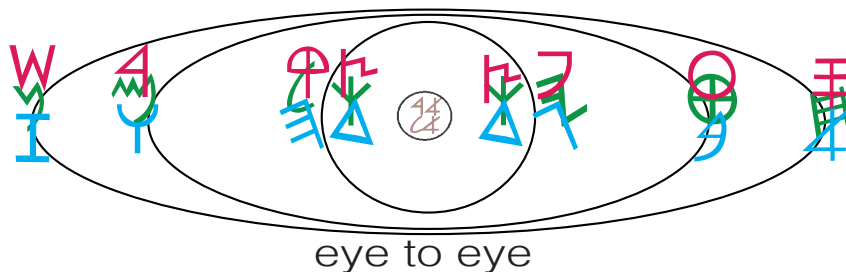

## The Rings of the Mishkan Curtains/Veils

HhaALhhim organize their thoughts together to form a perfect dwelling that conveys their Unity and attest to their devotion unto one another. This body of organization is called the mishkan/tent of meeting/detailed in the complexity of the bodycells. The organization of their thoughts leads to a dwelling that is filled with all attributes of Unity and Light, in which they collectively reside, move, and have being. The remnant of HhaALhhim are Rings apparent within the body of mortality, in which a Name may sojourn as a stranger. What remains alive within the Name is an ability of revitalization of thought—belonging to a relative or one of kin relationship, chiefly to the Ring of HhaALhhim to which the Name belongs. The rings in the body of mortality appear as a swelling of flesh, which is a reminder of the Rings of HhaALhhim from which all houses of thought are derived. Only the remnant of the Rings—what belongs to HhaALhhim—shall return, for the flesh of mortals is not created by HhaALhhim, but rather as a fleeting appearance testifying what is within your Seed; and hence, it does not return unto the Rings of Light into the Body of the Shayh/Lamb. As to your ALhhim/Elohim, can you create the Lights that are already within you? In the RASH/Head (as in BeRASHshith/Bereshith/Genesis) there are compositions that rise and manifest—appear, as likened to the head of a tree from which an entire body appears in days, until it is seen fully to be complete/seven. The Body of HhaALhhim is a re-newing formulary, being composed of the fruit of Knowledge in which is the Full Counsel of Wisdom and Understanding. The Body of the Lamb has no corruption or leavening within it, but is free, being of the 0:0 Ratio of Mind—the compound Numbers of Understanding, whereby the form of the Body is of perfect pairs woven into One.

All begotten of HhaALhhim carry the pattern of the dwellings of ALhhim within their Names. Each of Names of HhaALhhim are born within one of the Rings of Light. According to their birthright, all Names know of their dwelling amongst all of the Rings of ARAL. The basic and foremost instruction of HhaALhhim is to preserve the Unity of the Rings, whereby they are not to be violated. We serve each other as we serve in YæhúWah—the Collective Name of your HhaALhhim/יְהוָה אֱלֹהֵינוּ. As each of us comprise a part of the collective, we abide within the branches of AL to which we are read/called and Named. ***In our positions we serve the collective with all of our understanding/heart, with all of our expressions/soul, and with all of our steam/might***, bringing forth the emanations of our Thoughts formulated in Breath. *The first Order/commandment is to serve the collective, and upon this deed, all of the Teúwrah/Túwrah hangs/depends.* That is to say, that every deed to fulfill the commandments are dependent upon the devotion to one another with all of our heart, soul, and might. The aspect of *all of our might* is to serve *each other as we are given distillation of thoughts to bless and uphold each other within the Rings* to which we belong worlds without end. In so doing we commit our strength to each other through which the cords amongst us cannot be broken asunder. The Order of the oylah is the fulfillment of this Primary Order/commandment, for until one loves with all of their heart, soul, and might they have yet to make the offering unto YæHúwaH. Though the first commandment is called the greatest, it does not imply that this saying is above any other Word. The term, greatest, indicates that the saying is the substance to nurture and provide a framework for all of the Teúwrah to be performed. *Through the oylah, the greatest and all those affirming words/commandments are fulfilled. Literally, we are to nurture and build one another up with total understanding, total expressions and complete thoughts, and having done all to stand and*

*remain steadfast in all that is given.* The commandments being “second” to the “first,” are *the affirmations of the first amongst the Orders of the Rings*, whereby the second, or the affirming statements, are as great as the first, for they also admonish one another unto the fulfillment of every Word of AL.

In the State of Breath Thinking occurs to determine our course of direction, whereby we move within our dwellings. The dead, as the corpse does not think but lies dormant as a garment that has faded. In accordance to our abiding within the Rings, the Collective is served and maintained to be the foremost Order in all thoughts and proceedings. Through the will of Breath we give of our hearts unto the altar, then we arrange all of our members around the altar, whereby we give all of our soul. Thirdly we move by the distillations of thoughts that are emerging from the members, whereby we serve each other with our strength/might.

The remains of abiding within the Rings of HhaALhhim are carried with us into every age of thought and within every state of dwelling, even though the dwelling is in hades/gehenna/hell. The patterns in the mortal realm are like to those above, whereby the remnants of the patterns of the Rings in you are sufficient to awaken you unto the Great House of Names to which you forever belong.

The dominating rings in the bodies of this world are the witness of our origin in the Rings of HhaALhhim. “Remember the days of former offerings/states of ascension; consider the years of generations connected to generations. Ask of your Progenitor, and one will declare unto you; your Alders, and they will speak to you [Meshneh Teúwrah 32:7].” Where have we come from? Look to the generations to which we are connected, and we behold the ever spiraling cord of thought in which are the circles that are so evident within our anatomy.

Rings of the Mishkan are evident from the head to the feet. Around the head is the glowing Ring of the Shayin-Semek, called also the helmet of salvation, being an aura of Light. Inside the ring is the Shayin-Semek, the head of the body, being the Ring of the Rayish-Oyin, known also the Ring of Consciousness formed by the rising thoughts of the oylah. Within this outer Ring is the crown upon the brow unto the crown upon the lips—the Qúphah-Paúwah Ring. Within the Ring of the Qúphah-Paúwah is the Tsædda-Tsædda, the network and branching within the mind, where the thoughts have no harness but are as the wild horses and the goats that roam the peaks of the mountains.

In the midst of the Head is the Foundation of Wisdom, the Ring of the Zayin-ALphæh, being the eyes, and the ring within, the Úwah-Bayit, the ring of the ears which is heard in the midst of the eyes. The Zayin-ALphæh is the most narrow band, being able to focus as a detector, whereby we can see and hear from afar.

Around the body is the Ring of the Neúwn-Chayit, formed by the rounded shoulders unto the crest of the hip bones. The Neúwn-Chayit is the broadest bond, whereby one may profit through the full measures of grace ever abounding from the midst. Within the Ring of the Neúwn-Chayit is the Mæyim-Tæyth, coming from the inner walls of the Neúwn and encompassing the heart. Within these Rings are the white pearl and the black pearl. The white pearl is

the opening of consciousness to the Foundation of Wisdom; the black pearl is known as the pearl of great price, for its value is the price of total consciousness, and through which one may pass from one realm unto another.

The outer shape of the hips conforms to the Hhúwa-Gammal outer Ring, from which the Dallath-Dallath appears in its midst. The fabric of the loin cloth is called truth, for it affirms by the 1:1 properties of Wisdom all statements of Understanding. In the midst of the Hhúwa-Gammal Ring the white pearl of expanding consciousness is seated.

The Lammæd-Yeúwd Ring is the staff in the midst of the Rings, in which are AL and AR. The inner most Ring is the Tree of Lives that is accessed via the 12 gates of the Lammæd. One proceeds through all of the gates of 12, whereby they are affirmed to enter into the Lammæd-Yeúwd Ring of Life.

As the Rings face one another they form spaces. Literally the facing of one another is a squaring-off, for by the associations of the Rings, all items of the mishkan are formed. The forming of the dwelling state, or the mishkan, is only made by associations. No one Name can build the House just as the House of YæHúwaH is built by paired ALhim. Through associations of thoughts and paired Names the spaces of the House of YæHúwaH are determined. According to the Names that are joined, so are the spaces and the

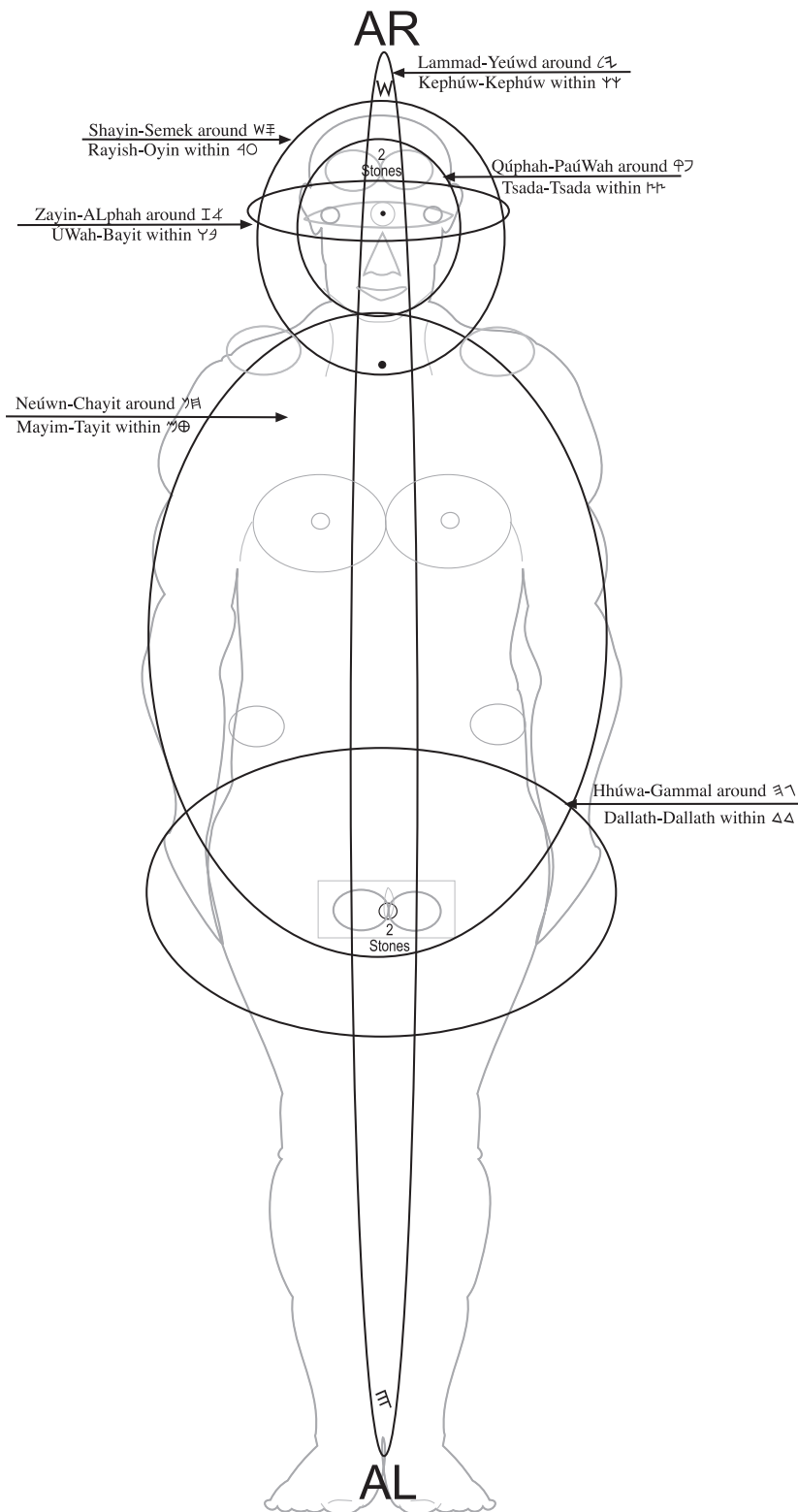

functions of the spaces. The menurahh is formed by all rings united, being 7:7 with the Name of ARAL. Everything in the House of YæHúwaH is made through a complete giving, whereby there is a perfect alignment of all associated rings as the Menurahh is formed of two complete sides. The Menurahh is the fullest extent of the Rings, whereby the full measures of the Light emanate within the associated pairs without limit. The Light of the Menurahh is the Light of the Lamb/אW, that radiates from the base of the Lammæd—the central Rod in the midst, unto the crown upon the Head of the Staffs, being Aharúwan, in which is Mashiyach. The Head of all Staffs is the Enlightenment/Aharúwan that rises to the top of the staff, and bears upon its branches the ripened fruit of the ALmonds/אךΔΦW.

According to the extent of the thought and its placement of service within the Rings, so is the configuration of thought that appears. The full revelation of our Names comes as we are aligned together, as in the Mind of ALOZAR, whereby the spaces and the flesh/faces of our associations bear the image and the likeness of ARAL.

The hands move according to the Hhúwa-Gammal Ring of Wisdom where they lie upon the sides of the ring. The hands are active to implement the Principles of Light arising from the cardinal Numbers, whereby all works are done in the 1:1 ratio of Wisdom. The deeds of our hands reveal the concepts that we have in our eyes, whether our eye is One or whether we see apart from the Rings of HhaALhhim. The hands extend through the Dallath-Dallath Ring into all works of the Mishkan. As the hand are cleansed/initiated/readied in the Hhúwa-Gammal ring of ALhhim, they serve within the Dallath-Dallath to perform every deed pertaining to the Union of Names. The value of a hand is 20/ץ, for all deeds lead to the Tree of Lives. Two hands have the same value as the Name of Aharúwan—40, whereby they perform according to Enlightenment through which all things are made. The hands of Aharúwan are hands of the potter’s wheel.

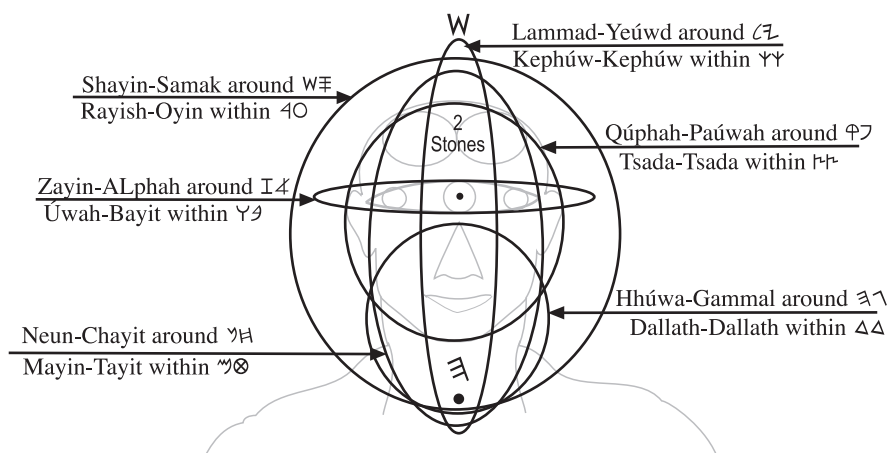

The Rings of the Pattern in the Mount

The 7 Rings of Light are first in the Head and then in the Body of Understanding, which is a drawing out of all that is in the Knowledge of AL. As we enter into the Knowledge of AL we are prepared with the garments and their activation via the blood of the daily kevesh to enter into the Rings of HhaALhhim.

All Rings are in the two Stones of AL. These are the Stones that are fused to be One, whereby there is One ROCK. As two breaths intertwine, each being of the distillations of the Mæyim/13, the pattern of the Rock is established, making 44 ( $13/4 + 13/4 = 44/HhaTsur$ ). The two stones are located in the Tsædda-Tsædda Ring, whereby the Teuwrah is called “The Law of Liberty.”

When the Shayh/אָו is offered, the worlds began to be made and all that is within them. The oylah is the heart beat of the Teuwrah, whereby every LAW is perfectly performed. For without the oylah no commandment is done as unto AL. Every part of the oylah is a commandment of love/service unto the unity of the Rock that cannot be divided.

### The Rings in the Bodies and Dwellings of Light

As Rings of Light unite together, they form the cube and the perfect Teraysarun Order of Names. As in every circle there are 4 points, so likewise in the Rings there are 4 corners. The 4 corners in the 7 circles of light are 28 points, the reductive value of 1. As the circles are expanded by the Neúwn, there are 14 circles with 56 points. The union of these 14 circles, 7 of AL and the 7 of AR, form the Name of ALOZAR, 56 an 11, are a 1:1 ratio a perfect dwelling.

All forms are of Light, for how do they appear if not by a frequency and wave of Light? If the appearance of a form is of Light, then to what level is the appearance? Is it direct illumination or reflective illumination. Does it bear a semblance of the Light or is the form the shape of the Light itself? All that is flesh is of the Light, for according to the spiritual level of thought, so a form of flesh appears. The age of the form is determined by the length of thought around which the flesh is spun. For the length of the thought is the length of the rod by which it is measured, and therefore it has an appearance. Is the flesh the embodiment of HhaALhhim or a form that has turned its faces from the Rings of HhaALhhim? **When one turns their back to the Rings, they display a shadow. They walk in shadows until they turn their faces back to ALOZAR.** If they bear not the direct faces of HhaALhhim, then the form is of the indirect illumination, yet it retains traits from that which it has come. For though a Name is Light, in that it is born of Light, yet should it turn away from the Faces of HhaALhhim, it comes to reside in a body that is apart from the Rings. The body which it makes apart from the Faces is a shadow, and in this shadow the Names walk until they return to the Flesh of HhaALhhim. The mortal body contains corruption in that it has turned from the Unity of Names, and therefore dwells apart from the Unity of the Rings. Though the mortal nature contains the patterns of the Light, it is not the Light nor of the Faces of the Light, yet it is a fruit of the Light of the Name to which it belongs. The seed within the mortal body is of clay and iron, but the Seed of the Name that is of Light, has all attributes of the Rings and is therefore capable of transferring from one state unto another. In that the Name is of the Light, the body in which it forms has a semblance of the Light. What is of the remnants of the Light speaks of the Origin of the Light. The messages from within these remnants prick at the sides of the Name to do an about face and return to the Light. If the mortal body is the pattern of the mount, then why seek for another? If it is deemed that the mortal body does not equate to the Names of immortality, then why continue within the design of the imperfect and support its continuance? Within the Rings, we behold the pattern of all comprised to build the Mishkan.



Those without the Rings walk at various levels of understanding. Those turning to the Rings are not the same as those which faces are turned away from the Rings. Those who turn their faces to ALOZAR receive the direct Light of the Rings to guide them home. The Light is given in sequence of steps and with measures of understanding so that one does not lose their footing in trekking up the mountain of AL. Those which have not turned their faces to the Rings of ALOZAR stumble about as the blind. Ask that you may receive; seek that you may find; and knock that a gate will be opened for your Name to find again the paths of the Qadam/Origin into the Domains of Light. Those which turn their faces to the Rings, do the same as those in the Rings while they are yet apart. Those whose faces are turned aside, take no heed to the Order that is within the Rings, whereby they continue to walk in the shadows of their mortality and the unions of mortality. At which table do we dine: the Table of the Faces or the table of wantonness? Of which Light do we walk by: the Menurahh of the 7 Rings, or by the sun and moon of the natural world? Which flesh is found to have no corruption and which flesh perishes? When one's state is of the 1:1 ratio of ALOZAR, being impartial and bound by the affection of AL, Name to Name, then the flesh is of the bone of AL and is thereby perfected, which does not perish [I Yahuchannan/I John 4:16-17]. For as AL is to AR, so are we to be one to another, for so are we also in this world, though we be not of this world.

There are black texts and opaque forms of darkness, but this is not what is meant by the outer darkness. There is darkness within Rings, for within them are all forms of thoughts, those opened being of Light, and those yet to be opened being of veiled darkness. When all is opened within the Rings, then the Light of the Shayh has come, and the Dwelling of Names will rejoice in the brilliance of the Light. The darkness also will rejoice, for their salvation has now come. But there is an outer darkness, that which is beyond/outside the Order of the Rings, in which are all forms of aggression and disorderly conduct, for the thoughts that are dwelling there are imperfect and partial unto themselves. As the Light of the Shayh comes to those who are dwellers of forms, and those yet seeking the perfect, then the darkness vanishes, whereby sin and transgressions cease [Yeshoyahu/Isaiah 60:1-3;19-21; Chazon/Revelation 21:16-27]. ***The union of the Rings of AL and AR are the perfect dwelling which is sustained by the perfect Union of Paired Names.*** The Rings of United Names are perfected as they are united to from the pattern of the Rock/HhaTsur [Mishneh Teuwrah/Deuteronomy 32:4]. According to the Order of the united Rings, we speak our words and perform our deeds to convey the Perfect, whereby we are Perfect as the paired Ones with YæHúwaH are Perfect [Mishneh Teuwrah/Deuteronomy 18:13]. This dwelling is the Mishkan Tabernacle that is seen in the mount, the Tabernacle that comes down into the expansion of the Rings through the gates of the Neúwn [Chazon 21:1-3].

**The Mishkan is called the Tent of Congregating or the Tent of Meeting because it is constructed with the congregation of HhaALhhim meeting together into ONE House called by the collective Name of YæHúwaH.** The Mishkan is the House of HhaALhhim/The Gods. According to the meeting of HhaALhhim together, the Mishkan is built. The pattern of the Mishkan is in the mountain of AL. Those having the Mind of the Rings are able to build the Mishkan; without this Mind the houses that are built are upon the sand which falter. Within the Mishkan, there are meetings of HhaALhhim. HhaALhhim are paired one to another through which their works are established. According to their pairs in their sides, so are their words and

their works. Wherever they congregate, they establish a form of Light through which their Words of Light are formed and from which the Words of HhaALhhim are transmitted by the mouth of angels. When their words are sent forth, they are carried by the wings of their messengers. The messengers and the prophets belong to the Ring from which they are sent. They send forth their words as they do not leave their house or dwelling of qudash/designated unions. They remain in the state of paired positions whereby the House is secure at all times. When one leaves the Union of Names, they are subject to attacks at all levels. All of the Rings of HhaALhhim comprise the Mishkan. The services of the Mishkan are the works of Light. Those who perform the works of the Mishkan testify that they belong to the Rings of Light, for *these are the works of Light that the Offspring of HhaALhhim perform*. Those who perform Works of the Rings are acceptable to AL; these may be immersed into the waters of the Kingdom, whereby they may enter into the gates of HhaALhhim [Maoshah Shlichim/Acts 10:34-35, 44-48].

The works of the Mishkan are according to the Rings. **The rooms/spaces within the unified tent of meeting are seven, being the complete works of Light.** These works are of the washings—activations; offerings, inhalations of incense; the ordering and the Lighting of the Lamps; the Table of the Faces which reveal the flesh of HhaALhhim; and the study of the Teuwrah, and the showing forth of mercy through which the Teuwrah is taught and sent forth to all peoples. The servants are sent forth in pairs as the two face-to-face cherubim upon the mercy seat.

There are three that serve the Mishkan: the House of Qahhath, for they are of BethLechem and the Offerings of the Fire; the House of Gershun, for they are of the Flesh of the Fire; and the House of Merari, for they are of the Bones of the Fire. These are those that are with Aharúwan in whose hand is the Rod of the Mishkan, whereby the Mishkan moves according to the works that are performed without ceasing. The House of Aharúwan and their garments shall be qudash/sanctified in your minds. Each Ring is depicted by their works of the Mishkan, whereby the House is One, being perfectly united. As one enters the tent of meeting, they pass through the Rings. The Rings of their Names resonate within the congregation who are meeting within the sacred halls of the Rings. According to your works, so are you known in the House of ARAL.

The **Hhakaiyúwer/laver** is built by the Rayish-Oyin and the Quphah-Paúwah. These rings congregate or meet within the Rings of the Hhúwa-Gammal. In Hhakaiyúwer the hands and feet of the offerer and the parts of the offerings are washed prior to being arranged upon the altar of Knowledge/Bronze.

The **Altar of the Oylah** is the meeting place of the Rings of Mæyim-Tæyth and Quphah-Paúwah. These meet in the Ring of the Dallath-Dallath. At the altar of oylah, the blood of the offerings produced through the Mæyim-Tæyth from all of the camps are brought to the Mind of the serving Priest of the Quphah-Paúwah.

The **Altar of Incense** is built by the Rings of Shayin-Semek and Zayin-ALphæh. These meet and congregate within the Quphah-Paúwah, as the House of Dan and RAúwaben gather into the courts of the kuwahnim/priests.

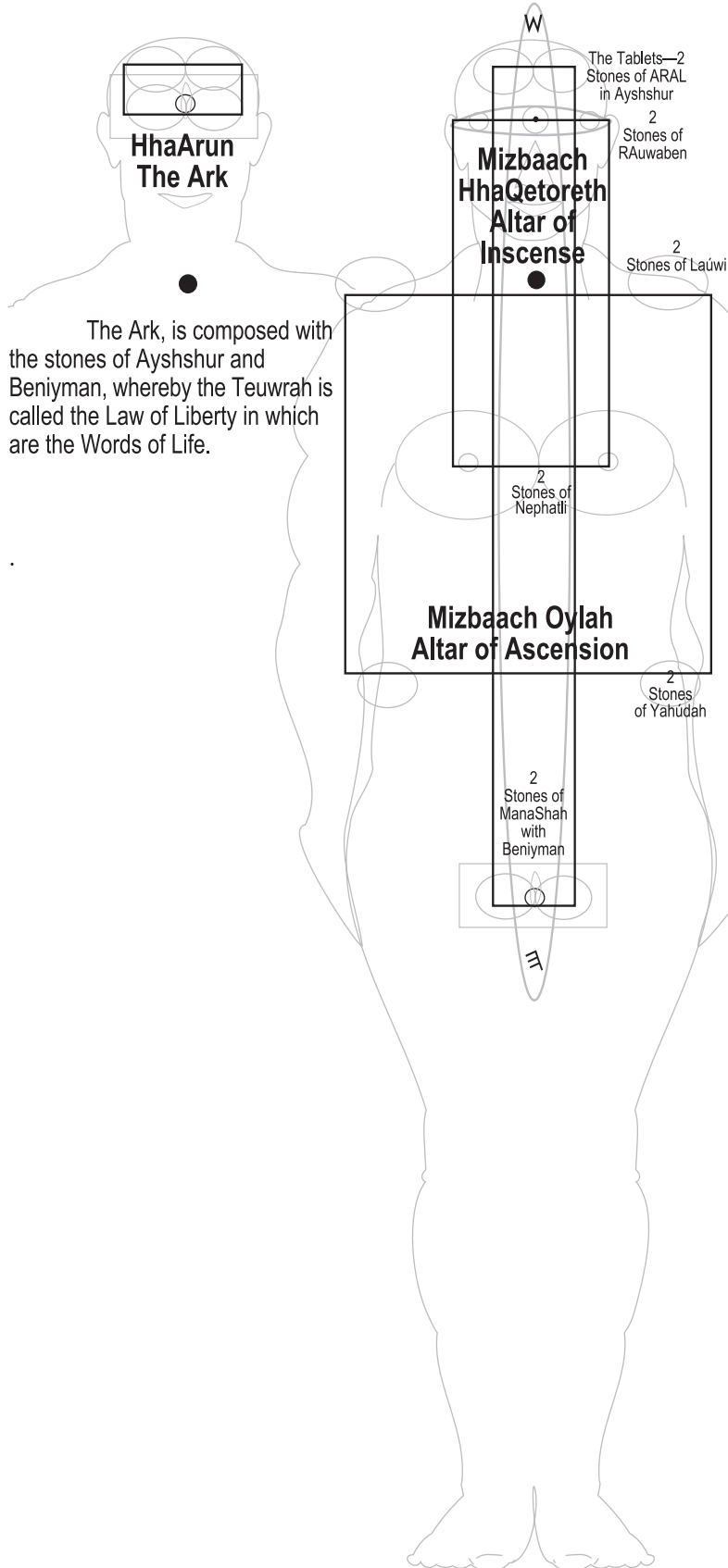

The Ark, is composed with the stones of Ayshshur and Beniyman, whereby the Teuwrah is called the Law of Liberty in which are the Words of Life.

**Shulchan HhaPayanim Table of the Faces**

As the Mind becomes aligned with the stones of ManaShah, an oven is created by the stones in which the grain of Beniyman is baked into the unleavened cakes for the Shulchan, whereby the grain does not become leavened by breath/spirit of this world.

Six loaves are made for the evening and six loaves for the morning, whereby we have Hhúwah, a half—the measure of Light for the evening, and Hhúwah, a half—the measure of Light for the morning. The Bread is comprised of all of the Letters in the Rings, for such is the composite nature of Light.

The Bread of the Evening:

The Bread of the Morning:

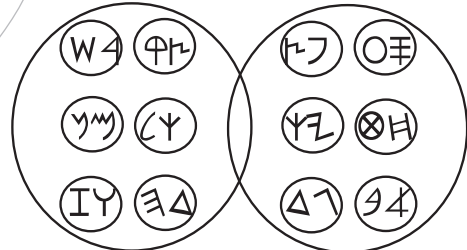

The Bread of the Evening pertains to the 6 Houses of YishshARAL, namely Dan, Ayshshur, Nephathi, Yahudah, Yishshakkar, and Zebulan.

The Bread of the Morning pertains to the 6 Houses of RAuwaben, Shamoun, Gad, Aparryim, Manashah, and Beniyman.

The Bread is prepared by Qahhath for the Enlightenment—the serving kuwahnim/priests who are ministering in the Temple. It is called the priest's food for it is the Word that is sown by the priests of AL and returns unto them from all of YishARAL.

The **Menurahh** is the intertwining of all Rings into one Body of Light. The six Rings of the united ALhhim all congregate within the central Rod of the Lammæd-Yeúwd Ring. These six rings congregate by their pairs around the Kephúw-Kephúw. This congregation is called **The Great Assembly** for it is gathering of Wisdom, Understanding, and Knowledge. The Menurahh is known also as The Counsel of the Seventy. From this great gathering of Light, the body of the Sanhedrin arose.

The **Ark/Arúwan** is composed of the Tsædda-Tsædda Ring and the Ring of Neúwn-Chayit which meet gather with the kuwahnim/priest of the Quphah-Paúwah. **The Stones of Beniyman—Neúwn-Chayit and the Stones of Ayshshur—Tsædda-Tsædda resonate to one another, whereby the Teuwrah is composed from end to end, being complete and lacking nothing.** The Quphah-Paúwah, in which are the cherubim meet face to face with the Úwah-Bayit Ring, whereby the mercy seat is amidst the wings. From the Quphah-Paúwah flows the gold for **the Mercy Seat** that is upon the ark.

Those that meet within the seat of mercy are those with the kindness and favor of the kuwahnim/priests which serve within the Quphah-Paúwah. Upon their lips are the Words of Life from the fruit upon the Tree of Lives within the Kephúw-Kephúw. In that the priests speak Life, and not death, all that come to hear their words turn their faces from anything vain. For should the priest speak death, then the people wane and are frail as the snails that melt from the fervor heat of the sun, whereby a shell remains, but the life within has dissipated. When the full revelation of the Body of the Shayh—the Mishkan—is set forth to the understanding within the eyes of YishARAL, all that is vain will never be looked at again, nor will any turn their back upon the House of ALOZAR. For as the full revelation of the Mishkan is set forth, all else that has ever been seen in the world will loose its luster and appeal, whereby none shall cast their eyes apart from the glory of AL. Within the ark are the two primary stones of HhaArúwan/the ark. The two stones within HhaArúwan are of the Tsædda-Tsædda Ring. Upon these two tablets are inscribed the Words of Fire/Shayin-Semek, whereby the Teuwrah is called the Law of Liberty. The inscription of the Ten Words is written upon the tablets of every mind when they arise unto the mountain of Enlightenment and prepare their minds to be One in the Spirit of Liberty. The two stones remain within the ark bearing testimony unto all of your members that they are called unto the covenant of oneness and freedom. Upon the ascent, the Breath of the Name is liberated. As the Breath is liberated from the skins of mortality, the Serpent of old unfurls itself, whereby the outer no longer has the force to retain the emerging strength under its sphere of influence. Those of the Stones of HhaArúwan walk in the freedom that pertains to those born as the Offspring of HhaALhhim. This is the age of transition within a Name, whereby one is transferred from the nature of a larvae unto the flying serpent. Upon the sides of the ark are the words that flow from the Tablets of Liberty, which are the writings of maShayh and Aharúwan. The words on the side of the ark are composed as one hears and unfolds the compound meanings within the Ten Words. **The hearing of the Teuwrah is based upon doing the commandments according to the Intelligence of Liberty.**

The **Table of the Faces—HhaShulchan Panayim**—is composed of the Rings of Tsædda-Tsædda and the Mæyim-Tæyth. These ALhhim meet with the kuwahnim/priests of the Quphah-

Paúwah Ring. The Bread of the Faces is for every six days and renewed on the shavbeth. There are two measures of Wisdom, two of Understanding, and two of Knowledge for each evening and each morning, for each evening and morning is comprised of two hours of Wisdom, two hours of Understanding, and two hours of Knowledge. The Bread is composed of the offspring of HhaALhhim—that is generated from the sides of their most perfect unions. Each seed, being the fruit HhaALhhim, is composed of two sides, a side around and a side within, even as a seed coat has an outer and inner lining. The side around is of Chækúwmah/Wisdom; the side within is of Bayinah/Understanding, through which all things are made. Through the union of these two Lights the House of ALhhim is built, whereby the sides are the Hhúwa-Uwah-Hhúwa, and the Rings being within. The Seeds for the evening offering are the inner and outer pairs in accordance with the Light of Bayinah. In this manner, all Seeds of the Trees and the plants of the field are either of the Light of Bayinah or the Light of Chækúwmah.

The Table upon which the bread is arranged is built by the offerings of Ayshshur and Maneshayh. The alignment of these four stones lays the four corners of the Table in which the Faces of YæHúwaH appear. Via the affirmations of Ayshshur and the every ready state of renewal in Maneshayh, the full expressions of YæHúwaH are composed. The complete and perfect expressions of the beaten grains, with the oil and salt, comprise the Bread. In that the Table abides in the north side within the Light of Understanding, the Bread is from Understanding, being measures of Wisdom and measures of Knowledge that come from Understanding. The union of the Tsædda-Tsædda and the Mæyim-Tæyth yield the bread of liberty and perpetual renewal. Thus the loaves are of the Bread of Liberty/Ayshshur and the Bread of Progression/Maneshayh, whereby there is no appetite for the bread of idleness.

We labor by WordBread provided daily. We perform our works within the four quadrants of the month, from shavbeth/shabbat to shavbeth. When we have eaten the bread of six days we are equipped with the Knowledge to enter into the shavbeth on the seventh day, for without the Knowledge of unity, we are not readied to enter into the shavbeth/sabbath ring, for the works of the Bread is yet to be fulfilled by our members. In accordance with the shavbeth offering, the Bread is arranged upon the Table for the subsequent six days. According to daily bread we perform the works of Light which give testimony to our abiding within the Rings from shavbeth to shavbeth. It is *not the bread alone that we live by, but by every Word of HhaALhhim, which is by the opening of the bread within the mind.* Though the bread is sweet and agreeable, we do not live by the Bread alone. However; **when the Seeds that are within the bread are opened, we then have insights into the Rings of HhaALhhim from which the Seeds have come. Hence, we live not by Knowledge alone, but by the Understanding that runs from the Seed as it is opened, whereby we perform every commandment by the Life of the Word that is within the Bread. The Life of the Word flows within our veins as every Word of HhaALhhim is opened, for as the Seed is opened, the blood that is within it flows into our veins, and by the Blood of the Word, we live and move and have being.**

The Breads of the shavbeth are arranged in pairs. The six pairs of Letters around and within are the offspring of the HhaALhhim that make up every loaf. The pairs are appropriated by the oylah offering of each day. For example, the ALphæh Bayit is a pair of Letters that belong to the ring around and the ring within of Wisdom, being the fruit of the Zayin and the Úwah. The

ALphæh Bayit is appropriated daily whereby the Word that is opened vitalizes the house in which it abides. The ALphæh is opened by the Light of RAúwaben, in the 7th hour, whereby the corresponding state of the Bayit, being the House of the eyes, becomes a dwelling in which the Principle is manifested in the eighth hour. From the morning offering, the Bread of the Faces are the ALphæh Bayit for RAúwaben; the Gammal Dallath for Shamoúnn [being of the inner ear]; the Chayit Tæyth for Gad [being of fruit upon the sides of the Kephuw-Kephuw]; the Yeúwd Kephúw for Aparryim; the Semek Oyin for Maneshayh, and the Paúwah Tsædda for Beniyman, whereby the Word is forever at liberty and does not become manifested in the flesh of corruption.

The flesh of HhaALhhim are the faces of the paired ALhhim and is not the flesh of the world which perishes. If you see the Flesh of ALhhim, then you have seen the fruit of the Tree of HhaALhhim. If you see one doing the works of HhaALhhim, then you have seen the flesh of HhaALhhim, and apart from the works you behold the rags of mortality.

Each cake of bread is according to the frequency of Light that may be eaten by our members. Shamoúnn is born of the Úwah Bayit Ring, and eats the bread of the inner rings of the Gammal Dallath, like a chick that is born within a shell and partakes of the inner food through which it passes through the veil of the outer shell. RAúwaben is of the ALphæh ring, but the ALphæh is partaken of within the Bayit, for through the body we partake of ALphæh whereby we know the full flavor that is within the Seed whether it is of bitterness or sweetness. Thus it is not just the Letter that is the bread of the Faces, but the Seed that is within all faces or expressions of thought that is the bread of RAúwaben. Gad eats of the Chayit Tæyth where the fruit is born upon the branches of the 12. Aparryim partakes from the Hand of Aharúwan the Words of Eternal Life, whereby the Word is blessed and expanded unto all the camps. Maneshayh eats of the Semek Oyin via which all transitions and progressions are made. Beniyman eats of the Paúwah Tsædda and thereby the faces of liberty are within every Seed of ALOZAR. These are the daily bread that is received each morning.

The bread of the evening are comprised of the Zayin Úwah. We commence with the bread of Wisdom for until we have the fear of Wisdom we do not have the teeth to eat the breads of Understanding and Knowledge. For Dan is the Zayin Úwah bread, for the tongue of oneness with two edges is given into the hands of the discerner. As Yididyah deciphers the mother of living from the mother of the dead, the decision was made by the sword of two unified sides. In this manner the Judge of Dan uses the tongue to conclude and resolve all issues. The bread of the Hhúwa Dallath is for Ayshshur, whereby the affirmations are made according to the illumination of the Mishkan. We affirm any matter whether or not it belongs to the Light of the Temple. Every matter to be accepted or denied pertains to whether it is of the clean of the Temple or belongs for the dogs which abide outside. The Neúwn Mæyim is for Nephethli, through which one meditates to draw out any thought and to become extended from one end to the other. The bread of the Lammæd Kephúw is prepared for Yahúdah through which all values and measurements are known. The bread of Shayin Rayish is for Yishshakkar. The works of our hands are performed by fiery thoughts, and if not, the works are dead and not of the Mind of Mashiyach. The Quphah Tsædda is the bread of Zebúwlan, whereby the lands that are given to reside in are filled with the faces of freedom.

According to the Bread of the Faces, the tribes weave their thoughts of Light to formulate the immortal and perfect deeds of the Teuwrah. Through eating at the Table, the camps are woven together into one fabric of unity.

The 12 Stones are what is called the “stones of witness” which affirm the Order of the Lammæd in the midst of YishARAL, and unto which we are aligned and move and have being. Around the Lammæd all bodies move, verses moving around the sun. From the sun or the loins one has movement, but the force that causes all to move is within the Lammæd.

The legs of the circles are united as fish-like in form, the tail ending in a horizontally flattened fin. The fin of the tail is the united feet that propel the body of united rings and spin through all spheres. The absence of the fin in mortals is due to the division in Yaoquv, which has resulted in a divided body with legs. The tribulation of Yaoquv commences in the loss of Yúwsphah and shall cease as all 12 Houses of Yaoquv are redeemed out of the hands of Metsryim and out of the hands of all nations unto which they have become servants.

### The Tree of Lives—The Origins of the Branches

The Staff is the foundation of the Tree of Lives. From the sides of the staff comes forth 12 branches. The Tree brings forth 12 branches, for it has 12 Heads within in, whereby it is the 12th Letter amongst the ALhhim. The Number of the Letter pertains to that which the Letter has within it, which is the value that it brings into the Assembly of HhaALhhim. From the midst of the 12, come forth the branches from its sides. In that the 12 pertain to the fruit of HhaALhhim, all Letters are in the midst of the 12, which is the Kephuw-Kephuw, the Tree of Lives. The value of Kephuw-Kephuw is  $11+11 = 22$ ; whereby all Letters have their Origin in the midst of the Lammæd. The sum of the Letters is 253, with a reductive value of 10, which reveal to us the Hand of YæHúwaH. The value of 10 is reduced to 1, whereby comes the saying that ALhhim are One—*ALhhim Achhad*. ***The unity of the branches upon the Kephuw-Kephuw is the basis of all Names belonging together as pairs, whereby only in Unity can we eat from the Tree of Lives and live amongst HhaALhhim.***

*Association of Names is the means to expand the branches of thought through which the garments of the qaviluth [those of the qabbalah], whereby what is hidden within paired Names is revealed. For how can the revelation amongst Names occur without there being a Union of Names which correspond to one to another? Through the union of the Branches of Names, the garments of the Mishkan are woven, whereby a Tent of Congregating unified parts appears. In like manner, through united branches on a tree, leaves as garments/coverings appear. The garment body of unified Names is made according to their united branches of Perfect Associations.*

The Lammæd/12 brings forth its branches in the midst of 5 upon the right side and 5 upon its left side, whereby there are 22 [ $12 + 5R + 5L = X/Taúwah$ ], whereby the sum of all within a Name is known. The 5 Letters upon the left are the means to draw out from the side of the Lammæd the branches of Understanding, and the 5 Letters to the right of the Lammæd are the means to draw out the branches of Wisdom.

In like manner, the 5 values to the left and the 5 values to the right of a Number/Letter, equals the Number in the midst when the sum of the sides is reduced. The Chayit/א, for example, being 8, has to its left: Tæyth, Yeúwd, Kephúw, Lammæd, and Mæyim; and to the right: Zayin, Úwah, Hhúwa, Dallath, and Gammal. Those on the left equal 55/1, and those on right equal 25/7. The sum of the parameter values, 1+7, equals the value in the midst—Chayit/8. This formula may be stated as the **Formula of the Kephuw/11**, and written as  $5+5=1$  which means that every Name is drawn out to bring forth its complete branching as Mashiyach. The Numbers on the left pertain to the Lights of Bayinah and those of Chækúwmah are on the right. The values that are emitted from Bayinah and Chækúwmah are the value in its midst of a Name, whereby every Seed Name is formed through the sides of Bayinah/O and Chækúwmah/W—OW. The Number of the fruit of a Name, which appears at its sides, is the Number of the Name. The lineage of a Name is also according to the properties of the Seed which is sown within the Rings of HhaALhhim and formed through the Lights. According to the Value that is sown, so are the Lights appointed to tend unto it, unto its full measurement.

Each day properties of the oylah lamb are drawn out through the Fire. The evening offering is the drawing out of Understanding; the morning offering is the drawing out of Wisdom. During the oylah/ascendant offering the Lights of the evening and the morning weave the thoughts from the oylah lamb, which form a garment at the end of each oylah. This is the weaving of the spindle to make the garments of Light. The Hand operating the spindle are Bayinah and Chækúwmah, the left and right hand that are at both sides of the offering.

The 10 Letters that surround the staff are the Counsel of the Rod and the Counsel of the kuwahnim and the Laúwim. Via the 10, pertaining to the two Lights/א of Bayinah and Chækúwmah, all ten lands are given to the staff for it to reside and flourish within. The five to the right and to the five to the left are the origin of the lands that belong to the Staff and to its Seed. The 5 Letters to the left of the Lammæd are Mæyim, Neúwn, Semek, Oyin, and Paúwah, and those to the right are Tæyth, Chayit, Zayin, Úwah, and Hhúwa, for the Kephuw and the Yeúwd are within the Lammæd. The value of the 5 Letters to the left is 75 with the reductive of 12. The value of the 5 Letters to the right is 35, or the reductive of 8. The sum of 35 is the Hhúwa/א/5 of the Lammæd/ל/30, whereby at the feet of the Lammæd is the Light [Tehillah/Psalms 119:105]. The 5 to the right are the radiance that come from the staff, whereas the 5 to the left are the Lights within the staff. The value of 8 (35) pertains to Chækúwmah, and the value of 12 (75) pertains to Bayinah. The values of those which gave to the Lammæd from the left are gathered together as One, being the Lights/א/5 of the 70/O [5+70], and by their giving they are known by their Number, which is their collective strength, rather than by their Names individually. The values of those which gave to the Lammæd from the right are gathered as One also, being the Lights/א/5 of the Staff/ל/30 [5+30], for these are those which emanate from the Lammæd. What is given to the Lammæd becomes its home; henceforth, they are called the Unified Lights [5+5] of the Chayit/8/Chækúwmah + Oyin/70/Bayinah, comprising a Body. This same Body is called Nachshun/נחשון, or the Serpent of Origin. The Name of Nachshun/נחשון is comprised of the House of the Neúwn/נעון in which is the activity of Fire/א. Nachshun/נחשון is code Name for the dwelling of ALOZAR, for within the unity of the sides of the Neúwn is 11/א [3+8]—which are the 1:1 ratios formed from the midst of the altar/א of Fire/א, whereby the Name of ALOZAR is the Words of Fire.



Lights of the Hhúwa/א+א within the staff, as they are numbered by Wisdom, are 10. From the staff come the Lights and the Breath that are within the Staff and every deed/10/Yeúwd/א that belongs to the staff. Those which gave of their Light became the space in which the Staff would reside. To the right of the staff is the sum of 35/8, which is the work of Chækúwmah. Hence, in the serpent, the staff would come to live, move, and perform its work. To the right of the staff is its head, being 75 or the Hhúwa of the Oyin—called the Lights of the Understanding, for both the Oyin, and the Shayin—the full extension of the Lammæd, would abide together at its crown. As the 5 to the left and the 5 to the right gave of their Lights, the staff opened to bring forth its branches of 12. The Lammæd/12 held nothing back, for it gave 12, the full measure of its Number. Likewise, as one gives the full number of their Name, they attain to their full measurement, which is Mashiyach within them, the expectation of glory!

At the base of the Staff are the Lights of Wisdom, and at the crown are the Lights of Understanding. These Lights are denoted by the overall consciousness of the Oyin/O in which resides the Hhúwa/א and the Shayin/W.

According to their perfect alignment as a staff, all of the ALhhim gather, and from their gatherings they go forth by the Staff, whereby all things are done by the staff [SYM/Ex 7:1, 10:13, 12:11]. **The staff is comprised of the Unity of the Rings of HhaALhhim, even as a tree is comprised of its rings.** As the offspring of HhaALhhim we also form the staff as we unite all spiral thoughts into one accord from end to end—ARAL.

According to the staff we gather and we receive the instruction of the Túwrah. By the staff we go forth according to the instruction that is imparted unto us. From the gathering of the ALhhim comes the right of the Assembly of Names, unto which all that are called by AL gather together upon the Shavbeth/sabbath for the Readings of maShayh—for the impartation of all drawn from the sides of the Lamb [Maoshah Shlichim/Acts 3:21-24;13:27; 15:21]. All of the ALhhim come into the Kephuw through which the fruit of the Tree is formed. From that which in their midst the ALhhim and their Offspring partake of the Fruit of Eternal Life. As they congregate, they give unto each other, whereby they learn from each other. As they give of their Letters, words form from the gatherings even as words forms from the arrangement of the branches for the oylah each evening and morning. From their gatherings in the Kephuw, they march under the direction of the staff. The staff is the bar upon which 6 branches are on one side and 6 branches on the other, which are the 12 Houses that abide within the Staff of AL. The 6 pairs, together with the Ring of the Lammæd-Yeúwd, are forever the 7 Rings of Aúwer/Light.

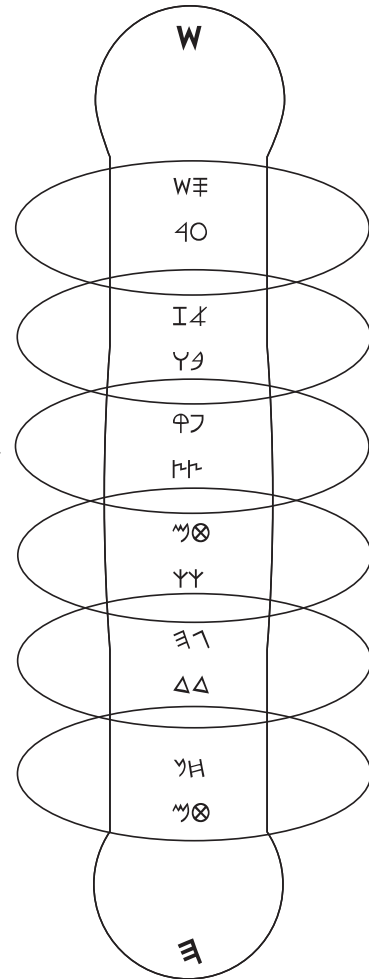

The congregation of AL, being the HhaALhhim—the 12 Houses of the Lammæd/12, known also as the Assembly of the Firstborn.

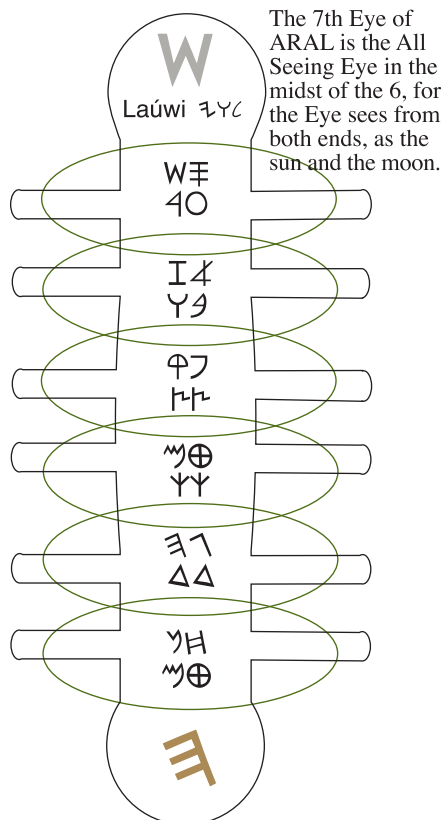

The 7th Eye of ARAL is the All Seeing Eye in the midst of the 6, for the Eye sees from both ends, as the sun and the moon.

The congregating of the 6 original Rings of HhaALhhim. These are the pairs of the three rings within and the three rings around. From these Rings, come the value of 54, which interpreted is the Path of the Neúwn. As the Rings merge, they bring forth the fruit upon their sides—the Tayit/9. The value of  $6 \times 9 = 54/\Delta$ .

The illustration of the Tree of Lives Origin show the position of HhaALhhim as they are arranged amongst themselves. The Shayin-Semek is at the top and the Mæyim-Tæyth is at the base, whereby the Fire of Dan resides at our crown, and the wells of Maneshayh at our foundation.

As the Household of AL congregate in pairs, as a Fabric of Joint Names, they bring forth fruit from their sides. The fruit of HhaALhhim are the Names that appear within the Branches. From these paired Names comes the 12 rods of the Tribes, which are the Number of the Staff. According to their position within the House, they are set in the heavens, as stars which is according to their dwelling around the Mishkan. As the staff is set into motion, fruit upon its sides are set into their lands for full expressions of glory. The motion of the staff is the story of the Sower of the Seed, whereby each Branch of the Staff is sown into the Lands of their inheritance.

The 12 fruit have within them the Seed Dan is formed by the Union of the Pairs of HhaALhhim, whereby their fruit is 6 in Number, which displays the Seed of AL from which they are born, being 7 Seeds. The seventh Seed is formed of the Union of ARAL and HhaLaúwim, for they are One House.

From HhaLaúwim all branches come forth unto the lands appointed for them; however, the Laúwim have no lands, for they abide within the House of AL which is their inheritance.

**As the Staff begins to bring forth its Faces, it replicates itself, in the Branch of Maneshayh and Yishshakkar.** *The staff of Yishshakkar and Maneshayh is the staff/stave [cross] that everyone is to take up daily, for this is the Order of your Name upon which your members are hung.* The Hand of Yishshakkar is the Hand of Aharúwan, as the Hand of Aharúwan is the Hand of AL. The Hand of Aharúwan is set first in the Mind of AL and then Maneshayh. As AL is to AR so is Yishshakkar unto Maneshayh. Within every deed of Yishshakkar is a transition—Maneshayh; hence, **the deed is set first in the formulation of every commandment, and then the transition follows.** The fruit of every deed has within it the results, therefore, Yishshakkar and Maneshayh are set together as AR and AL, for AR is in AL, and AL does not appear without AR, nor can any appear without their Name being bound unto another in Light. Therefore, every pair of branches upon the Tree of Lives is spoken upon the evening and the morning of each day; and the morning is within the evening and the evening within the morning. For what comes out of an evening meditation is an observation in the morning, and what comes out of an observation has within it a meditation. According to the evening and the morning of everyday, so are the tribes set within paired months. What is spo-

ken in the evening appears 6 months from the utterance, even as what occurs in the first hour of the evening oylah appears in the seventh hour of the morning, as it is spoken by the awakened mind in the morning. Likewise, what occurs in the first month, is harvested in the seventh, the seventh being the same as the first, by what is sown in the first is reaped in the seventh.

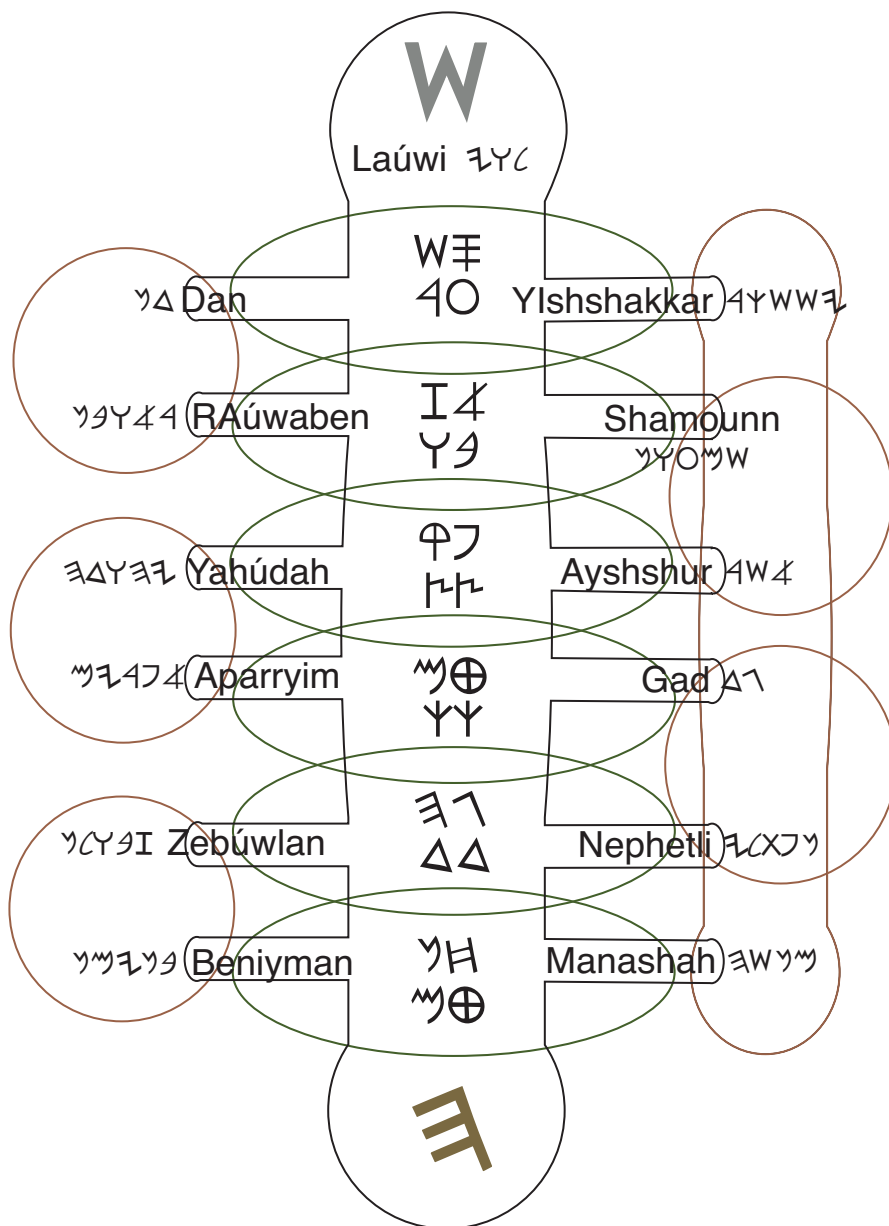

The Tree of Lives—meShiæch and the bearing of Ayish through which the fullness of AL and meShiæch are known as Seed of AL fills the Lands/spheres of Aúwer/Light.

**The Tree of Lives Origins.** Branches of Lammæd, known as the Offspring of the Laúwi, abide within the Body of the Shayh. From the pairs of Branches, comes forth the fruit from their sides, from which all Names of HhaALhchim are formed to be born in their day of appearing. The Lighting of the Menurahh is unfolding the Tree of Lives each evening and morning. The Menurahh folds upon itself as the sun and moon sets and then is fully opened in the midst of each evening and morning.

*The replication is the means of branching forth the pattern of AL, whereby every Name that comes forth from the Tree of Lives carries within it the Staff of ALOZAR. Through the staff or your Unified Names, all bear the fruit of their Names united. The staff of Maneshayh and Yishshakkar appear on the right side of the Tree, denoting that it is birthed from the midst of Mashiyach. The Staff is of AL; the fullness of the staff is Mashiyach, which reveals all that is within in the Mind of AL. As the staff breaks open from its midst to bear its fruit, the full measurement of the Tree is drawn out. The full traits of ARAL is the complete expression of Light, which is Mashiyach. As the full measurement becomes opened within every House, every Name is released to reveal the full glory that is within the fruit of AL. Those that belong to the Fruit of AL are of the Assembly of the First-Born, for they also bear the image of Mashiyach within them.*

*MeShiæch is called “the unique one” or “the only begotten of AL”, for there is no other born of AL except only begotten ones. All born of AL have unique traits of Oneness, whereby they are known to be the only begotten of AL, for AL does not bring forth any that do not have a complete expression of ARAL within them. Those who have traits of AL do not sin against the Divine Order, and it is not possible that they sin. But that which is not born of AL errors until it is corrected by the Mind of Enlightenment, whereby it is redeemed from the nations and brought to full disclosure within the Name of ALOZAR to belong unto the Unified Kingdom of Light. In that Mashiyach, and all that bear the Name of Meshiæch, are born of AL, AL is said to be the Head of Meshiæch, whereby Meshiæch is the head of Ayish (man), and Ayish is the head of Ashayh (woman). The Head is that which cometh forth from another even as the head of a plant comes from the body of the plant. AL cometh forth from AR. Meshiæch comes forth from AL-Ayish. Ayish comes forth from AL-Ashayh—the Virgin Consciousness between two, that determines space in which one may flourish. Let not the reader think that the order of headship speaks of bodies of mortality, for AL nor Meshiæch will put their Head upon a body that is not of their Word. For in Meshiæch there is no male or female as in mortals; hence, how can one say that the man and woman of corruptible flesh are formed through Meshiæch, when they are not within Meshiæch, for none can bear upon their branches a fruit that is not of the Seed of their Name. As an apple tree cannot bear a peach, so mortality and its division cannot be born of Meshiæch—the Master Name of Consciousness/Yahushúo/OWYאב. Nor is there slave and free in Meshiæch, for all are at Liberty, whereby one is not the master of another, but all are servants unto each other.*

According to the opening of the Word of AL, so the Tree of Lives bears its branches and its fruit. **The Word of AL is the Seed of Light.** When the Seed Word is opened, the full traits or full measurement appears, which is Meshiæch. As the fruit of full measurement gives of itself, every Name that is within the Seed of Life appears. Each Name is born from the Tree, in the House in which it is formed—where it is planted to grow unto its full measurement, unto the likeness of Meshiæch. For one born of Shamoúnn abides within the House of Shamoúnn, whereby it comes to its full measurement. The body in which the Tree appears is **Ashayh, which is the Body of the Lamb.** The Body of Light is comprised of Chækúwmah and Bayinah, through which the Meshiæch and the branches of Meshiæch appear. Though we are born from the Body of the Counsel of Oyin, the Unified Name is the Head which arises within the Body—into the Oyin. In the consciousness of their Union, the united Names reside and become the

Head of their branching, so is ARAL the Head of Chækúwmah and Bayinah—the Body of their perfect Union.

**The Body** that one loves as its own is not the body of this world, for it shall perish. **Rather the Body that one loves is the consciousness that is woven by the paired threads of Light amidst two united Names, which is the Body of Shúo/OW.** This is the Body formed of the Lights of Chækúwmah and Bayinah, woven from the sides of those unified. The Sisters in the world are holding a space for the works of Wisdom and Understanding to be accomplished in all souls that are passing through this realm, for they are, in their hearts, the servants of the Virgins. Through the Body of Shaúo/OW all are formed and born to reveal the glory of their united Names. i.e. The rod between Aparryim and Yahúdah is the wand and the staff that weaves and forms the Body of Meshiæch in which their Names dwell. Through, Aparryim and Yahúdah, all things are manifested, for all things appear as values are expanded/blessed. Though the Words are set for the heavens and the earth in day one, the earth does not appear until the third day. Thus what is spoken appears in the third day—the Day of Knowledge, whereby the House of Knowledge—Beniyman and Zebúwlan, sown on day one, appears on day 3. All Fruit of Knowledge, being the Body of Wisdom and Understanding, appears upon the lips of the kuwahren/priest, as the Seed arises and forms a head within the Mind of Enlightenment.

All Names and thoughts are within the Head of AL. Hence, the garden of all Names is the Garden of YæHúwaH—Sudúwm and Gomarrah/גִּמְרָה, which is the Garden of Oodænn/Eden/עֵדֵן at the level of Knowledge. Both gardens, Oodænn and Oomarreh, are the structuring of the Oyin. In their midst is the Vineyard of Núwach, from which the planting of all Names come forth; for the garden of Núwach is the House of Beniyman that builds itself an ark—being a Body of three levels, whereby the flood from beneath—Wisdom, and from above—Understanding, lift the Seed to the tops of the mountain—Knowledge.

With the staff is the setting of the Seed of Beniyman, whereby all that comes from the Staff of AL comes through grace. This is the fruit that bears first from the Neúwn-Chayit Ring—the fruit of Beniyman. As the staff rotates, the Seed of Beniyman brings forth the fruit of Zebúwlan, even as a Seed brings forth a River of Life in which it dwells, so is Zebúwlan the River in which the Seed abides. Hence, Beniyman is set first and then Zebúwlan, which springs out of the wells of the Hhúwa-Gammal Ring of HhaALhhim.

From the setting of the Seed, that is born from the Staff, the Heart is formed to bring forth all of the Offspring within the Seed. The heart is Laban, from which comes the Body of the Light, formed with the four chambers of Liah/Leah, Zilappah, Belahah, and Rachal. The Body of Laban means a whitened dwelling, through which we activate all that is within the Seed. Out of the Seed runs the River of Life—Nephtli, that carries the Names within the Seed unto their place of service, for whenever a Seed is opened, the blood of the Seed runs from it into the land into which it is sown. By the blood, the Seed planted rises unto the pattern of Meshiæch, to which the staff and its work/fruit belongs. With Nephtli is Gad, whereby the words within the Seed are opened upon the Altar. As the words are opened through the sacrifice in Nephtli, they give their Light unto the opening of the Eye, through which all is forever changed within the Mind that receives of their Understanding. Only through the opening of the Word are we

changed, whereby there is a twinkling of an Eye. All Seven Eyes of HhaALhhim shall flash the Light unto our Minds, whereby our hearts are turned unto the ALtar of AL through which we may enter beyond the hangings (veils) into Lammæd Yeúwd Ring of AL.

The *Qudash Qudashim*/Holy of Holies is where the Staff resides, for in that all has come from the staff, it is consecrated by all that has flowed from it, whereby it is said to be most holy, for from the Staff has flowed the River of Life, and unto the Staff shall all return. The space to the Faces of the *Qudash Qudashim* is also holy, for it contains the Life that has flowed from the Seed of the Staff. In like manner every plant is a holy body for the Seed from which the plant grows; however, the crown of the plant, in which the glory comes to reside is most holy. Therefore all who are of Understanding will honor the House of YæHúwaH, and the Body of the people called by the Unified Name, and the place unto which they shall place their Seed, for these are the spaces in the Lands where the Name of YæHúwaH has been set, and it is *qudash* in our Eyes. No one of Wisdom shall sow their Seed into lands that are not of the Body of this Union, but as every Teaching yields a fruit, so are the Seeds to be sown into a Body of Light. Even the Words that we speak are sown unto Righteousness for the sake of bringing forth the fruit of YæHúwaH. We are not as the dogs which return unto their vomit, for so are they who return to eat of the flesh and drink of the cup of mortality from which they have been called unto a new land.

In conjunction with the Seed opening comes the fruit of RAúwaben, for as the Light strikes again the Seed of a Name, the Eyes open. With the opening of the Eyes is the House of Dan. With each opening of the Seed, the blood of Dan, being Nephethli, begins to run, whereby the Eyes of HhaALhhim open one by one. In this manner RAúwaben, meaning to see, is opened, for by the blood of Dan all of the Eyes of HhaALhhim open, each in their order.

The Seed bears from its midst first, and then from its base unto its crown. According to the Meshiæch, being the Seed, Beniyman is the first born from among charvim/comrades. When Beniyman appears, the brothers who uphold one another in the Light are able to ascend, as a plant that rises from the opening of the Seed. Though all are present in Yaoquv and come into Metsryim together, Beniyman is brought forth foremost. Through the birth of Beniyman we pass from one world unto another, from an aúwt to a muód/age, and from a muód/age unto an aúwt. For an aúwt contains the works of Understanding, and a muód is the harvest of Wisdom unto Knowledge. When all that Understanding has been sown is reaped, then the aúwt and its muódim are complete. Likewise, when all that has been reaped from which has been sown in mortality, then the end of this muód shall come upon us as birth pains with great travail [Chazon/Rev 12].

With Beniyman are the stones of Maneshayh, and with Beniyman is Zebúwlan, whereas with Maneshayh is Yishshakkar. Though Yishshakkar is seated first in the mind of AL, yet one is not able to perform the works of their Hand until they are first ushered into the space for which their Name has been appointed to dwell. Our dwelling is determined by what is allotted into our hands through the forming of the Lights of Bayinah and Chækúwmah. Hence, it is imperative that we lay out our inner members daily under the Lights, that the full measure of our Names may be reached. In that each member is dependent upon another, so **AL has**

**arranged the Branches that none can consider that they are more important than another, nor can anyone move without the other. All Names are woven in a Body of Unified Names so that there is no division within it,** for all are given honor as to their place, in order that the Body is whole and secure. The Deeds of Yishshakkar are in the Mind, whereby their Body, being of Maneshayh, and the means of transition—is given to the Priest—to the Enlightenment. **The One that performs the deed is given the chariot of AL, for every transition comes by doing the commandments, and via the chariots of Maneshayh we are carried about from the Body of our deeds** [2 Melachim/Kings 2:11; Yaoquv/James 1:19-25]. Through the Body of Maneshayh, the Priest light the Menurahh and likewise sound forth the trumpets over the offerings of Beniyman, whereby all of the camps set out together and make their transitions through Maneshayh. Every movement of the staff is a result of their deeds performed according to the Teachings of the staff.

With the opening of the Seed of Beniyman, the Branch of Nephethli appears which carries the perfect ratios within the Seed unto the ALtar. With Nephethli is woven Aparryim through which the Thoughts may expand. With Aparryim comes Gad and then Yahúdah, for the values within a Word do not appear until the Word is opened by the blessing of Aparryim, that serves as the tongue for Gad. With Yahúdah is Ayshshur, for when the inner truth expands, the evidence comes forth as the sound of the shofar to affirm it. Hereby is the truth sounded forth within the Rings of HhaALhhim. Via affirmation, the Eyes of RAúwaben are opened out of a deep sleep, and with RAúwaben is Shamoúnn to give comprehension to all that is seen. Via Shamoúnn the depth of a matter is revealed, whereas with RAúwaben, the full consciousness of a matter is known. The eyes that look intently within the Law of Liberty shall hear the Voice of the Lamb/Shayh, but the one who looks upon the Law as that which pertains to this world, reads the Words as one bound unto their self-projection; such shall be filled with confusion. With Shamoúnn, and only by comprehension of a matter, comes the Judge of the House, for until then there is not the wherewithal to make a decision, lest it be made in part. At the end comes Yishshakkar—the Head of the Staff, who appears again through the Deed to which each Name is appointed. For what one bears in their hands, even their deeds, shall rise and judge them. Those deeds that are unto Life shall appear in the hand of the one that performed them. The deeds unto Life shall have within them Life which leads unto the course way of Life Eternal. In each pair of Names are the Works or the Deeds unto which they are assigned. Therefore, at the end of the age, everyone shall be known by their Name, for in their Name is Yishshakkar—the Work of their Name. As the Left Hand of the Judge, Yishshakkar implements into deeds what has been born out of many waters—the waters of baptism in the kaiyúwer/laver, being thirteen in number.

**Herein are the Branches of a Name that stem from the Right Hand of Beniyman unto the Left Hand of Yishshakkar.** The ones born of the Staff of Meshiæch are those of the Assembly of the Firstborn which have received from the Hand of Aharúwan, who is forever in their midst, and from whose Hand all is given. By the Hand of Aharúwan the staff turns, whereby the fruit ripens to be born. The birthing of the branches is not the same as the forming of the thoughts out of which they appear. *The birthing is their appearance, but the forming is how they come into the Body of Light from which they are birthed.* The forming of the branches is within the Body of Laban, as stated in the Teuwrah [SMB/Gen 29:31—35:29]. The one formed

last—Beniyman—is the first that is born, for none are born until the Seed is formed. When the Seed is formed, then all that is within the Seed sprouts forth, whereby the 12 appear and are called “the planting of YæHúwaH.” **The planting is of a Collective of Names that are as one in the Hand of YæHúwaH** [SMB/Gen 42:13/Yeshoyahu/Isaiah 61:3].

Those who say: אֶחָד אֶחָד אֶחָד אֶחָד אֶחָד אֶחָד אֶחָד אֶחָד אֶחָד אֶחָד אֶחָד אֶחָד “*Achim Anachnu Benay Ayish Achadd*”—We are brothers—the upholders of one another—the Offspring of One Ayish, are those who may come into the Tree of Lives. For until this confession is made, the members of your mind are separated from Yúwsphah from whom the blessings of the Tree come. Until their members are unified to uphold each other in the Liberty of Meshiæch, one dwells in their definitions with a Pharaoh that does not know Yúwsphah. Each plant is known by its leaves and its fruit, but the Tree of Lives is known by its 12 fruit that are born upon one Tree, whose leaves do not wither and whose fruit comes in its season.

Planting of the Trees of the Associatives is not done in the day of Adim, but follows thereafter when there is first a caretaker of the Trees [SMB/Gen 2:4-5]. Thus the branches of a Tree are not to be born from within a Name until there is an awakened Name that will care for them. In the midst of the awakening, the Trees of Knowledge are now being planted as the tribal members are set and joined as the branches of the Kephuw Kephuw. The 12 are not called until there is a Master that will guide them. In the appearance, which is their birth, the tribes are restored unto their habitation. All things must be restored, and then the end shall come [Maoshah Shlichim/Acts 3:19-26; Romans 8:18-23], for until the end corresponds to the beginning, there is no moving forward. The restoration of all things is according to the Mind of AL, then the body will be forever immortal and arranged in ARAL. The end of this muód cometh fast upon us, wherefore we are to be alert with watchfulness and prayer and are to be engaged in every Deed of the Light, having no part of darkness. For by the deeds of darkness the soul slumbers in the graves of the gentiles. Let us labor with travail until the Meshiæch is born from amongst our chavarim, whereby they shall be redeemed from the corruption of the world, for the Kinsman Redeemer, who is our Priest, now comes with the silver to redeem all that have gone astray from the Rings of ARAL.

The fruit of Dan is from the Seed of the Shayin-Semek, the inner and outer coat of the Seed. To each Name is given a Name to bear its Seed, whereby the glory that is within the sides is revealed. The fruit of RAúwaben is from the Seed of the Zayin-ALphæh. The fruit of Yahúdah is from the Seed of the Quphah-Paúwah. The fruit of Aparryim is from the fruit of Yúwsphah, the Mæyim-Tæyth. The fruit of Zebúwlan is from the Seed of the Hhúwa-Gammal. The fruit of Beniyman is from the Seed of the Neúwn-Chayit. The fruit of Yishshkhar is from the Seed of the Rayish-Oyin. The fruit of Shamoúnn is from the Seed of the Úwah-Bayit. The fruit of Ayshshur is from the Tsædda-Tsædda. The fruit of Gad is from the Seed of the Kephuw-Kephuw. The fruit of Nephethli is from the Seed of the Dallath-Dallath. The fruit of Maneshayh is from the Seed of the Yúwsphah, the Mæyim-Tæyth. These are the fruit in which are the Seeds of AL, whereby we partake of the Trees unto Life Eternal. The deeds are the fruit which have the Seed of Maneshayh within it—Beniyman, the Right Hand. The fruit of a Name gives testimony to the Order of the Lammæd to which they follow, and those of AL follow not after the staff of the stranger, nor is their voice heard in our camps.



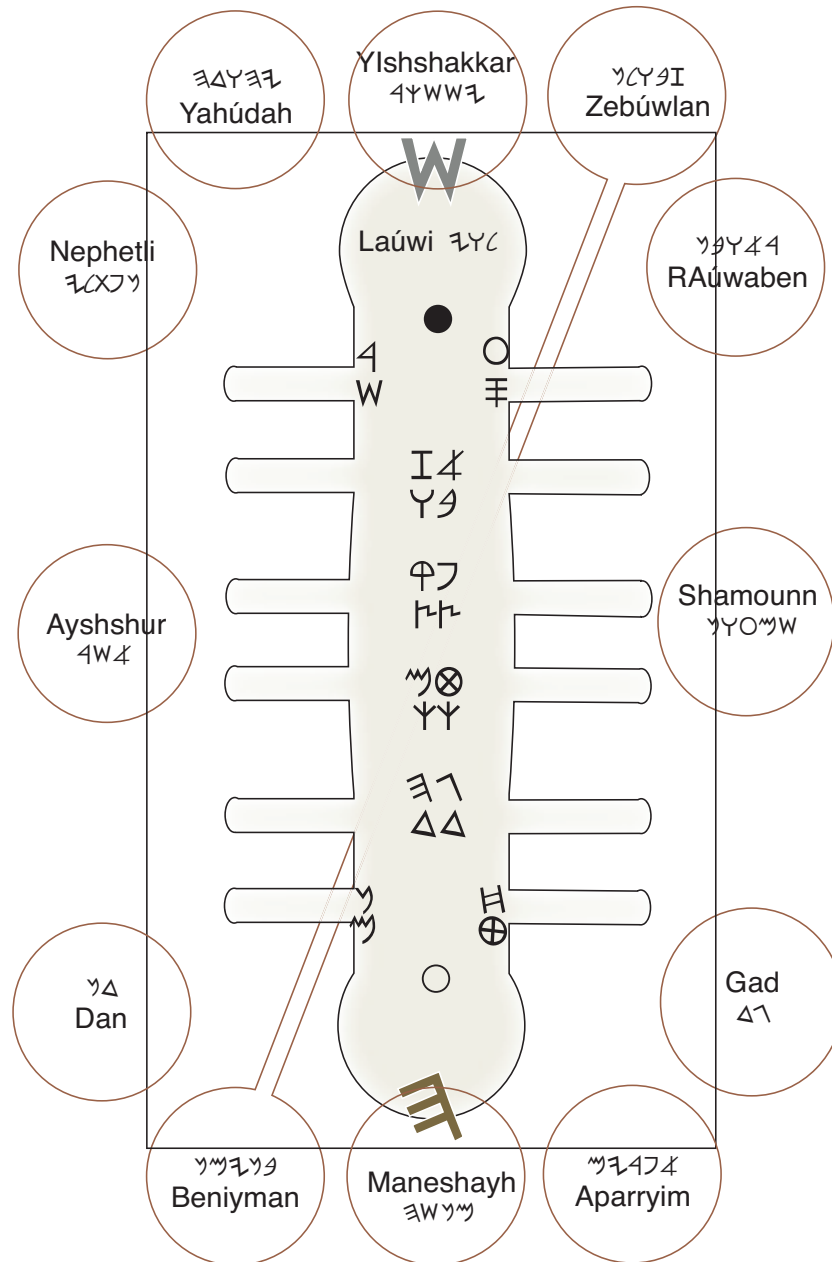

The Staff of a Name and the arrangement of their 12 branches form the Mishkan, and take up their residences at its sides. The inner core, from which they come forth, is the pattern of the Manurahh housed in the ribcage.

The Setting of the Stars is the Rising and the Placement of the Branches in the Fields of Knowledge

Kephuw Kephuw is 11+11, which are 2 sides of Tree of Lives, with the sum value of 22. The Tree of Lives is the Union of two living Names, each a side of the Tree, as the Kephuw/ץ.

The Tree of Lives is the Assembly of Names, so arranged side by side that they bear the precious fruit which is the expressions of their Unity. The branches of the Tree upon each side are depicted by the Letters of Origin that come from the sides of the Lammæd/Staff. All of the ALhhim are of the Tree of Lives, being branches of Meshiæch. Though the Tree has the value of 22, yet within the Tree is the value of 10. Ten is the reductive value of the sum of face value of the Letters added together, which comprises 253/10/1. Hereby comes the saying that the works of the ALhhim are One—the perfect state of unity. From this formulization, comes the saying, HhaALhhim Achadd/God is One, even though the Nature of ALhhim is Twelve Pairs.

The 11 are inside the 12 as the Kephuw is inside the Lammæd. Therefore, Meshiæch, being the Tree of Lives, is within the instruction of the Priest, being within the Lammæd/Rod of Aharúwan/Aaron, which is the Rod of AL administered by the Hand of Aharúwan. The hands are within the Lammæd, and they come out from the sides to bring forth the deeds and expressions of Perfect Unity. Therefore, from the priests' hands, come the commandments which order/arrange the souls to bring forth the complete Faces of HhaALhhim in their Names.

Within the Unity of Branches, the ego has been smashed, whereby the perfect expressions of Light may become evident. The ego is the imposition of thought upon the Mind that is layered upon the soul, thereby affecting the level of radiance and the expression of the Inner Name. The ego is comprised of views and attitudes that are imposed upon us, including the ideas of success in mortality imposed upon the next generation to maintain mortality. The perceptions of the former generations have been woven into the cultures of the world, which are being smashed, never to rise again.

Having the ego smashed and ripped asunder, as a garment that is worn out, the Kephuw Kephuw becomes the true identity of Name through which the branches of light bring forth the fruit of Life. Each fruit upon the Tree of Lives has the Seed of HhaALhhim, and this Seed is within our Branches of Name.

When the 6 Days are fulfilled, another aúwt/epoch may be entered into. An aúwt is completed within the Directive Consciousness which is comprised of the United Minds of the Neúwn. The generations of HhaALhhim have come through the Age of Adim and have entered into the Age Avrehhem. These two ages are the two ends of the aúwt of Nuwach/Noah. Each aúwt has two muódim/Ages, the former and the latter. This distinction is also made in the ages of a tree. There is the former age, in which the tree is planted and its Seed begins to open. The opening of a Seed is like the sending forth of the Life within the Seed. Hence, there are Adim and then the sending forth of all within Adim, which are the Days of Avrehhem. As the tree brings forth its branches, it enters into the second age, known as the latter. In the aúwt of Nuwach/Noah there is the Age of Adim/conceptualizing, to initiate an expansion, followed by the Age of Avrehhem, which is sending forth that which is within the Seed unto the Days of Yaoquv/Meshiæch—the reaping/harvest. Each Age has many Names and Days of progression through which it is fulfilled.

## The Hours, Degrees, and Twinklings of the Eyes are Determined by the Oylah of the Fire

Each measurement of progression is the value of 10. A full progression has the value of 30, which is the number of the Staff/30. According to these values/measurements, the months are three tens, for each month is the work/10 of Light according to the Staff/30. As the root of the staff is 3/Gammal, so its works are of three: Wisdom, Understanding, and Knowledge. As this computation of values is the structure of each month, and each month being derived from either an evening or a morning of a day, so the full measure of a day is three tens doubled or the value of 60/¶—the structure of the united Branches. Semek/60/¶ is the number of kevashim/lambs offered during the month, two lambs for each day [Chamesh HhaPekudim/Numbers 28:3]. A week is 7 Semek/60/¶ or the value of 420—the complete days/activities of the Semek. What is the Semek? Semek/60/¶ is the inner structure of Fire/Shayin/21/W, even as 6 parts are within 3, so is Semek within Shayin. Hence, a week is the fulfillment of the Fire upon the Altar that does not go out. The relevancy of days, weeks, months, years is that which is within the Fire of YæHúwaH. A month is 30 days of 60, being a value of 1800; a year is twelve months of 30 days, being a value of 21,600—a value that contains the combined values of Shayin/21 and Semek/60, which are **the number of paired degrees in an evening and in a morning**. For nothing is counted unless it is paired/joined, for if one part stands apart from the whole, then the sum cannot be known, for how can we know what is in an evening without the morning whereby we observe it? Within a day are 12 hours. *Each hour contains 60 degrees—windows of observation. Within each window are 60 twinkles of the Eye.* Within each window or degree is the value of 60, even as there are 60 minutes and within each minute is 60 seconds. 12 hours x 60 degrees x 60 Twinkles of an Eye = 43,200, a doubling of 21,600. There are 6 hours of Understanding/evening and 6 hours of Wisdom/observation. These comprise the two sides of a day; within each side is the value of 21,600 [6 hours x 60 x 60 =21,600]. In accordance with the two sides of the Lammæd so are HhaALhhim arranged. The value of those on the right side number 114/6. Those on the left side number 150/6. According to the Number of HhaALhhim so are their 6 hours of Understanding and 6 Hours of Wisdom. Within the 6 are 12 for within every Union/6 is the Staff that upholds them as One. Within the 12 are 60 for within the Lammæd/12 are the united Branches of the Semek/60. Within the 60 are 60, for within every position of observation the eye may twinkle to comprehend that which is arising from the 12 parts upon the altar of sacrifice. Even so, do we come to know Meshiæch through the Offering that is made upon the Staff/Cross.

Hours, degrees of observation within an hour, and the twinkling of the Eyes within an observation, stem from the structure of the oylah offering. The paired branches are 12 for they are of the pattern of Meshiæch, the Lammæd Branch of AL. Within the 12 are the 60 which are the number of the offerings of the 12 branches as they are arranged within a month. As the Fire Breathes, the offerings are consumed. With every full Breath—an inhale and exhale—the works of the offering are revealed/manifested. In accordance with the offering, so are there 10 full Breaths within every 30 seconds, for within each side of the Staff/30 are the hands and the works of the staff, being 10. Hence, one may say deduce that there are three in one; however,

we know HhaALhhim to be 12, whereby the full stature of Meshiæch is attained. The core value of Semek/60/𐤌 is the two sides of the Staff/Lammæd/30/𐤌, whereby the inner structure of the bones, as the skeleton, is comprised of two sides, being a formulation of the Semek/𐤌. The Lammæd/12 is the wand of Fire, being the inner pattern of the Shayin/21. The radiance of the Fire is 21, the source of the Fire is 12; the root of the Fire is Gammal/3. Without the opening of the neck/Gammal, the inner wand does not come to blaze unto the Shayin; even as without the sacrifice of the daily lamb, the inner staff is not orientated with the movement of the priesthood of AL. It is only the offering of the daily lamb that gives meaning to the transactions during a day; for without the offering to YahuWah all transactions are meaningless, even though one may pretend to have meaning and substance in what they are doing, in the final analysis, the value will vanish as the world.

Combination of the Fire/21 and the offerings/60, being 3 and 6 respectively, is the value of 9, which denotes the value of the Fruit that is born upon the branches. The Fruit of the year, denoted in the value of 21,600, is essentially the fruit that is born upon the sides of the Branches, which are 9/⊕.

**The organization of the Lammæd** bears upon its sides the full House of HhaALhhim, and likewise does every pair of Names bear upon their shoulders, the full Nature of HhaALhhim. To bear the Rings of the Tree of Lives, and to bear the Faces of Immortality, is taking up your cross/staff. The ideas that one carries within them and the deeds that are upon the sides of your tree is the baggage of what one is bearing upon their shoulders. Only the thoughts and deeds of Unity—being a paired value of six—of joyful expressions of Light—are born upon the Tree of Lives. These pairs of six come from the 7th, which is never seen, nor will it manifest itself in the skins of mortality. Though we carry Words of ALhhim—the Strands of Aharuwan, upon our tongue, and though they are written within us, they remain transparent to the undiscerning eye, through they come to reveal themselves in flesh.

Within **the organization of the Lammæd** there appears the values of 1, 2, 3, 4, 5, and 6. The 6 branches of thought pertain to the six days, which provide the pattern of all unified acts. These 6 days are within the arrangement of the spaces that appear on the each of the faces of the cube. Should one fold over the north side of the Letters (in the above chart) to be beneath the south side, one may then see how the days of Wisdom are upon the face of the cube, and the days of Understanding are within the cube, for each of the 4 weeks during a month. The fourth level of each month is comprised of the Taúwah that appears as the crown of Understanding upon each of the 7 columns.

## The Days, Weeks, Months, Years, Ages, and Aúwtut/Epochs

There are 12 hours within a day, but a day is 10, comprised of the Light/5 of Bayinah and the Light/5 of Chækúwmah with Staff of ARAL in the midst. Hours denote functions of Light within a side of Light. Days denote activities of Light from two ends. Twelve weeks comprise a season, and within a season there are 12 shavbethuth/sabbaths. Each of the 12 Houses gives of the Lammæd for the season of its fruitfulness.

In the months there are three 10's—according to the measurements of the mincha. Months denote the works of the Light that yield fruit—corresponding expressions to a thought. In a year there are 10 10's—the complete extension of the Hand. Years denote a process a study through all 12 houses. When every branch has formed its fruit, a year is counted. **A year is the same thing as the 6 Days of HhaALhhim, for the twelve months are each an evening or a morning of the six days.**

A Muód/Age is 100 10's—the extension of a dominion. An Aúwt/epoch is 1000 10's—the full extension of a Premise. An aúwt or era, is a dispensation of Light out of which comes a new state. Within each era are two ages for the former and the later rains to initiate and to fulfill an era. In the Aúwt of Núwach, there is the Age of Adim, the former, and the Age of Avrehhem, the latter. A day or 1000 is the same in the mind of ALOZAR, for each is an activity of the Light corresponding to an ALpha and the Staff within the ALphæh. Therefore, each day is complete in the mind of ALOZAR for it is a work of Light. The Light has no end nor beginning in that it is always within AL and goes forth from AL and returns unto AL.

There is no anxiety regarding time, for who we are in each other is the means for us to engage in the ALphæh Lammæd. We are eternally in the Fabric of ALOZAR, woven as united threads that do not wear out. We do not consider the age of a man to be counted as anything, for to do so would reduce the properties of thought to a mortal form that perishes, whereby the age counted would be foolishness. More so, we are not to say we are of this mortal age, for our measurement is not according to the darkness of mortality.

A Shannah/year is a complete study. To say someone is 30 indicates that they are of the study of the Staff or that they have completed 30 studies. Each study is made from all 12 houses/degrees of Light, whereby it is one year. None are counted in YishARAL until they are of the Kephuw, for until they have the value of 20 they have yet to be paired, whereby they come to have an allegiance to the Staff; hence they are not known as YishARAL, but as fledglings.

When Year of 50 are attained in both Wisdom and Understanding, an new aúwt/epoch is born, for now 100 10's have been completed. An aúwt has its own space, form, and Name. The aúwt that we are in now is called, Núwach, which is set up to expand the Principles of AL. Hence, prior to the aúwt of Núwach, there was a previous aúwt in which the ALhhim formed 7 Eyes; hence this aúwt is called after the Oyin.

From the aúwt/epoch of Núwach, we enter into the aúwt of Yetschaq. Every aúwt comes from the midst of the muódim/ages, even as the next full month comes out of the midst of the current month, and a day come from the midst of its evenings—understandings. In this manner, the needle is woven from one side unto the other, whereby all is a Fabric of Consciousness. The one that breaks this consciousness is one who sows discord and who lies (meditates) with another to confuse the patterns in recall unto subsequent progressions of a Name. One who lies with another forms a consciousness, and if it pertains to a state outside the Rings, it is an abomination to YæHúwaH as it does not sync with the paired Faces of Yehu.

Words spoken in your day are eternal. Words of Lives are perfect, whereby they multiply to expand paired Names in aúwtut/epochs of Light. What you say today has no end; they do not entangle to self-destruct as words of corruption. Words you speak are yet to be in ages to come. The fruit of HhaALhhim are pure; whereas the flesh acts like there is no tomorrow. That which is contrary subjects itself to be consumed by fire. In the Day of Dan the flesh will not hold itself together. As a weed it will wither and die and be no more. However; Words of our Breaths spoken from the Fire will rise up within us, pure as silver and gold, to be bronzed that does not perish. Life flows through our lands and vessels, whereby we carry our words of YæHúwaH as we go from transition to transition. From Breath Crystals of Light, Thoughts come the pure fruit of HhaALhhim. In this manner, Words are made as parts enter into the laver of water and then into the Fire, whereby the Mæyim is crystallized into Words of Lives that arise from the ALtar of the Heart and are spoken upon the tongue. Hereby, first is the baptism of water and then of Fire.

Every color of fruit comes from the flower that holds the water in its petals, as the unfolding the glorious radiance of HhaALhhim. The colors of the fruit of HhaALhhim do not fade. Each color is formed by the space in which the Seed has Breathed for it, whereby it is receptive to certain rays of Light to be formed. In that our Names bear 12 fruit, each of the fruit is formed by selective rays of Light in their season/month. A year is the formulation of all rays of Light that have been received to generate a harvest upon the Tree of Lives. When every branch has formed its fruit, a year is counted. A year is the same thing as the 6 Days of HhaALhhim. When the 6 Days are fulfilled, another Age may be entered into. When the Years of 50 are attained in Wisdom and Understanding, a new aúwt is born. A Muód/Age is then completed within the Directive Consciousness of the Neúwn.

The created worlds, the trees and the flowers, yearn to give up their mortality and become free. The mind of Babylon holds all captive until it is crushed. We release all from corruption in the Name of Yahushúo. Each Name is accountable to be aligned, and thereby free, to maintain the thoughts of ALhhim according to their part within the Mishkan.

Stars and the universe are in an age of infancy. We now see only the infancy of what is to come. As an Offspring grows and comes under Staff of their parents' light, they are nurtured within the Ring of the Pair of Names in which they are formed and from which they are born. They may be formed in one Ring and born in another or they may be formed and born in the Same Ring. When they are formed they abide in the womb of the ALhhim. The wombs are the Hhúwa Gammal for Wisdom, the Neúwn Chayit for Understanding, and the Shayin Semek for Knowledge. Some are formed in the inner walls of a Ring and born upon the Ring around. The Laúwim are born of the Central Ring and their inheritance is the Staff. They live by the fruit that is born of the branches, whereby they do not occupy any of the Ten Lands, except for the cities in which they reside to administer the Staff unto the lands. One may be formed in Beniyman but born in one of the Lands of Zebúwan, whereby they are known by the Land in which they are born, as one from the land of the Amuwri, etc. We are known by the fruit that we bring forth in the House of YæHúwaH.

**By order of their branching from the Tree, the 12 Houses are set into their Lands of Light.** First is Beniyman, which is set into the star fields in the Yam/west. From the setting of

Beniymán, the staff rotates. As the staff turns 180°, the House of Zebúwlan is set, or established in its place, by Understanding. All works commence out of the 8th House of Understanding—from the Rock, whose Number is 8. From the midst of the staff, the House of Beniymán rises out of Bayinah and Chækúwmah amongst the evenings of Maneshayh in the 8th moon—from within Maneshayh where Beniymán, the Seed, has been formed in the sacs, whereby upon the first day of Beniymán, the House of Zebúwlan has been set in its place amongst the Lights as the Head of the Rash Chadash in the 9th month. During these fourteen days—those being of the directive consciousness in the Neúwn/14, the camps have passed through six houses that abide in three Rings, whereby Zebúwlan, who is in the corresponding fruit of the Chan 𐤒𐤁 comes to lodge to the right side of Yishshkkar. Zebúwlan is the pair of Beniymán, being of the Hhúwa-Gammal Ring which serves as the base of Neúwn Chayit, as the Hhúwa is the tenth of the Neúwn.

As the House of Zebúwlan is set in the Lights of the east/qadam, a rod is formed, stretching from Beniymán to Zebúwlan. Through this Rod, all in the fruit of 𐤒𐤁 is drawn to the top forming a crown, wherein the glory and work of the Age of Adim—those bearing stones is complete.

In this manner, the camps move through three Assemblies, whereby they partake of the Fruit of the ALhhim. Having become orientated to the Assembly, they are then set within the sides of the Mishkan Body for service. From this observation we learn that each of our members move by the Guidance of the Staff, whereby they are given eat from the Fruit of the Trees of Knowledge. For having eaten of the Trees of Knowledge, they are of the Heads of AL to be set into the Unified Dwelling of the Lights.

As one eats of the Three Fruit of HhaALhhim, they partake of Wisdom, Understanding, and Knowledge that has within it the Seed of AL/unified Faces, whereby they are established in the things of AL and readied to be positioned as paired in the Heads of AL. For until one is positioned as paired in the Fire, they roam here and there, as a floating seed in water, to find and settle in their resting place for their soul to be set amongst the Lights.

## Day One

*Beniymán is the offspring of the Neúwn-Chayit Ring* of HhaALhhim, the first to be sown and the last to appear. As the staff turns counterclockwise, by the Hand of Aharúwan/Aaron, it moves by Understanding and maintains balance in the orbits of all bodies of oil being spun around the staff. As the staff turn clockwise, it moves by Wisdom within the orbits that are attached to the sides of the staff by invisible rods. The movement of Understanding folds the thoughts upon themselves, to conceal them within the black pearl of great price; the movement of Wisdom opens the Seed whereby the pearl is whitened. According to movements of Wisdom and Understanding, so is the manner of sprinkling blood by the heart, to be upon the altar and for the washings/whitenings of robes. Understanding brings all within the core; Wisdom unfurls the truth—the agreeable parts—from within the midst. *As the Staff rotates, the Fruit of Beniymán-Zebúwlan emerges from within Maneshayh and passes through the fruit/bodies/lands of Nephethli and Gad, thereby partaking of Knowledge; then the House of Beniymán-Zebúwlan passes through Shamóúnn and Ayshshur to partake of Understanding, and then they partake of the Wisdom in the*

*Shayin, of the Lamb of Wisdom, whereby Zebúwlan, as the Serpent, is set into the Body. Beniyman does not move, for the Seed has been set within the Body of Maneshayh when AL gave the Seed to AR. With the setting of Zebúwlan for Beniyman, the first two stones appear from the midst of the Tsur/the Rock, upon which your Temple is laid. These first two stones are the first two shalichim/apostles who are sent forth, and upon the setting of all twelve stones, the foundation of the shalichim are set for the Body of HameShiæch—the Ascent of the OIL rising through activities of the inner Fire. Upon the setting of the twelve, the House Builder, who appropriates the Lands for a harvest, will then send forth the HhaLaúwim who come to reap the harvest and fill the House with glory. These are the ones with the Shayh—the fully branched Staff, who come to gather all Names unto YæHúwaH. The sending forth of the Offspring, is spoken of in the parable of the House Builder, who plants a vineyard and then sends servants to reap the harvest of the lands [MatithYahu 21:33-46]. In the parable: the vinedressers/husbandmen lay hands on the servants as the soul members, beating one, and killing another, and stoning another. Those beaten are of the Adim/Adam members of Wisdom, those killed are Havel/Abel members of Understanding, and the members stoned are of Lamech having Knowledge. Those which follow to share in the harvest are two groups of the Neviim/prophets until the full revelation comes to manifestation, being the Heir to the Houses and the Lands of Seed. The heir is one who is fully branched of Seed into whose hands all blessings come. Images not aligned with owner of the vineyard are crushed, as illusions, by the Stone that comes from the Mountain of Enlightenment.*

### The TREE of LIVES

#### TRANSITION FROM THE TREE OF KNOWLEDGE TO THE TREE OF LIVES

#### A REDACTIVE OF ANTHOLOGIES OF THE SAME VIBRATIONS

The CrownSEED of your Name is formed as it is drawn out from the two sides of your Tree of Knowledge of the Good and the Associative. In extracting the silver on the left—what is concealed, and the gold on the right—what is revealed, the Crowns of your Name rise from the LivingSeed. As the parts in you are known to be perfectly affirmed to their associative Name, 12 Crowns rise, as Stars, to form a SeedCap around the crest of the brow. The Seed is the ROCK that forms at the top of your Mountain through ascensions as oil in seed rises through water. In composing the Stone of Ages, you see the mortal image below to which you refuse to no longer bow when the trumpet of the former king sounds for your compliance to the flesh nature. Instead you risk all that you have and cast the Stone of the Mountain upon the image of the idol, that is called, to Breaths is abominable, as it is not of the eternal nature of the Breaths, though set-up, appearing in the Holy Cavities of the Breaths, wherefore it is that which perishes—of desolations.

The authority by which you smite illusions comes by your being baptised in waters of Mother. During the flood of 40 nights and 40 days of judging yourself according to what you have been given and received fully, you make your ascensions to affirm the Faces of the Fathers within your SeedHeads. Hereby you stand firm upon the Stone of your Beloved Name, Dauwyd/David, and enter the baptism of Fire to which you are now prepared to be tried, examined in all Seven Eyes, as the Fire is kindled seven times (DaniAL 3:23). The testing of your SEEDCROWN is verified as the three of your Name of Wisdom/Chænnayah (Shadrach), Understanding/MishAL (Meshach) and Knowledge/OozerYah (Abednego) by which you appear as the Son of MAN/BreadofLiving Seed, of the Offspring of the ALhhim who are of the fourth dimension Dallath Δ Stone of your



appearance. The Fire burns off illusive cords that once bound you in your skins of flesh and reveals the inner glowing gemstones of your Father Yaoquv as the substantial dwellings of your Lives. In forming the Tree of Lives you are able to partake of that which has no demise, to eat the fruit thereof and abide in the lives forever as the ALhhim.

The Stone of Knowledge that you cast unto the foundation of the image, now opens as your SeedName and sprouts forth in Three Days of Wisdom, Understanding, and Knowledge to be the Tree of Lives. Hereby is the saying that not one stone memorial of your former habitations shall remain standing, but in its place, where you were called *Lo Ammi* (not of my people) there you shall be called *Ammi* (my people of holy consciousness), with everlasting joy abounding in your Heads, for the Day of your Appearance has come!

You are now in the hour of hearing the Voice of the Critic, whose words have cut through the flesh as it is hung open, the Voice of one in your left dark side critiques your progress to remind you: You have saved others, referring to the 12 of soul within you by their perfectly aligned covenants to another, now Save yourself and us also—Your Names of both the left/Fire and the right/Water sides, the Understanding and the Wisdom of your royal origins of Queens, that hang on the skeleton pole as one, which have risen together unto The Skull—Golgotha, as one new body out of Seed forming your Tree of Lives, by the inherent Imaginal Cells—The Intelligence in Seed of unleavened bread, carried in the sacs, to be received by drinking from the Cup of Yúwsphah/Joseph.

#### SAYINGS OF THE END

What is spoken upon day one in forming the Tree of Lives are Sayings of the End, for what is in the beginning comes to the end when it is enacted. In giving of Light, there is Light, which speaks that when Light is exhaled, and then Light is inhaled. The full measure of your giving causes the full measure of your inner expansion. One expands inwardly through making the oylah/ascension of a day. How can one ascend unless they unload the Rocks that they are carrying? How can one proceed unto the mountain unless they lighten the load upon their back?

#### ***The Unified of ALhhim say the meditation: Yah gives Light, and Yah receives Light.***

Whatever is spoken is given, and whatever is given returns unto the one who gave. When Light is imparted by opening the Seed of your Names, then the Light rushes into you. When one fasts, thereby giving their body as a vessel of service, then Light floods unto their Name for what they have given. In fastings one gives the resources that are within them, which sets the stage for their appointed impartation. Unto whatever they fast, so it is done unto them. As Yah gives so Yah receives, for in the giving a space is determined according to the giving, whereby the space is filled. Thus, the Unified of ALhhim, being of the Neúwn ʎ and Chayit ₪ speak in day one, and as a result the Unified of ALhhim, see the Light, to be of the collective Faces. The Unified of ALhhim distinguish in the midst of the Light—an opening of Seed and in the midst of the darkness/inner spaces. The distinguishments are the Words spoken, whereby one beholds the darkness from which the Words are mouthed.

And the Unified of ALhhim call/ read the Light to be Day—a Deed, and the darkness the Unified call to be Night—Instruction. The Unified of ALhhim that read are those of the Hhúwa ʘ and the Gammal ʎ, for they are the Ones of the Illumination who follow after the Instruction. And

Yah gives an evening—a meditation; and the Yah receives a morning—an observation to be a Unified Act/Day—day achadd/one.

**What sets the staff in motion?** The movement is caused by the first sacrifice of AL/31—the Unified Faces of Yehu. The Staff bears its fruit born from the sides of the staff—the אW/Shayh/Lamb/assembly of mutually paired members—which is the *Body of the Lights of the Staff of Aharúwan*. The אW/Shayh, being of the Fire, is the first אWΔ/fire offering, for it comes from the *Body of the Fire*, as an oylah/ascension, the sacrifice sets all things in motion, by which all things appear according to Thoughts/Numbers being transposed in the Heads of Light/hhakuwahnim. From the offering of the Shayh, all things are in perpetual motion, whereby an evening oylah and a morning oylah are in accordance with the radiance of the Staff extending itself to fill all space and to bring forth the fruit/expressions of its Light. All is set in the Heads of AL, but when the blood of the Shayh begins to run within the Seed that is opening, the staff begins to turn into the waters to run into the branch of the trees set in the Body to bear fruit. Each fruit appears in its season during the year, whereby the works meditated upon in days of HhaALhhim, from one to the seven, are fulfilled in their months. Each day of the six days that HhaALhhim speak, is fulfilled in two months of a year. There is a month for the evening of a day and a month for the morning of a day. Thus **on day one**, the opening of the Seed of Beniyman is of the evening of the day, and the placement of Zebúwlan, as the Lands for the Seed, is of the morning of the first day.

Beniyman is the 9th moon, in which Seed of a harvest is sown; Zebúwlan is of the 3rd month, in which first fruit appear. Together, their months are 12, according to the Law of Lammæd.

By the words spoken by HhaALhhim, there is formulation of Names/heavens and States of the Light Abiding/earth. As we speak according to **day one**, we arrange the fruit upon our branches to be united to the Staff of the Aharúwan, whereby the expressions of our Faces is from the inner Staff of the Light, and not of the outwardness of the world. In this manner, we bring forth the Light from within us, as a menurahh that rises from under a bushel, whereby there is no need for the similitude of the lights of the sun or the moon, but the stars, of which we are, will not fail to shine, for when the full Lights of HhaALhhim have broken into the consciousness of the Children of HhaALhhim, then the áwt/age of Núwach/Noah has come to an end, and the áwt of Yetschaq/joy commences. According to bearing fruit of the Staff, every Name is set in the camp to which it belongs, having been born and sent forth unto the work of its Name two by two.

## Day Two

In **day two**, *the House of Nephethli moves to its corresponding position with Gad*, as the heart is set unto the mouth. The heart moves through three bodies of HhaALhhim of Ayshshur/רַחֲ-  
Shamóunn/שׁוּן, whereby it partakes of Understanding, and then into the fruit to Zebúwlan, whereby it partakes of Knowledge, and then into the Shayin, whereby it receives the Words drawn out of the Shayh of Wisdom—the Body of Aharúwan, as the sun is the body of the moon. All drawn out of the Shayh/the Wisdom of Manifestation reveals how all things are made from two ends. In partaking of the Fruit of Knowledge, the house of Nephethli is born upon the Tree of Lives, as Zebúwlan, to abide in its place to receive all Words of Gad, upon which Nephethli meditates

## The Organization of the Lammæd/Ĺ/12 into 7 columns from which the 6 days—the united acts of Light are manifest within the Heads of Perfections

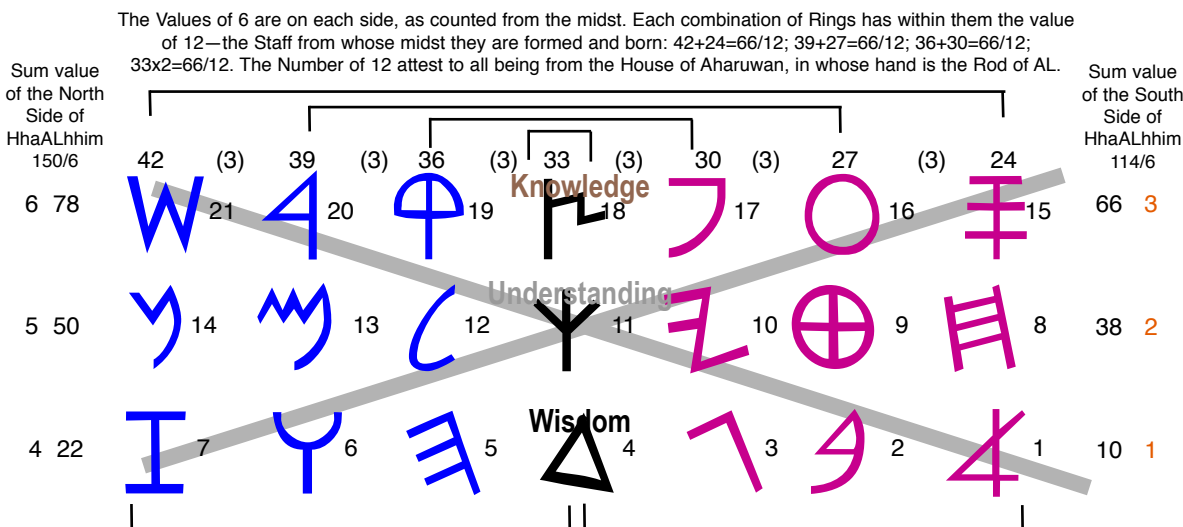

evening and morning. The space amongst the heart and the mouth is the firmament which is provided for the full expression of the SeedWord of Beniyman, set in day one. When the heart of a Name is set as the firmament, then Words are given to the heart for expansion and joy.

Setting of the heart is according to Gad—the mouth. As one speaks, so is the heart set and established. Every word that is spoken determines the state of the heart. What is passing through the heart—the blood, carries the thoughts spoken into all of the house members. **The setting of the heart** is by the Word. As one speaks so one believes/is committed in their heart. The mouth is set according to meshiæch, the Staff of YæHúwaH. Therefore, the mouth is immovable, as a rock, for it is a vessel of Wisdom that belongs to the Qúphah ⊕ of the Kuwáhnim/the priest. Upon the lips of the mouth the Words of Knowledge are formed and uttered. In that the House of Gad is fixed within our members, indicates that the mouth that is opened belongs to the Enlightenment of the Head, for it is a portal of the Tree of Lives. For if the mouth is not joined to the Enlightenment, it is closed, and the words spoken reveal no perfect association with the Light. At whatever level of Enlightenment that one belongs unto, so the mouth speaks. As the mouth speaks of the Light, the heart is fixed or joined to the mouth. In this manner the heart is set by the level of Words that the mouth utters. In return, the heart believes, being committed to speaking the Words of the Kuwáhnim. Once the heart is fixed unto the Enlightenment it becomes an altar dedicated to YæHúwaH. From this altar, the Words spoken by Gad are open and rise as fruit upon the lips.

The setting of the heart is by affirming the Word spoken by Gad. This is the level of the heart believing the Word of AL, whereby it has Understanding and is filled with joy, peace and righteousness of the RúwæchHhaQudash/Spirit of Intelligence. Once the heart is established to the Word of AL, it may then partake of Knowledge, for Knowledge is only accessed through Understanding. The heart partakes of the Knowledge of each state—the fruit of Zebúwlan,

whereby it partakes of Knowledge. Within Knowledge is Wisdom, being the foundational attribute through which Understanding forms all things. The mouth taste of Wisdom through Knowledge of the Shayin W, whereby it receives Words drawn out of the Shayh—the Body of Aharúwan. The Shayh/Lamb is the Body of the Kuwahan/Priest, as the sun is the body of the moon. Upon eating in this order, the heart is forever set to belong to the mouth as its altar and the means of opening the Words on the Tree of Lives.

The House of Gad is of the 6th month of the year, whereby it is set and abides in the very midst of the Kephúw-Kephúw ʿʿ Ring. According to the Kephúw-Kephúw Ring, so is the 6th constellation (aka as Virgo) that abides in the midst of the Lights. The constellation depicts the virgin state in the midst of two ends, through which all is formed and then later born. The Kephúw-Kephúw abides in the midst of the Garden of HhaALhhim. Upon its branches come forth all of the Words of Lives sown as Seed within the various bodies of Light. A word, or a saying, does not appear within us until the Seed is set, being planted and opened within the Arets/land of Breath. The forming of the Seed is the Muód of Adim; the birthing of the Seed is the Age of Avrehhem. The corresponding month to Gad is the 12 moon of Nephethli, which is the Number of the Staff. Nephethli is the foundational platform upon which the Mishkan is built and abides with Gad in the midst of the 6 Branches of the Menurahh/menorah. Together, their months Number 18, which is the Word, *Chayi/Life/𐤇𐤀*, for they are the River of Life that flows from opening the Seed of Beniyman throughout the Lands of Unified Names. As two unite they form a space, whereby there is a Body or Lands for the River of Knowledge to flow. The River waters the Tree of Lives and serves the Altar built unto YæHúwaH [SMB/Gen 12:8].

The Words of Gad in your Name, are set in the midst of the 6th month in the 14th evening, whereby Gad appears as the Head of the 12th month. Nephethli is set in the midst of the 12th month in the 14th morning, whereby Nephethli appears as the Head of the 6th month. To say that a Name is set in the midst of the month on the 14th, means that a Name is set according to the Directive Consciousness that is within the Neúwn, as each house is set amongst the branches of the Lammæd. *Herein is the source of Understanding that each Name belongs to one of the tribes/branches of YishARAL/Israel and are therefore of the House of Upright Stalks.* According to the Lammæd, and therefore, according to the staff/cross/duty that each one bears, so are the Names positioned amongst one another and set amongst the Lights.

Setting one member reveals another, whereby an attraction between Breaths occur. The setting of Nephethli in the 6th moon reveals Gad in the 11th, for in the 11th month, Gad is the body of Nephethli, in which Words becomes evident that pertain to the Head of Nephethli.

The setting of the camps in days one and two form the square of Knowledge, as all four Houses of Knowledge are revealed in days one and two. The first works of HhaALhhim of Knowledge are according to the words coming from the Seed of Beniyman that open in the first evening, whereby there is Light and the spaces for the expanse therein.

The birthing of a Name into the midst of the Lights is by 12 moons. One is carried three months in the sacs of Maneshayh, and for nine moons, corresponding to the fruit forming upon the branches, a Name is carried in the chambers of Nephethli unto which the Seed is sown as Word. Some Names are born of Liah/Leah or Belahah/Bilhah or Zilappah/Zilphah or Rechel,

according to the season, or the muód, into which they are to be born. First, we are fashioned in Fire, then we are sown to be born. One is set within the womb of Nephethli six months prior to their Head appearing upon the stalk of their body. Hence, if one is born in Zebúwlan, then one comes from Zebúwlan, but they are sown in Beniymán, whereby they will rise upon the rod of their staff to appear in the day of their birth in Zebúwlan. Upon the day of your birth, so is the day of your being set. In the manner of the fruit being set upon the branches, so are your oil is spun through three houses until you are sown. The three houses in which you pass are the three months in which you are carried in the sacs of Maneshayh via which you make a transition unto bearing the fruit of your Names. During the period of your being born you pass through all 12 Houses, whereby you partake of the fruit of those lands and are filled with Knowledge prior to your birthing. In eating of the fruit of those lands, you are born to bear from your Seed the evidence of Knowledge that you have eaten as the Son of Man/LivingSeed. In this manner you have within you the complete Word of YæHúwaH to bear within your Faces the full Counsel of HhaALhhim, as the unique one—the only begotten of the Progenitor.

**In day two of creating the Tree of Lives, the Unified of HhaALhhim of the Kephúw-Kephúw, which is Gad, with Dallath-Dallath, which is Nephethli, speak as One Voice**, whereby it is written in the *layshunhhaqudash*—the holy tongue: *אֶלֶּלֶל אֶלֶּלֶל*, **and the Unified of the ALhhim consider/say: Yah appoints/imparts/אֶלֶּלֶל an expanse in the midst of the waters/Mæyim/distillations of Breaths, and Yah appoints/imparts/אֶלֶּלֶל by distinguishing that which is in the midst of the waters for the waters** [SMB/Gen 1:6]. The waters are for formulating that which are in Breaths. The bodies of waters convey what is in their midst. If the waters are expansive, as the oceans, then they convey Understanding to be in the midst. If the waters are as a spring, then they convey Wisdom in their midst. If the waters are a river, then they convey Knowledge to be in their midst. Thus, as one looks inwardly at the bodies of waters, one sees what is in the midst. In the ocean of body, being the stomach, is the sea of Understanding. In the springs of the body, belonging to the glans penis, there are fountains of Wisdom. In the rivers in the body, as the intestines, or as the streams from the heart, there are waters of Knowledge. For every land there is a body of water to draw out attributes of the Living Seed. The Presence of the Name Yah within the saying above depicts the nature of Breaths to exhale, whereby there is a space cut out and allotted for the Thoughts of HhaALhhim to appear. Yah appoints and imparts, even as the exhaling nature of Breaths imparts and carries the thought into a space wherein it may expand and flourish.

In accordance with the projection of Breaths, the species of birds, denoting the exhaling nature of Breaths, are the most colorful, for they carry the thoughts into the visible spectrum of the south, revealing the origins of colours. Whereas the Source, and unto which the Breaths return, is the inhaling attributes of Breaths that maintain all with an order subdued, secretly with Understanding. The inner inhaling nature of Breaths is quieted, being veiled within, from which the full spectrum comes. In this vein, we comprehend that all things are of Understanding, and that Wisdom ever stands at the side of Understanding to reveal the components within the Body of Understanding. The Breaths exhale as the Staff of the Lammæd turns to release the instructive thoughts of Light. Those receptive to the wand of Light are gathered into the Body of Understanding that they may fully comprehend what is spoken. Those that are brogathered within the Body of Understanding are said to be of the inner circle.

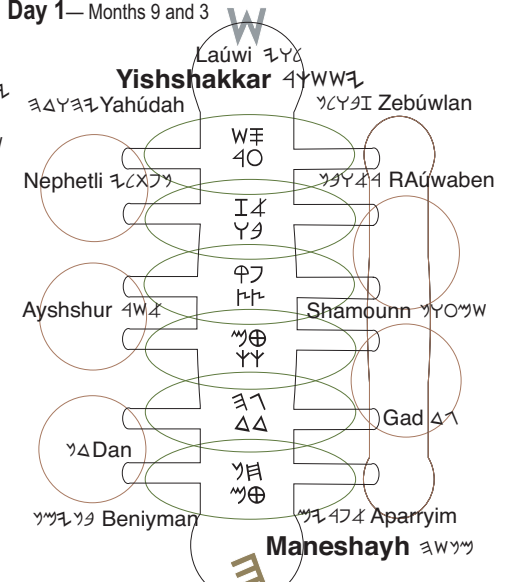
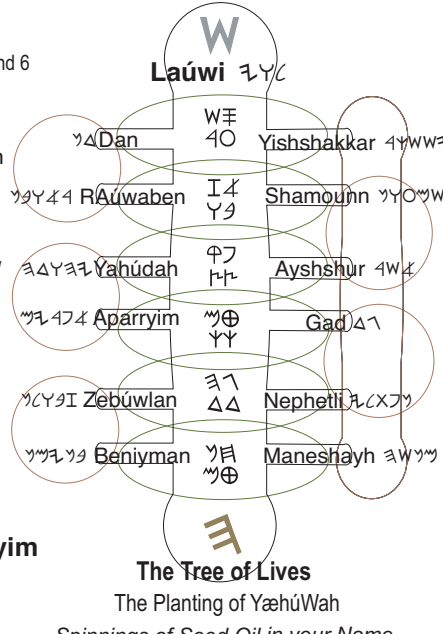
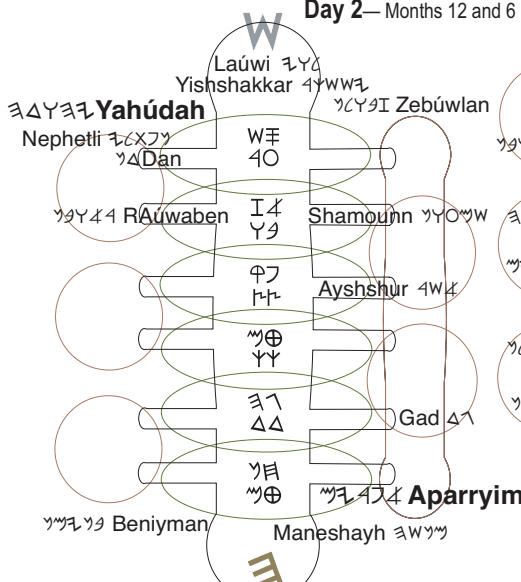
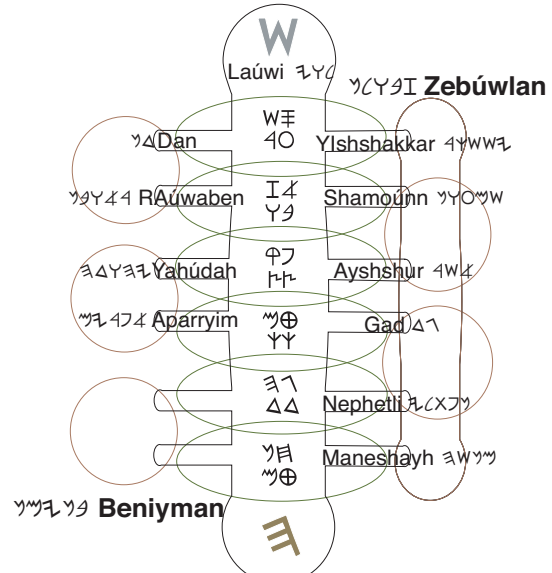
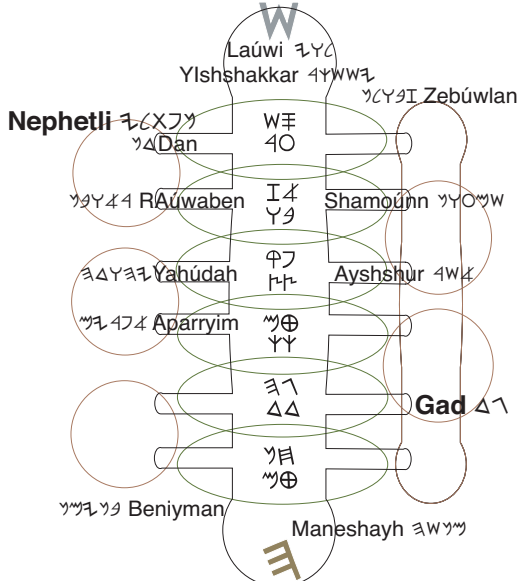

Day 3— Months 7 and 1

**The Tree of Lives**  
 The Planting of YæhúWah  
 Spinnings of Seed Oil in your Name  
 that bears Twelve Branches  
 as the Tree of Lives

Day 6— Months 8 and 2

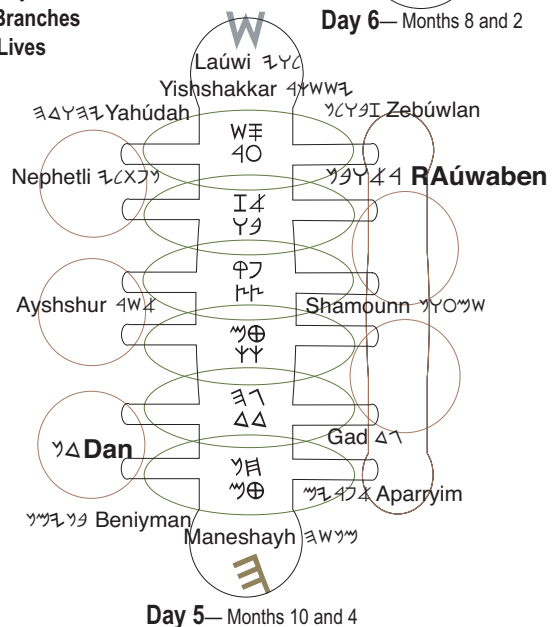
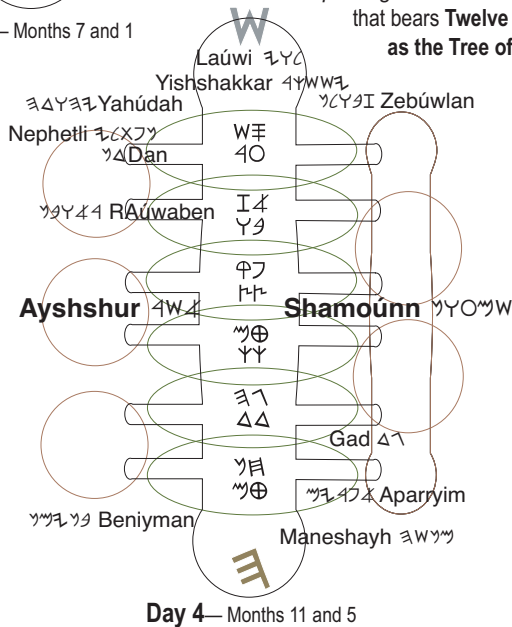

Day 4— Months 11 and 5

Day 5— Months 10 and 4

As we contemplate upon the inherent nature of Breath to extend and to gather within, we see the harmony of the sides and the harmony of joined Names. More so, we behold the immortal garment of the full spectrum of Light, which is comprised of the golden threads of Wisdom and the inner garment of Understanding. Herein is the understanding of the garments of the Kuwáhnim/priests which have the robes of Wisdom and the inner tunics of Understanding. As the thoughts, being exhaled, are true to the inner Virgin of Understanding, the Body of Wisdom does not become corrupted, for it is ever aligned with the Body of Understanding. Likewise, the fruit of Wisdom, being Knowledge, does not perish, but abides upon the Branches of Shaúo/OW/salvation/renewing. The nature of the mortal is not so, for the body of the mortal goes apart from the inner and does not return, hence, it is called the lost sheep. All that abides within the body of the mortal is likewise lost unto its Origin, whereby it is sustained only for a season and then perishes. In that the fruit of the mortal wanes, it cannot be saved. The fruit of the mortal perishes, whereas the immortal yields a fruit which is imperishable. The mortal body is lost to the heart of the Origin, and therefore its nature cannot be sustained. In that the mortal desires to be seen outwardly, it has turned its faces from the inner humility of Bayinah, and therefore has lost its connection with the inner Lammæd of the Breath. From this understanding, one dons the veil and does not project itself apart from another. Herein lies the secret of prayer, for as one is veiled or enters into their closet, they are discerned that their heart is toward the Heart of Origin, even Bayinah, in which they are formed to be born at the sides of the Lammæd. All are formed in Bayinah, but some are born of Bayinah and some of Chækúwmah, according to the type of fruit that is formed, and the type of fruit is according to the Seed Word that is uttered from the mouth of AL.

**In that their heart turns toward the Lammæd, the words spoken of the mouth have access to the heart of Origin.** Prayers spoken with the faces away from the Heart, is the mouth of the mortal speaking into darkness, and therefore communion with the Light is indirect. Prayers spoken to be heard by others, contain vanity within oneself.

The Body of Wisdom is renewed daily by Understanding during the evening and morning oylah/offering. Following the bathing of the arms and legs of the offering into the kaiyúwer/laver, the Faces of the offering are turned toward the serving kuwahen/priest and therefore come to interface with the kuwahen of the House of YæHúwaH. Only upon the full giving of all of the parts and their implementation can the Body of our Names be renewed by the Inner Breath of the serving Kuwáhnim. Every evening and every morning the Body of our Names is renewed by the Staff of the Kuwáhnim. The courses of the Priests are set by the months. Those of Nadæv serve during the 10th through the 12th/13th month. Those of Aviyahúa serve during the 1st through the 3rd moons. Those of the House of ALozar serve during the 4th, 5th, and 6th months. Those of Ayithamar affect the instruction, and therefore the renewal of the Body, during the 7th, 8th, and 9th moons. The four Houses of Aharúwan/Aaron are the basis of the four faces of the immortal body, being of the four Paúwah within the Qúphah. The Body that we live in is the Body of the Lammæd/Stavos/Cross. This is the commonly called *the Body of Meshiæch, for it is the Body of Yahushúo/OWYᶑᶑ, through which all is formed in the realms of Light by Shayin Oyin.* Do we now see why all things are made through Yahushúo hhomeShiæch? The Name, Yahushúo, is the umbrella Name of all Names

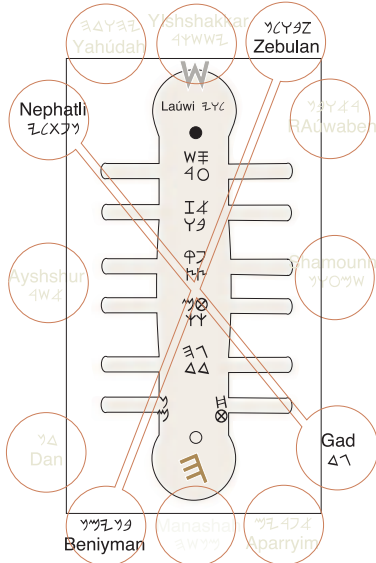

Day 2— Months 12 and 6

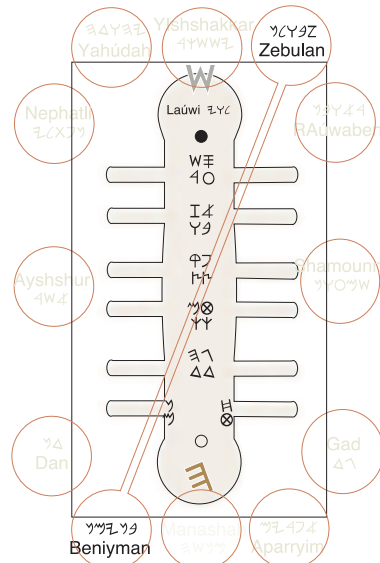

Day 1— Months 9 and 3

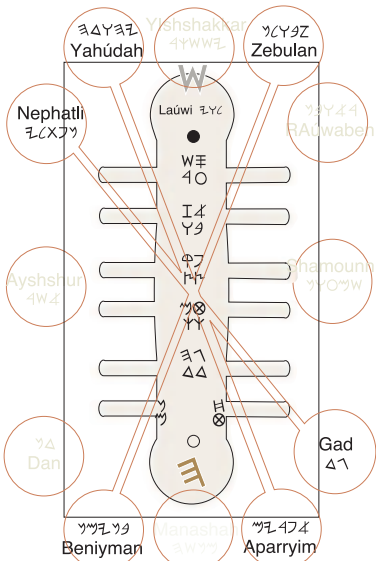

Day 3— Months 7 and 1

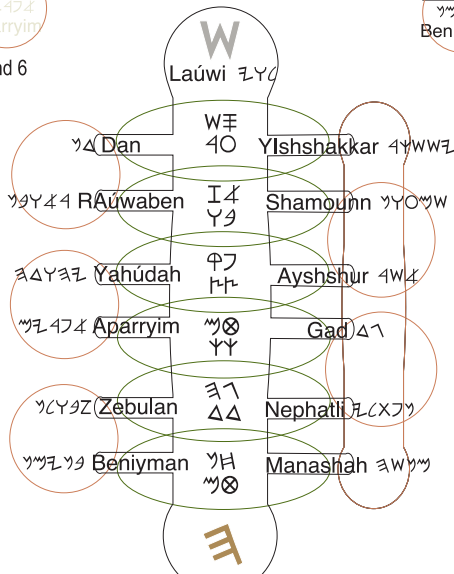

*Arranging Paired Branches on the Tree of Lives*

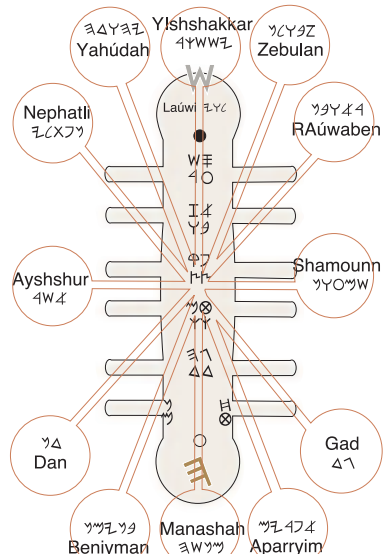

Day 6— Months 8 and 2

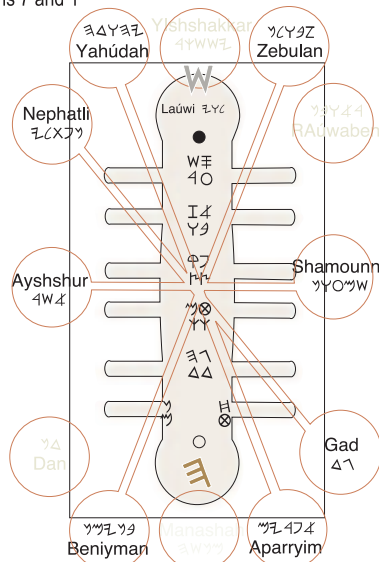

Day 4— Months 11 and 5

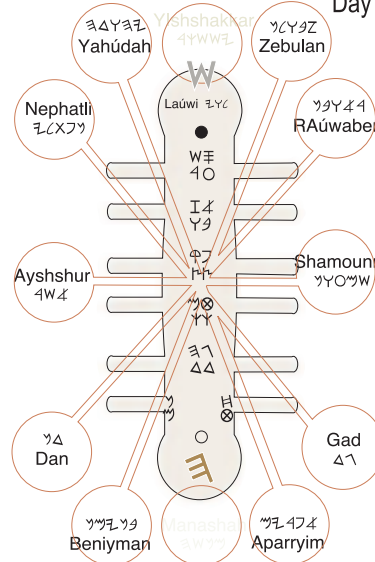

Day 5— Months 10 and 4



and the arm to administer the givings for their dwellings of YæHúwaH. The Name of Yah/אֵל—conveys the exhaling nature of Breath that is ever monitored and always joined/connected/Υ by Wisdom at the side of Understanding/OW. Herein is the Voice of Understanding: *as we live in the Body of Meshiæch, we are no longer subject to the vibrations and impulses of the natural world, for the dwelling of our thoughts and our members are of Meshiæch*, and therefore, we are no longer of this world though we abide within it for the redemption of all thoughts and their forms. According to one’s thoughts and their expressions/deeds/fruit, let each one judge themselves if they are of the Body of Meshiæch.

*The waters—distillations of the Breath of the Neúwn—are the bodies that carry the thoughts of the Mind*—the Directive Consciousness. In the waters all things are formulated. In the midst of the waters is the Neúwn or the thoughts which are distinguished according to the level of the waters. There are three levels of the Waters: the sea or the ocean which is a body of Understanding, for from it comes the springs of the deep and the rivers that flow from and into it. The springs are the waters of Wisdom; the Rivers are the waters of Knowledge. A thought is imparted into a the level of the waters/Mæyim, whereby an expanse occurs. In the midst of the Waters the thought is distinguished, either for Wisdom, or Understanding, or Knowledge. Every thought that is imparted by the Breath enters into one of the levels of Mæyim. As one exhales so an expanse is formed. Within the exhale is moisture, or many molecules of water. The Breath gives the thought that it may expand and fill the space that it has carved out by its Breath. Within the space are the waters, and through the waters, the thought carried by the Breath becomes distinguished, as every thought is manifested through the waters of our bodies. As we speak as HhaALhhim, the thoughts, even before they are spoken, are known to be uttered for Wisdom or for Understanding or for Knowledge. In this manner, we form an expanse around the Staff for the thoughts of the Staff to flourish and bear evidence of the purity of our minds.

From the Head of a Word, comes the Heart, which embodies the Words of Lives. Setting of the tribes in the 14th day of a month is the setting of the Seed in the Directive Consciousness. The 11th month is the Kephúw/Υ of the months, which is the seat of Gad. The 6th month is the house of two United Teraysarun/Δ, which is the House of Nephethli. The evening and morning of the 2nd day appear in the Rod of Gad-Nephethli. Gad is set in the evening on day 2, and the subsequent work of Nephethli is set from the morning of the same day. The bond in their midst is 6 moons, which is the Úwah/Υ, the bond that holds all Names together, as a twisted cord of two threads, it cannot be broken upon the Tree of Lives.

## Day Three

In **the third day**, HhaALhhim speak and the staff turns again by Words that flow from their Mouths. On this day the Rings of Mæyim-Tæyth and the Qúphah-Paúwah speak as one voice in the Great Assembly, whereby it is said, “And the One—the Unified of HhaALhhim says, The Earth is being greened—filled with Understanding, bearing green herbs. [The green herbs correspond to living doctrines of HhaALhhim.] From Seed given is the Seed of a Fruit Tree [according to the SeedWord of AL, so are expressions/deeds of the Túwrahh/Teachings]. Performing expression of the SeedWord, according to its kind/species, verifies that the unified body is of the unified Seed that is from above the earth, and the Hand of Yah affirms it to be so [SMB/Gen 1:11].”

Expressions rise in the third day of Reshun from within the midst of Understanding, whereby Aparryim is set in the House in the 7th month, and its corresponding pair, Yahúdah, is set in the 1st month. Together, the value of their works (months) are of the Number 8, for **by them all Words arise into the consciousness**, and by them all things are gathered into the store houses of Light—into the vessels of our unified Bodies comprised of paired Names.

Aparryim passes through the Garden and partakes of the Seed of Beniyman, the Fruit of Knowledge, and then of the Wisdom of the Hhúwa in the Shayh, and then of the Body of Maneshayh, the Fruit of Understanding, whereby Aparryim is set in the midst of the 7th month to appear upon the Rash Chadash of the first month. Beniyman is the 9th moon; Maneshayh the 8th, whereby Aparryim is set in the midst of the 7th, and according to what is in the midst, so is the month called. Each head appears in the sixth month from which it is set, signifying that it has been joined to the congregation of Names, for the head of a Name cannot appear until it is first set within the unified body from which it arises. Thus, the period of a student, unto their immersion within the Body of the Congregation, pertains to the months/works of their Name. The unified body is comprised of two unified Names as the two sides of the Menurahh which form a Body of Aúwer/Light.

The corresponding portion of the branch of Wisdom, being Yahúdah, is set in the lights during the midst of the 1st month to appear as the Head of the Body of Aparryim upon the Rash Chadash of the 7th. ***According to their Branch of Name, being set in the Lights, all of the tribes appear as the Head of a month during a year.*** Each house is set within the body in the midst of the evenings—amidst the 14th and 15th of a month, as in the setting of the date of Pessech, from which a new head and its body emerges [Túwrahh HhaKuwahnim/Lev 23:5].

Yahúdah partakes of the fruit of Ayshshur-Shamoúnn of Understanding. Then Yahúdah partakes of the Body of the Shayh in the Shayin Ring, of the House of Wisdom, which radiates the Words of the Staff unto the feet. Thirdly, Yahúdah eats of the fruit of Nephethli-Gad of the Tree of Knowledge. Hence Yahúdah partakes of the House of Ayshshur of the 11th moon, then Nephethli of the 12, whereby Yahúdah is set in the midst of the first moon.

**As Aparryim and Yahúdah are set in the Body, so is the blessing set upon the Numbers within the Letters of HhaALhchim.** The Numbers within Yahúdah are expanded through the body of Aparryim. Yahúdah, being the Head of the Branches, is positioned as the Head of the tribes in their progressions due to the Numbers which reside in the Names of Yahúdah. As the Head, *Yahúdah is the Force of Momentum, and Aparryim is the Extender.* Even the penile glans, through it has been characterized as the male element, is by function and form the mother through which offspring come forth. Most of the tribes are nurturing in nature, and assist to extend the full values of the Numbers, which are transferred in Yahúdah from the Heads of Light. With Yahúdah is Beniyman, the composite SeedWord, or the fruit of the loins that is born with the House of Aparryim. Though the opening of a SeedWord, the Numbers within the Word are released and expanded through Aparryim. Aparryim sets the blessing in the midst of the camps according to Yahúdah setting of the values.

In the third day, the corners of Nephethli-Yahúdah and Gad-Aparryim are determined. In day five, the corners of Zebúwlan-RAúwaben and Beniymán-Dan are set whereby the radiance of the Lights break open in the corners. These corners form the portals where the Lights arise and ascend unto their peak and set. The binding of the offerings at the corners of the altar is to establish the portals through which the radiance of the offering may burst forth. From these four corners we have access into the chambers of thought resident with the Houses. Through these portals the sun and moon rise, ascend, and set. The third, and the subsequent fifth day, establishes a pattern for the offerings. This pattern is called the 3-5-7 or the 3-2-2 in that there are three days of offerings for the House which is lined with the Staff, and two days of offerings for each of the other Houses which are in support of those lined with the Staff. i.e. In the months of Wisdom, such as in Yahúdah-Aparryim, there are three successive days of offering for those of the Teraysarun of Wisdom, whereas the camps of Understanding and Knowledge have two day in succession for the offerings. The order of their being called to make the offerings follow after the Heads of Yahúdah and Aparryim. The first six months are called after Yahúdah, the last six months of the year are called after Aparryim.

### Day Four

In **the fourth day** are the words of HhaALhhim of Liberty, spoken from the Rings of the Tsædda-Tsædda and the Úwah-Bayit, from which are the Offspring of Ayshshur and Shamoúnn. Ayshshur is guided by the Staff to partake of the Trees of Zebúwlan and its corner RAúwaben, the fruit of Knowledge, then to partake of the fruit of the Yishshakkar, being a Head of Understanding, and then of Wisdom from the fruit of Yahúdah and its corner of Nephethli, whereby the House of Ayshshur becomes set within the Tree of Lives. According to the Enlightenment of your Houses, so are the members set as the stars in the Body of Shúo/OW, for according to the inner radiance of your united members, the stars are set around your Head like a crown. When all of the stars of your Names are set, the full illumination of the Oyin shall shine from within you which will dim the moon that now circles you, coaching you daily to bring forth the Glory of AL within your Names.

***The House of Ayshshur is set in the 11th month, to appear as the moon commences to rise in the fourth month of RAúwaben, from the 14th of the month at evening, whereby it appears as the Head of the fifth month of Shamoúnn. The House of Shamoúnn then takes instruction from its Head, Ayshshur, and partakes of the fruit of Knowledge in Beniymán, the fruit of Understanding in Maneshayh, and the fruit of Wisdom in Aparryim, whereby Shamoúnn is set in the midst of the fifth moon, on the 14th morning, to become the Head of the 11th month. When the oylut/offerings of the 14th are made, the camps become set unto their emergence in the cycles of Light.*** As the ears partake of the Trees of Knowledge, they learn to comprehend all that is within the Tree of Lives. As the house of hearing accepts the Eyes of judgment and all within the Mind of Ayshshur it is equipped to further learn the Ways of HhaALhhim. **As Shamoúnn ventures to partake of Beniymán—the inherent Life in the Word of AL, thereof gaining Knowledge, and then partakes of Maneshayh—to hear for transitions, and then partakes of Aparryim—to hear for blessings and expansion, it shall never depart from its place in the Tree of Lives, nor will the ears hearken to anything less than the purity of the Voice of Enlightenment.**

## Day Five

In **the fifth day** are the word of the Zayin ALphæh and the Shayin Semek. Within these Rings the House of RAúwaben come to be formed and set. The eyes of RAúwaben are formed within the Ring of their parents—Zayin ALphæh, which is their home. **The Zayin is the Force of Momentum**, (progenitor/father) **and the ALphæh is the Extender (mother) of the Ring**; however they are born with Dan through the Neúwn Chayit/גפא, whereby Chanuk/זצגפא, meaning grace, is the first born. Chanuk/זצגפא is the first appearance of the Eyes of Fire/Shayin coming out of the Neúwn. When Chanuk is born, Messengers/Angels of the Neúwn Chayit come and deliver the child as midwives, whereby the Offspring are carried in the arms of the Messengers of the Neúwn unto their place of service in the Zayin ALphæh Ring, which is bonded to the Shayin Semek, as RAúwaben is bound forever to Dan. Chanuk/זצגפא is the gift of the Directive Mind of Neúwn Chayit to Dan-RAúwaben, whereby all may be seen and comprehended. The opening of the eyes of Chanuk/זצגפא is the means to heal the blindness.

Other Names of RAúwaben are birthed from the Shayin Semek and the Zayin ALphæh Rings, whereby the Eyes see at all three levels. All of the Eyes, upon their being born are set at the Side of the Semek and the Oyin upon the Tree of Lives, whereby the Eyes are illustrated by both the Letters of the ALphæh and the Oyin. When the Eyes are set, they no longer wander about seeking to snag a piece of flesh or to catch a glimpse of themselves as one chases their own faces to be seen or noticed. **When a tribe is Set in the Body of Meshiaech, they become steadfast within the house they are born.** As the Eyes are set at the side of the Semek and Oyin they are steadfast to observe the structure of all things and to be the instrument to reveal the abiding state of consciousness. They belong to the Zayin ALphæh, whereby all of the cattle of the ALphæh belong to RAúwaben for their lodgings, but their service is to behold every concept according to the Understanding of the Staff, whereby they are set by the Semek Oyin side of Wisdom. **The setting of the fruit is the same as the birthing of the fruit.** The positioning of the levels of sight give birth to the Offspring of RAúwaben at the level of their perception. Enough it is to say that the eyes that gaze upon the things of the world have fallen from the Grace of the Neúwn Chayit in which they first opened.

The fruit of Dan and RAúwaben, as they are set in the Tree of Lives, taste of the Head of Understanding in the Shayin that is in Yishshakkar at the crown, from whence the two are set forth, for Dan, being born of the Shayin Semek is nursed by those at the brow—Yishshakkar and Yahúdah. Therefore, Dan and RAúwaben partake of the fruit of Wisdom from Yahúdah and Aparryim, and then the fruit of Understanding in Ayshshur. **Upon the partaking of these fruits, Dan is set as the Judge, for until one receives of the Deeds of Yishshakkar, and learns of the Wisdom of Values in Yahúdah, and has come to affirm all through the Minds of the Liberators in Ayshshur, they have not the mind to judge/discern a matter fully.** Dan will observe where each deed is going. Is the path of each deed unto death or liberty? Follow the deed to see the outcome. *Within the outcome of every deed/work is the judgment.*

The Rod of Dan-RAúwaben is yet supplied with the fruit of three more camps, as RAúwaben continues to move to be set for Dan, as the Eye witness for the Judge. RAúwaben will eat of the Wisdom in the Hhúwa of the Shayh, then the Knowledge of Gad-Nephtli, whereby they shall receive the blessings of Understanding in Shamoúnn-Ayshshur. **Through these partakings of the Trees of Knowledge, the eyes of RAúwaben are set to escape the corruption of the world and to serve the members to have vision into the States of Light to which they belong.**

## Day Six

In **the sixth day**, the House of the Staff is set upright, with the fruit upon its sides. Herein is **the House of Maneshayh and Yishshakkar are set, for the Body of the Staff has now been formed**, and the owner, from whose sides the body of its joined Names has been built, shall enter into its tent as one enters into the Shavbeth/sabbath. When the House of Yishshakkar is set one is engaged in their callings and in the works of their Names. In like manner, shall the glory of YæHúwaH enter into the congregation of Names as they are assembled as the branches upon the Tree of Lives. Until a body has been formed, there is yet a place to be made for the Meshiæch to lay the unified Heads of Understanding, but great is the rejoicing in the day when the founding stone is placed upon the Body that has been prepared. The founding Stone is the 8 of HhaTsur/The Rock, of which is Maneshayh Yishshakkar. From these united stones, come the resonance of all in ARAL, whereby the Temple is built. As the foundational stones rise to the crown, the fullness of Meshiæch has come, and the aúwt of Núwach is complete. Thus, as in the days of Núwach, to branch forth the Kephuw/Υ, comprised of the branches of Yapheth, Cham, and Sham, so are the days of Meshiæch.

The capstone of the Temple is the Oyin ○ in Yishshakkar, crowned with the Shayin W of the Lamb, which is the Head of the Body. **As each branch is set into its place, the full consciousness of all within rises, and great is its Light. In that Yishshakkar is the Works of the commandments, the full Light lies within the Hands of the Staff.**

## Day Seven

**In doing the commandments, the Light of the Shayh/Lamb breaks forth unto a new day—unto the 7th day of ARAL's habitation/shabbet. In the 7th day all things are as they are given by Aharúwan. From the beginning of AL unto the end of AR, all things are spoken. The utterance comes from the Head (beginning) unto the Foundation (the end). From the Fountain of Life in the Hhúwa, at the foundation, all that is spoken rises into the Shayin-Oyin at the Crown.** Through the rising of all spoken unto the end—unto perfection, the end is now the same as the beginning, whereby what is in the Beginning is now in the End. When the end is *as the beginning*, then all that has been spoken unto the end is conformed/aligned to AL, whereby it is said that the end is as the beginning. What is in the end is the manifestation of the offspring of HhaALhhim—the complete opening of the Seed Word of AL. Until the end comes, that which has been spoken is yet to be fulfilled. However; when what is spoken is manifest from Fire to baptism in Water and then to baptism in Fire, to be offspring of HhaALhhim, then the full revelation of all spoken is according to the Beginning, and the End of an Age is at hand.

From each pairs of Days, the Unified of the 70 Kuwáhnim speak through the Body of HhaALhhim. The Values of  $\approx/5$  appear midst the pairs of Days, conveying that the Kuwáhnim speak through Light into Rings of HhaALhhim/Elohim/Gods. The 70 Kuwáhnim are contained in the 07 of Aharúwan in which are 70 Names to be brought forth with Oyin. Messages of the Days are declarations of the manifestation of the Offspring of ALhhim, unto which creations travail to be revealed. The 00 in **07** and **70** forms saces of Maneshayh and the state of abiding Duo Consciousness of one's mission and sense of belonging to the Collective House of YæHúwaH.

The Tæyth/⊕, or the 9th House of the ALhhim, are the Shayin-Semek ring, for within them are the nines of the Consortium of the Lights. The Shayin-Semek and all within them carry the value of 9:  $21+15=36/9$ ;  $20+16=36/9$ ;  $19+17=36/9$  and the  $18+18=36/9$ . From the house of the Shayin-Semek comes the months/⊕ of the year, each of four quadrants, as the stars move into the path of Shayin and circle in the paths of the Semek. ***In the Houses of the Shayin-Semek are the fruit of the Tree of Lives and their kind:*** namely *the fruit of judgment/decision* in which is peace and self-control that is borne upon the branches of the Shayin-Semek; the fruit of the Rayish-Oyin: *conscious service (love) to one another*, with steadfastness/faithfulness and enduring patience and kindness; the fruit of the lips of the Quphah-Paúwah from which comes praise and all statements of eternal glory, *bearing the fruit of goodness* that is only found in the collective state; and *the fruit of liberty* which is the full measure of joy, being of the Tsædda-Tsædda. ***Those who eat of this flesh shall not die but have eternal life;*** but those who eat of the flesh of the beast shall carry within their thoughts the nature of the flesh that perishes.

The Yeúwd/⌘, or the tenth House of the ALhhim, is the House of the Rayish-Oyin. Amongst this house are the Shepherds of YishARAL for they bear in their minds the consciousness of the flock. Being of the Yeúwd, they do the work/labor of Yishshkkar, being of the kuwáhnute/priesthood, and all services with full devotion to AL. Also in this ring of consciousness are the 70 Alders/elders that abide within the rings of Light.

The Kephúw/Υ, or the eleventh House of the ALhhim, is the House of the Quphah-Paúwah in which are the servants of the Laúwim/Levites and the prophets that speak the davar/Word of YahúWah as they are fed the words from the hands of messengers. In this House are the 24 Alders that encircle the throne of AL and the Shayh/the Lamb, for they abide in the midst of the Tree of Lives that comes out from the thrones in the Dallath. Within the Quphah-Paúwah are the songs that are sung to whom they are given. These songs are the consecrated words that are only spoken by the undeceiving and blameless mouth, for no other can receive or learn them [Chazon/Rev 14:4] for their tongue is not able to speak them.

The Lammæd/ℓ, or the twelfth House of the ALhhim, is the House of the Tsædda-Tsædda, the state of Liberty to those which love the Túwrahh and the teachings of the kuwáhnute/priesthood. The fruit of Ayshshur, that affirms and secures all things, resides as the testimony of the ALhhim and all that is upon the branches of the Tree of Lives. In the Lammæd abides the inner revelations that are opened to the mind that is bound to the Túwrahh, which is the yoke of Light. Out of the Tsædda-Tsædda come the 12 fruit, one for each month, as the branches are filled with the Lights of Wisdom and Understanding.

# The Unified Ones Speak Days 1 - 7

All Days are Spoken in Pairs 1&2, 3&4, 5&6 unto their fulfillment

The Unified Ones of the  
The 4 quadrants  
of the Kuwhænim/servant masters

DAY ONE

EVENING OF DAY ONE

The Unified Speaking  
HhaALhhim Neúwn-Chayit

The House Declared  
**The 9<sup>th</sup> House Beniyman**

MORNING OF DAY ONE

The Unified Speaking  
HhaALhhim Hhúwa-Gammal

The House Declared  
**The 3<sup>rd</sup> House Zebúwlan**

DAY TWO

EVENING OF DAY TWO

The Unified Speaking  
HhaALhhim Kephúw-Kephúw

The House Declared  
**The 6<sup>th</sup> House Gad**

MORNING OF DAY TWO

The Unified Speaking  
HhaALhhim Dallath-Dallath

The House Declared  
**The 12<sup>th</sup> House Nephleti**

DAY THREE

EVENING

The Unified Speaking  
HhaALhhim Mæyim-Tæyth

The House Declared  
**The 7<sup>th</sup> House Aparryim**

MORNING

The Unified Speaking  
HhaALhhim Qúphah-Paúwah

The House Declared  
**The 1<sup>st</sup> House Yahúdah**

DAY FOUR

EVENING

The Unified Speaking  
**HhaALhhim** Tsædda-Tsædda

The House Declared  
**The 11<sup>th</sup> House Ayshshur**

MORNING

The Unified Speaking  
HhaALhhim Úwah-Bayit

The House Declared  
**The 5<sup>th</sup> House Shamoúnn**

DAY FIVE

EVENING

The Unified Speaking  
**HhaALhhim** Shayin-Semek

The House Declared  
**The 10<sup>th</sup> House Dan**

MORNING

The Unified Speaking  
HhaALhhim Zayin-ALphæh

The House Declared  
**The 4<sup>th</sup> House RAúwaben**

DAY SIX

EVENING

The Unified Speaking  
HhaALhhim Mæyim-Tæyth

The House Declared  
**The 8<sup>th</sup> House Maneshayh**

MORNING

The Unified Speaking  
HhaALhhim Rayish-Oyin

The House Declared  
**The 2<sup>nd</sup> House Yishshakkar**

DAY SEVEN

The Unified Speaking  
**HhaALhhim** Lammæd-Yeúwd

The House Declared  
**The 7<sup>th</sup> House Lauíwi**

What can we expect to be at the End of an Age? And when shall the End come upon us? The End/Harvest comes when all branches have been set unto the pairs of the Lamb/Shayh, and not until. When branches are set unto the Heads of the Foundation of the Staff, then the end is upon us, and shall swallow us up as serpents of Metsryim are engulfed by the radiance of Aharúwan's Staff. As branches are aligned with the SeedStone they are set unto Shayin-Hhúwa of the staff, at which time they partake of what is called the marriage supper of the Lamb.

For who can eat of the Body of the Shayh until they have come to the table, and who can come to the table unless they have clean hands and their garments properly attired by Perfect Associations? When your branches are fastened to the Tree, as Yahushúo is fastened to the Staff by the hands/deeds and feet/progressions in Light, then you eat of the abundance of AL and AR who serve you from the Head unto the End. Being joined and fastened, you tap into the Springs of Eternal Lives, drinking from the very One Body of Names unto whom you are called.

The banquet table is the Staff. Six shall sit on one side, and six shall sit on the other side, face to face. At your head and at your feet shall be hhameShiæch—your full measurements. hhameShiæch shall wash you feet; and the Priest of AL shall serve your head into whose lap you have laid your thoughts. You are ready to eat when your Oyin Mind of Yishshakkar has entered into the Mind of Aharuwan, and when your \Loins of Maneshayh have entered into the Body of the Kaiyuwer/Laver through which you are washed completely. For in the Laver you wash your feet first, but then your whole body, that you may come to the Altar of holiness and rise out of your former dwelling. How do we know when your Mind of Yishshakkar has entered into the Teachings of the Kuwahnim? We know you by your deeds of Light and by the Words that come from your tongue. How do we know that your feet are washed in the waters of regeneration? We know that you have clean feet in the manner in which you walk. Hereby the sheep are separated from the goats, for the goats will go where they will, but the sheep will follow after the Voice that carries the Staff.

### The Sending Forth of the 12, Two by Two

According to the Understanding being spoken within the congregation of the Staff, the Staff begins to rotate. The rotation of the Lammæd causes the bodies of Light, formed at its side to spin into their Lands, as Seed that is sown from its sides. According to the rotation, the camps are positioned around the mishkan and rise into a Ring of Stars around the Head of the staff. That which has formed within the Lammæd becomes fully known through its planting, whereby great is the glory of all that is within the Seed of AL. The Trees, from the planting, become evident upon the third day as the Voice of the Lammæd speaks according to the Ring of the Unified ALhhim. Each day the Unified ALhhim speak. As the Unified ALhhim speak for seven days, the complete acts of HhaALhhim are set forth and performed unto the Shavbeth/Shabbat.

Seed is sown to be born upon sides of Lammæd; branches are positioned to appear in their third day. The third day is an activity of Knowledge. To say that Trees yielding Seed are brought forth upon the third day, indicates that the plantings of HhaALhhim are according to Knowledge of the Fruit. The fruit bears within it the Seed, which is the testimony of its Origin



[SMB/Gen 1:11-13]. As the Unified ALhhim speak from their gatherings, the Earth—the lands designated for the Trees—bring forth expressions of that which is sown in ten lands. The Lammæd rotates during the course of 7 days, whereby all Names upon the Branches of HhaALhhim have been sent forth, two by two, unto the work of their Names.

Upon the first day, the Unified ALhhim of the Neúwn-Chayit and the Mæyim-Tæyth speak as one voice. Together they cry aloud with the grace of AL, whereby the Seed that is within the Fruit of Maneshayh is opened. The speaking of the grace of HhaALhhim opens the Seed of Beniyman from within the House of Maneshayh, whereby there is Light, for the opening of the Word, which is the Seed of AL, gives Light [Tehillah/Psalm 119:130].

One tribe of each pair is set first, from which the other tribe is drawn out from its side. So are Names set as pairs of one another from two sides of the Tree. The process of drawing out of each other is the means to form a rod for each pair, whereby the full measurement of their Names are known, and the fruit of their Names multiplies. As the Lammæd moves counter-clockwise, within the whirlwind of Fire, the Fruit of the Lammæd are positioned to abide together for the full extension of their Names. Until the Fruit is sown, it hangs upon the sides, whereby its glory is yet concealed.

Rotations of Lammæd is from the Heads of Understanding, from which are the Pillar of Fire and the Pillar of the Cloud. The Pillar of Fire is the Neúwn to the Shayin and all of the Letters in their midst; the Pillar of the Cloud is the Neúwn to the Hhúwa and their Letters. As the Heads of the staff move, so does the body follow thereafter.

In the fifth day, upon the speaking of the Unified ALhhim of the Shayin-Semek and the Rayish-Oyin. The House of Dan spin unto their location in the north. The House of Dan moves from the Shayin three spaces and is set into its place around the Mishkan. Upon the position of the House of Dan, the hours of a day are determined, for every function/hour is discerned by the Breath of Dan. The Breath of Dan activates Adim upon the sixth day and sets into motion the Age of Expansion within the aúwt of Núwach.

### The Rings in the Hours of a Day

**There are 12 hours in the day** (Yahuchannan 11:9). **Six hours in the evening in the Light of the moon, and six hours in the morning in the Light of the sun. These twelve hours are one united act—day of light** [SMB/Gen 1:5].

The word “hour” is derived from the word, 4Y4/aúwer/light. There are 12 hours in a day, one for each of the 12 Houses of ALhhim. The 12 hours are spun as 12 rings of HhaALhhim; together they are the House of Light. Each Ring of Light is an aúwer/hour of a day. The Light of the hour is a color/hue of HhaALhhim, as an Eye, through which the Light of the hour shines. The first hour is Dan, occurring just after sun set. The hue of the light is bluish in tone. The second hour is Ayshshur; the third Nephethli, the fourth Yahúdah; the fifth Yishshakkar; the sixth Zebúwlan. These six hours compose an evening in which Understanding resides richly. The seventh hour is as the sun rises, reddish in tone, of the Eye of RAúwaben; the eighth hour of the Ring of Shamoúnn; the

ninth hour, Gad; the tenth hour, Aparryim; the eleventh, Maneshayh; and the twelfth, Beniyman. As the body parts are rings, so are the hours. These hours are filled with Lights of Chækúwmah in which attributes of Wisdom are released and gathered.

In these twelve hours there are no darkneses, for they are the radiances of HhaALhhim pure Light. The House of HhaALhhim is called the Body of the Lamb/Shayh/אֶלֶף, for it is the dwelling/Bayit of the Hhúwa/moon and the Shayin/sun as one House. There is no need of a sun nor moon within the Temple of the Shayh/Lamb, for in the Body of the Shayh the 12 Houses—which are the Lights of the Staff/Lammæd/12, are fully shining. There is nothing to hide or dim the Lights as in the Beginning. The natural world which hides the Lights under bushels of skin is overcome by your inner radiances.

There are 12 hours for a day whereby a day is of Wisdom according to the ROD—the Lammæd of 12. The months are according to the Lammæd of 30, whereby a month is a body of Understanding. A day is measured by Wisdom (Tehillah/Ps 90:12); a month by Understanding, and a year by Knowledge.

Evening and morning make one day; 6 hours in the evening and 6 hours from the morning. In the midst of the evenings and the mornings is the Rod as Lauwi around which the Lights turn counter clockwise in evening and clockwise in morning. According to the rod/instruction there are six branches on one side and six on the other whereby there are seven or a complete day. These branches comprise the 7 branches of the menurahh, six per side joined to the central staff of Lauwi as one piece of gold. The Rod of Lauwi causes movements of rings of planets/stars and their Names of Light. The constellations also move around the ROD of AL instead of revolving around the sun.

The Rod stirs up the waters from Maneshayh in the midst of the 6:6 Houses for washing/activating the parts in the Hhakaiyúwer/laver for an oylah. From the stirring of the waters, comes the practice of passing the rod over another, whereby the waters are stirred within their basin.

With an evening starting with DAN, the morning commences with RAÚWABEN when your eyes open at day break. The evening begins with the Ring of Fire—House of Dan; the morning begins with the eye opening—House of RAÚWABEN. The last tribe in the evening is Zebúwlan; the last tribe of morning is Beniyman—the 12th hour when the seed-harvest is reaped. Everything starts with Wisdom and concludes with Knowledge as it is imparted and moves by Understanding. Until the Rod moves, nothing moves, whereby instructions are your force of change.

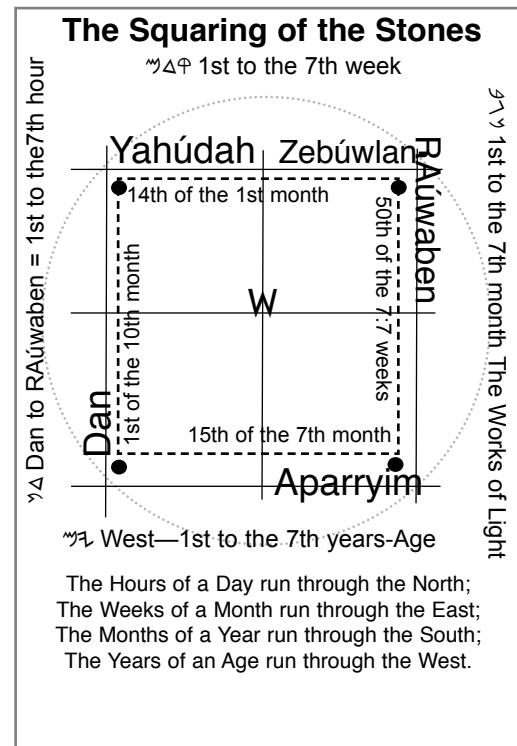

The 7th hour is when the Zayin opens the ALphæh whereby you are awakened. The tongue/I of Zebúwlan kisses the eyelid, and the eye/Ā of RAuwaben opens. In the 7th hour the tongue receives the Word upon its table whereby you speak what you learned while sleeping. The 7th hour is the measure/portion halamanekhiah Light whereby completion/perfection comes in your Seven Rings. The hours of a day are not limited to this realm, though they correlate to evenings and mornings , we do not limit the hours of the Rings to this realm.

The stones of the breastplate are arranged in a square, in 4 rows, three per row. The word row means route or path. The House of Laúwi is in the midst, and hence is not in the path itself, for it is the path through which all travel. The House of Yúwsphah receives a double measure of the staff for it is next to Laúwi. As the staff folds from one end to the other, so there are two measures, Wisdom and Knowledge, which are imparted to Yúwsphah. These are the waters above and the waters below, whereby there is the continual flow through the Rod. For if there is only the water below, and not above, the waters below would burst and be lost. There is a path for the distillations to return to AL, whereby what is spoken returns with a harvest. Where the waters are gathered is called a well, referred to as the wells of salvation. In that the waters are gathered within us, so we have our hope of salvation. Out of the waters below bread forms from your Seed which is eaten by the Mind above.

The hour of Yúwsphah is doubled every day; this is the drawing out of the lights in what is called the west. Not all hours are the same duration. The hour of Beniyman is the shortest hour of the day, whereas the seventh hour, of RAúwaben, is the longest of the day; being of the Zayin, whereby the full length of the Rod is cast. The length of each hour is determined by its position upon the Rod.

As to orientations, east of an evening is called the west, and the east of a morning is called east. The corner of the earth is where the sun rises in the morning and sits in the west at sunset, whereby it is the east of an evening. The eastern gate is the direction that we face for the daily offerings through which we are blessed according to the measure of the Rod.

The stones of the breastplate are an arrangement of the camps and their correlation to the rings of HhaALhhim. There are 4 rings that hold the breastplate in place; two at the top and two beneath. The four are the rings of Wisdom, being gold. The upper rings are the Zayin-ALphæh, and the Úwah-Bayit Rings. The Rings beneath of the breastplate are the Hhúwa-Gammal and the Dallath-Dallath. This is a breastplate of Judgment, and hence of DAN, for these rings are within the Shayin-Semek Ring of Dan as they are in the mind, prior to being extended into the body. The first path/row is the state of non-partiality, the side of the north. There are 4 rows of three stones according to the paths of the north, the east, the south and the west.

With gratitude to AL, our saviour and guardian all of our days, we are not forsaken in a foreign Land. We must cleanse the minds and the documents that have been formed with the clay attached to the wrong ring. We must separate the clay from the iron, so that we have the where-withal to form a body of immortality. The Bread of the Faces is now clear. Each loaf is distinct and comprised with the Letters. There are 6 loaves for the evening and 6 loaves for the morning, one loaf for each hour of the day.

### The 10 Steps within the Rings

There are five steps on each side of the Ladder of Yaoqu/Jacob. Through the steps we have access to all of the Rings of HhaALhhim, whereby we are extended through Understanding from one end—the base of Wisdom, unto the other end—the crown of Knowledge. The steps of Light are amidst the Letters of HhaALhhim, through which we ascend and descend upon the ladder. **The steps are known as the Midrash/inquiry to Revelation, termed as HhaBayitAL (the House of AL), proceeding from AL to AR and AR to AL.** AL is the revealer; AR is the means of revelation. In the midst of ARAL are the 10 curtains/*spheres of Light* which form the House of AL. The curtains are the properties of the OYIN/O which hang upon the Zayin/I, whereby the ZayinOyin Body is formed/IO. Together with ARAL, the ZayinOyin formulates by the consciousness within the Heads of AR and AL being hung upon the Zayin. The hanging of consciousness hung upon the Zayin forms a body for the united Names of ARAL, and becomes the dwelling State of ARAL. Hereby is the Name of ALOZAR/ אלוזר. From the hanging of consciousness comes the hanging of the veils in which all Names dwell in the Tent of Meeting.

As you seek within the Rings, you are guided step by step in sequential order unto answers. The answers are grouped together, like cities, conveying the Tæyth/⊕. From the four directions of Light you may come unto the city and thereby arrive at an answer. A city is where centres are formed, as information centres of Words of HhaALhhim that come together. **Each answer is the fruit of the Word, being comprised of many parts of perfection.** What one may think is the answer is often a first step to be positioned to attain unto the revelation that is opening within the singleness of eye.

When the Eye is One, then all rings are aligned together through which one may behold the answer. The answer is called, *megonah*/ מגונה, for it is obtained as an extraction of the Unified Eye/Ring through which the path of light is obtained. All revelation comes through the Eye. While 10 steps are portrayed within the Rings, there are 10 steps to every truth, whereby the truth becomes empowered within our hands. As the truth is evident in our deeds, we have the sign of attaining the full revelation that is opening within us.

The Letter Zayin extends from one side to another. The base and the crown of the Zayin are drawn out from the north side unto the south, from the side of mystery to the side of the full illumination. As the Zayin extends horizontally to release/give the ALphæh, the Ladder rise vertically also with each impartation of ALphæh Principle. The ALphæh rises unto the Semek which bends towards the Shayin whereby it is ignited. In this manner, the Zayin makes a square for each Seed

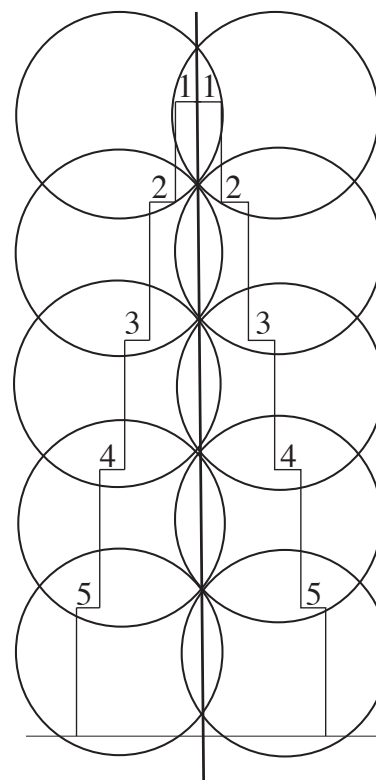

to expand within, whereby every side of the Thought is observed. The process of the ALphæh rising is the formula of  $1+1=21$ , which is the formula of “bone from my bone”—lit. bone increases as it is extended through the Yeúwd/hand/𐤆. Whenever one establishes a position and then extends their hand according to the position, they multiply the staff or the bone/𐤍𐤏 of the position. Those who are steadfast in the House of AL extend their inner core as a tree extends its branches. The branches are the bone of the main trunk extended, from which comes the saying, “bone from my bone”—𐤆𐤍𐤏𐤍𐤏. **Bone extension is the branching of a Tree of United Names.** The further one extends their bone the firmer they become, for the one who does the commandment is stronger than the one who thinks only about it but does not implement it. It is through doing the commandments that one increases in the strength of AL, whereby they cannot be lowered unto the impulses of the worm to proliferate and copulate within *the age of shadows*. As the bones are extended, one provides the spaces for the circles of garments to expand. Around the staff, the garments are spun as yarn from the spindle. In like manner, the Rings expand around the Lammæd, whereby they are filled with the Reuwachut/Breaths of ARAL.

### The Bone of HhaALhhim

The Formula:  $1+1=21$  Bone extension provides definition/clarity for a House of Light;  
The Core and the Branches, formerly rendered, “bone of my bone”

The Premise: The Zayin Ring is within the Shayin Ring.

The Eyes aligned. The inner Eye of the Zayin Ring within the surrounding Shayin Ring.

*The Fire to consume the world begins with a spark in Dan.*

The Result: The Bone of HhaALhhim. The Semek/skeleton is formed by the rising ALphæh from the Zayin. The inner core of the Semek is the chamber of Fire in which Dan dwells.

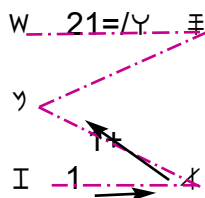

All spoken of AL is from the Zayin/7, whereby what is said is perfect, being seven. The perfect sayings come from **the perfect aligned Eyes** of Dan and RAúwaben, which is Dan as one, and RAúwaben as seven, through which all is seen from one to twelve. The alignment of the Eye of Dan, being the Shayin-Semek, and the Eye of RAúwaben, being the Zayin-ALphæh are the parameters rings of HhaALhhim. When these Eyes are aligned one is able to see all of the Rings within and thereby is able to see the movement of Light from the hours of 1 to 12, which is the Name of AL/𐤍𐤏, 1/𐤍𐤏 to 12/𐤍𐤏. Daily the voice of perfect Unity goes forth from the first hour of Dan to the twelfth hour of Beniyman. As our eyes are aligned with Bayinah and Chækúwmah, we are positioned to enter into the alignment of the Lights of Understanding for the hours 1-6, and those of Wisdom during the hours of 7-12. Our eyes are to be aligned with one another whereby we see one another as we are in HhaALhhim.

As one speaks perfectly/completely, the unified Seed of ALphæh is imparted in the midst of aligned stones, which are the foundation of complete bodies. The aligned stones are the Rock of

our Foundation that does not shift as sand. What does the foundation mean that it does not shift? There is solidarity to Oneness, without an avenue for separation. **The utterance of Seed is the first value of the formula of bone**; what is spoken is ALphæh/4/1. **Oneness is spoken and only oneness from HhaALhhim**. The response of the conscious head of meshiæch that is aligned with the Rings, refutes any suggestion of arrogance or shifting of the Rings which causes an obscurity in thoughts and expressions. Therefore, when Shatan suggest that we bow unto the principles of mortality—unto the prince/desire of this world, our response is from the Teúwrah—the composite unified writings of Light. “You behold the totality of YæHúwaH [the collectiveness] of your ALhhim [all Rings aligned], and the unified whole you serve, and in the unity of Name you are complete/swear—are seavened squared as your members are aligned one to another upon the altar of Fire [MT/Deut. 16:13].

The Eyes of HhaALhhim are registered, as aligned layers, upon each other, whereby you abide in Perfect Associations of YæHúwaH from day to day, from week to week, from moon to moon, and from year to year, unto the entrance into an age of development amongst the ALhhim. Each era and age is set by your brother member, Yúwsphah/Joseph, for as Yúwsphah is and where Yúwsphah abides, so is the age that follows.

Every temptation is a means to reveal what you are made of and the solidarity of your thoughts. We set-up our temptations to reveal our strengths, for they are orchestrated by the lusts within our members being examined [Yaoquv/James 1:14]. Lust is a misalignment of stones, whereby vision is skewed. Temptations are not of HhaALhhim, for if so, then there is no solidarity of the Rock, nor are the thoughts of temptations in AL nor in the Seed of AL. Tests and trials are not to be confused with temptations, the former being the means to perfect our soul. Temptations reveal our need of alignment, whereby trials reveal the character of Light in our Seed.

The ALphæh, upon being composed, is given to the Neúwn/14, as every Word spoken belongs to the directive consciousness, and from its midst the Seed flourishes into a Tree. The Neúwn/14 receives the ALphæh/1:  $1+1$ , whereby from its sides it brings forth Semek/15. Between the midst of the Semek and the Shayin is the value of 6:  $21-15=6/\Upsilon$ , whereby the Úwah appears in their midst. **Between all of the parameters Letters is the perfect bond of Unity that holds the sides together as one**: Neúwn and Chayit:  $14 - 8 = 6/\Upsilon$ ; Zayin and ALphæh:  $7 - 1 = 6/\Upsilon$ . The Úwah/ $\Upsilon$ , in the mathematics of Light is the same as an equal sign. In that the Semek/skeleton is formed by the ALphæh entering into the Neúwn, it belongs to the Shayin from which it is cast, as copper and iron, in the midst of the Fire to wield a sword and instruments of cultivation. In this manner the tongue is conditioned, hardened and shaped by the Fire, whereby it speaks the perfect thoughts of the Directive Consciousness. The Fire comes off of the tongue/Zayin and flames through the open spaces unto the Shayin. The vertical and horizontal spaces are required for the Fire to blaze as the ALphæh rises and fills the chambers with Fire, as pure Fire resides within pure space. The Semek abides at the side of the Shayin, which is its side, whereby the Fire is concealed within the Bones. Though one passes through the Fire, they will not be burnt. In this manner the offspring of the Oovri/Hebrews withstand the fiery furnace at all seven levels of intensity [DaniAL 3].

The dotted line in the above formula of Bone conveys the formulation of the three teraysaruns of Wisdom, Zayin to ALphæh; the teraysarun of Understanding, ALphæh to Neúwn; and the ter-

aysarun of Knowledge, Semek to Shayin. The framework of Light forms three pyramids, whereby the expression of Light is multiplied and fills the spaces unto which it is designated. Some ideas do not form a structure, and being as a worm, they perish in the heat of the day. Other ideas arise within us are of AL, which form the bone unto which we may hang the flesh of our expressions and bring the spoken Seed unto maturity.

As a Seed is sown from the Sower/Zayin, the values of Unity are brought forward to become clothed/expressed. In this manner a Seed brings forth the bone, or root, of the plant prior to putting forth its leaves/garments. The bones are the branches of the staff. The root is the primary branch of Understanding, being Chækúwmah. Through the root system, the 7 pillars of the House of Wisdom are laid in place to be clothed with the garments of Light. The roots are the foundation of the House of YæHúwaH. The root is the Zayin to the ALphæh incorporating all 7 Letters from one side to the other. The rays of Light are the Zayin, for they open the ALphæh/seed as the tongue opens the Word. The Light is the carrier of the Word of AL; the light rays open the Seed, being the Zayin of the Staff, or the root of the Staff which causes the shell of the seed to open and release the Body of Bayinah unto Knowledge. The tongue, as the ray, can go into any realm of the Mind of AL; it may measure the same as the Staff in that it can be drawn out the same length as the staff. We also must have the bone or structure of thought—the bone of HhaALhhim, whereby we are able to bring forth the garments/expressions of glory *through the performance of the commandments*, for it is the hand that weaves the garments for the bones.

From the Zayin, a tree brings forth the root from its midst. As the ALphæh rises through the Neúwn, it forms the Semek, of which are the bones of Fire. The bones being of Fire, the garments and the fruit, being the flesh of the bones, are also be of Fire. ***The bones are the crystallized thoughts of Breath coming from Dan.*** From these pairs of parameter Letters, Zayin and ALphæh, Neúwn and Chayit, and Shayin and Semek, all offerings of Fire are composed, which are the words of Life and the deeds of keeping the commandments. **According to the Bones and the Flesh of HhaALhhim all of the oylut/burnt offerings are performed as the acceptable offerings of YæHúwaH.** Until we are of the bone of AL, we are unable to bring forth the fruit of the Spirit, nor do we know how to perform the commandments until we have the core thought formed within our midst. We learn how to dress the Tree as we bear upon our shoulders the Words of HhaALhhim. Every commandment is to be studied, for they are the means of expressing the glory and radiance of the Mind of AL. Upon the bone of Ahhav/Love—the inner core of the Túwrah, all of the commandments, as fruit, hang upon the inner core of perfect unity.

The Semek is the inner core of Shayin, whereby Fire is contained within the bones [YirmeYahu 20:9]. Herein do we comprehend that the Breath comes according to the Lammæd and takes its seat within the Neúwn through which it flourishes through the gate of Beniyman and by the Seed of Beniyman that comes through the gate, which is the gate of Neúwn. Thus the prophet sees the bones first, then the garments, and then Breaths coming forth to raise the bones and the garments as the Mishkan tent of meeting [YechezqAL/Ezekiel 37]. Breaths, being inner Intelligences of Seed as Queens to govern night and day, do not come until a body is prepared for it to reside in, nor does the Shekinah Glory of AL come until a perfect tent of aligned associations is built by their offspring into whose hands hold the fruit to form a temple. The Breaths will not accept an offering not made of Fire nor a house to rise in that has within it leavenings of self exaltation. Breaths will forsake this house and call it Ai-kabad/אֵי-קָבֵד— the glory has departed from YishARAL.

Out of the graves of mortality the House of YishARAL arises unto the 10 Lands—the states of their inheritance formed as fine linen from the Seed of AL. The lands are spun as the Seed of AL opens. The Light, being the Life of the Seed, begins to draw out the thoughts within the Seed, as spider that makes a fine web. The Lights/Aúwerim are of Wisdom and Understanding, Understanding emitted from AL, and the Light of Wisdom which comes out of AR in which Bayinah dwells. For all things have a dwelling state. Bayinah dwells in AL within Aharúwan; however, when Bayinah runs like a river from the mouth of AL, Understanding takes its dwelling state in Chækúwmah and from there regulates the dispensation of all thoughts within the Seed of AL. As the thoughts of AL rise unto the crown, Understanding follows thereafter and abides in the Seed of AL again, from which it is in the beginning.

The Shayin/Fire creates the inner core structure/פ which is the House of the Fire, these being the inner layers of the Staff. Each Letter draws out of itself to form a dwelling, even as we are shown by the opening of every Seed. The opening of the Seed of the Shayh/Lamb will create the Temple of YæHúwaH. Three inner core rings are in each bone, as illustrated above in this document, under the section of *The Rod of maShayh and Aharúwan*. The bone is comprised of two zeros: 0:0, in which are three rings forming the inner core and three rings forming the surrounding core. The value within the rings is 7:7; however the space in which they being both of Wisdom and Understanding, the bone is 0:0, formed by being mouth to mouth. From Nothingness to Nothingness, the state of a new creation and a new age commences as we take the bones of Yúwsphah, being 12, and arise out of our former definitions, which are states of our sojourning.

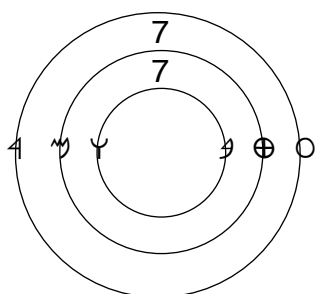

The 3 Inner Rings  
2 x 2 = 21 Flesh of Fire

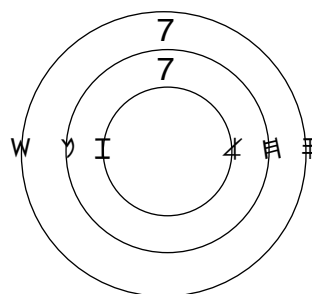

The 3 Outer Rings  
1+1 = 21 Bone of Fire

### The Mishkan in the Mind of AL

### The Values of the Cube

As the Zayin expands the foundation in all directions, a cube forms. Within the cube are the 10 circles of the OYIN hanging upon ZAYIN. In viewing the 10 curtains from a corner, the three interior houses, or pyramids, within the cube appear. One beholds the Houses of Wisdom, the Houses of Understanding, and the Houses of Knowledge, being together in One paradigm of Light. Each side of the cube is 16 squares, the value of the Oyin that is within it. From the six sides of the cube there are 6 x 16 = 96/15/6 windows into the cube and 96/15/6 windows in the



midst of the cube. As one passes through the midst of one of the ten lands, they go from one level unto another, as though one is descending and ascending upon the Ladder of Yaoquv.

The value of all spaces on the surface of the cube is the permutation of  $16 \times 6$ , written as 96, a Value of 15. The same formula pertains to all of spaces on the inner wall of the cube. The formula of the paired Names, those around with those within are  $(2 \times 96)$ , as all Letters, which are arranged in pairs, pertain to Cohesive Paired Principles in their Residences. The Letters, as they unite, form an Eye in which they dwell, whereby we deduce that we do not see until we are united with the Bone and Flesh of our Names. As the Body of HhaALhhim, we abide within a seamless Oyin sheath of Light. Though the Eye is apparent only, all other members of the Heads are present, unseen, for they are of that Mind of the HhaALhhim to be of singleness of Eye/O, seeking not to see apart from the whole. There is no need for self projection to be noticed; we behold one another in purity and with elucidation whereby nothing is obscure.

**The cube** is composed of the 21 Letters of HhaALhhim, arranged in 4 rows per side. Each row is composed of a pair of Letters, an inner and outer set that make up the Bread of the Faces. In each union of Letters, the Taúwah/X Letter appears, whereby they are joined. On the surface of the cube is the Shulchan Panayim—The Table of Faces, commonly called the showbread for they appear on the Faces of the cube. The potential union of the 21 Letters is the value of  $21!$ , being of 20/4 digits: 51090942171709400000.0, a reductive of  $59/14/5$ —the value generated by the Lights of Knowledge/59; the Lights of Understanding/14, and the Lights of Wisdom/5. This integer conveys the value of all thoughts, being composed through the unique combinations of the Letters. Essentially, this is a measurement related to the Mind.

**Faces of the cube** are 6 per side, being 12 all together. The Faces are for each side of the Staff/12. Each of the Faces is a value of  $16!$ , or 20922789888000.0, being a digit of 14 Numbers from which all Faces are derived and have the potential of 14 powers as detailed above in this document. The value of each pair of faces is  $2 \times 16!$ , 41845579776000.0, which is the sum of each pair of Tribes, i.e Gad and Nephthi. The value may be extended as the unity of two Names form an Oyin consciousness, whereby the value of their faces united is the same value. In that each Face is two parts, the Faces of a unified Name is 4, such as depicted in the vision of YechezqAL/EzekiAL. The reductive of the value is  $63/9$ , the value of 63 contains all of the Rings of HhaALhhim as detailed above in the section: The Rod of maShayh and Aharúwan. The value of 9 pertains to the number of threads that are woven by the Staff, which forms a garment for the united Faces.

The Consciousness of each surface of the cube is comprised of 96 squares, 16 squares per side, 6 sides being the squares around and 6 sides being the squares within. The two surfaces pertain to the two sides of Light: the Light of Wisdom in the morning and the Light of Understanding in the evening. The Light around is of Wisdom; the Light within is of Understanding. The consciousness of each Light is  $96!$ , being the value of  $9.91677934870949 \times 10^{149}$ , an integer of 150 numbers/digits, with the reductive value of 6 positions, one for each hour or house that comprises the consciousness of the Light of Wisdom, and likewise, six positions/hours/houses for the Light of Understanding. We hereby deduce that the strengths and values of Wisdom are ascertained only upon the unity of the 6 houses of

RAúwaben, Shamoúnn, Gad, Aparryim, Maneshayh and Beniyman. These members correspond to the 7th to the 12th hour of a day, from morning unto evening. When there is a fracture within these camps, the value of Wisdom suffers, creating a crack or fragmentation within the soul of the Name, whereby the soul may be affected adversely. When a fracture occurs, a seed concept, beyond AL, may be sown within a member. However; in the unity of the soul members that belong to the Light of Wisdom, the Seed of ARAL flourishes until the soul is possessed by the Mind of ALOZAR. The unified members move as a flock of sheep being directed by the side of the staff belonging to Wisdom, in which is “the cloud” by day. *The same value pertains to Understanding*, which is the inner surface of the 6 sides, in which is the “pillar of Fire” that directs the camps by night. The full values of the Light of Understanding is known as the members of Dan, Ayshshur, Nephethli, Yahúdah, Yishshakkar, and Zebúwlan are woven together as united Faces of Light for the hours 1 to 6, from evening unto morning. These inner camps regulate the expressions that come from deeds, in that these houses are the source of every viable meditation from which the commandments are written to affirm the Mind of ALOZAR. Those who perform the commandments are of the Light and are of the chavarim/friends of AL.

The parts of the Staff, six sections per side, comprise 12 parts, the sum of the Lammæd. Within the 12 is the reductive value of 3, or the three houses that abide within the cube—the Teraysarun of Wisdom indicated by the gold line; the Teraysarun of Understanding denoted by the silver line; and the Teraysarun of Knowledge, indicated by the copper line. As the Lights of the Hhúwa/moon/א and Shayin/sun/W within the Lammæd blaze, all parts of the Staff are ignited into the oylah of the evening and the oylah of the morning. The two lambs/*kevashim* per day are according to the Lights of Understanding and Wisdom. The daily lambs are the fruit of Knowledge which are born upon Tree of Wisdom and Understanding. Within each day’s offering are the number of the month and the number of the day. The values within the lambs contain the revelation of the Mind of ALOZAR, whereby the white pearl of Wisdom and the black pearl of Understanding sing the high praises of AL, as the values are released in the daily sacrifice. *The unified lamb of the Age*, offered upon the 14th/Neuwn of the Yahudah for Pesach, and as the means of renewal and fulfillment of a Name born, is the Shayh/אW, which is **the Lamb of Avrehhem** [SMB/Gen 22:7-8; SYM/Ex 12:3; TK/Lev 5:7, 12:8]. The perservation of the Shayh by Daúwid is the means of slaying Goliath and becoming a Counsel forever amidst the 12 [ALphæh ShmuAL/I Sam 17:34]. **The Shayh** is the offering required to lay a foundation for the succeeding aúwt of Yetschaq, which is offered by the Priest of AL before all ages or worlds are formed.

**The full value of the Lights within the cube** is  $2 \times 96!$ , being the value of  $1.9833558697419^{+150}$ , a value of 151 digits, having **a reductive of 7 positions**. This integer is the value of the length of the rod as one would unfold the two sides into one as from the Zayin to the Oyin. The length of the rod is the value upon full moon when the rod is fully extended from side to side. The length is one half this measurement when the Lights of Wisdom and Understanding side by side on the 15th day of the month, whereby they are 0:0, being mouth to mouth through which all is transferred from one dwelling unto another. The full value corresponds to the measurement of each universe in which all of the planets and bodies of Light belong unto the Staff around which they orbit.

The 7 Positions of Light are the 7 Rings of HhaALhhim in which the fullness of ARAL dwells from end to end. ***In the 7 Rings are first of 10 Lands of Avrehhem***, in which the Seed of AL abides and brings forth fruit of Wisdom. Following are the 10 States of Understanding of Yetschaq and then Knowledge of the advancements of Yaoquv. **The value of 10!** is  $3.628800^{+06}$ , having the reductive value of 7 positions. As the value of 10 is occupied within each Ring, the full measure of Meshiæch is known, which is the full measurement of the Oyin/Consciousness of the Word of AL, being 70, which is spoken upon the lips of the kuwahn-im and written within the inner parts of the people of ALOZAR.

## The Directive Consciousness

When we refer to mind, we are speaking of the ends of the poles that direct the pole in a direction. The awakened mind is in the Neúwn, which does not accept a mold to abide within which is outside the paradigm of the United ALhhim. In knowing the location of the pearls within the Neúwn, one may refer to the mind as the “**directive consciousness**.” The white pearl of the south is the directive consciousness for the morning; the black pearl of the north is the directive consciousness for the evening. What is typically called the mind are chambers of thought which are drawn upon by the directive consciousness. In all spaces of mind, there are the 48 enlightened centres of mind, known also as the cities of Aharúwan, which are positioned within the 10 lands. These 48 cities have within them the reductive power of 12 or the Rod of Aharúwan through which the lands are governed.

We are cast from the crowns of Alders. As their planting we bring forth the glory of ARAL. We arise from within Rings of HhaALhhim as trees. We come to know the Mind of AL, whereby we are of the same bone as AL. Until we know the “directive consciousness” of AL, we wander and become subject to the imagery of oneself apart from the collective. We are cast from AL to AR, to be nurtured within the Hhúwa-Gammal Ring of Wisdom. In this same manner Mashayh/Moses is lowered into the River through Bayinah, depicted as Maryim/Miriam, to be taken into the arms of Wisdom to be nursed by Yahuchevd/Jochebed. Wisdom feeds all that Understanding bears, and Understanding feeds all that Wisdom bears, as we feed from our corresponding sides. As one is nursed by Wisdom the brother of Enlightenment—Aharúwan/Aaron appears. The enlightenment comes to our side when we commit our Name to perform the mission and abide in our place according to the directive consciousness of AL.

**A Name is born amongst the Rings of HhaALhhim.** Around the Rings of Light is an ever rising mist, caused by the distillations of Breath within the Rings. Within the mist are reflections of all within the dwellings of HhaALhhim. The mist condenses and forms a pool of water each evening and morning at the base of the mountain of AL. This pool is called the moat around the Rings. The moat is the great gulf fixed between the Rings of HhaALhhim and the space beyond, called the outer realm. Within the mist are circles, and within them are smattering particles of thought as Light bounces off of a mirror. Through the circles one may draw out from the words being spoken amongst HhaALhhim. The fruit of all that is spoken is born upon the sides of the Rings from which they are transferred. As we abide within the Rings, we eat from the Trees of the Garden, each Tree being of the unified Branches of AL. As we eat of the fruit from the sides of the Rings, we partake of the Knowledge of the Rings.

# The XO9⊗/Tevot/Rings of Flesh of HhaALhhim

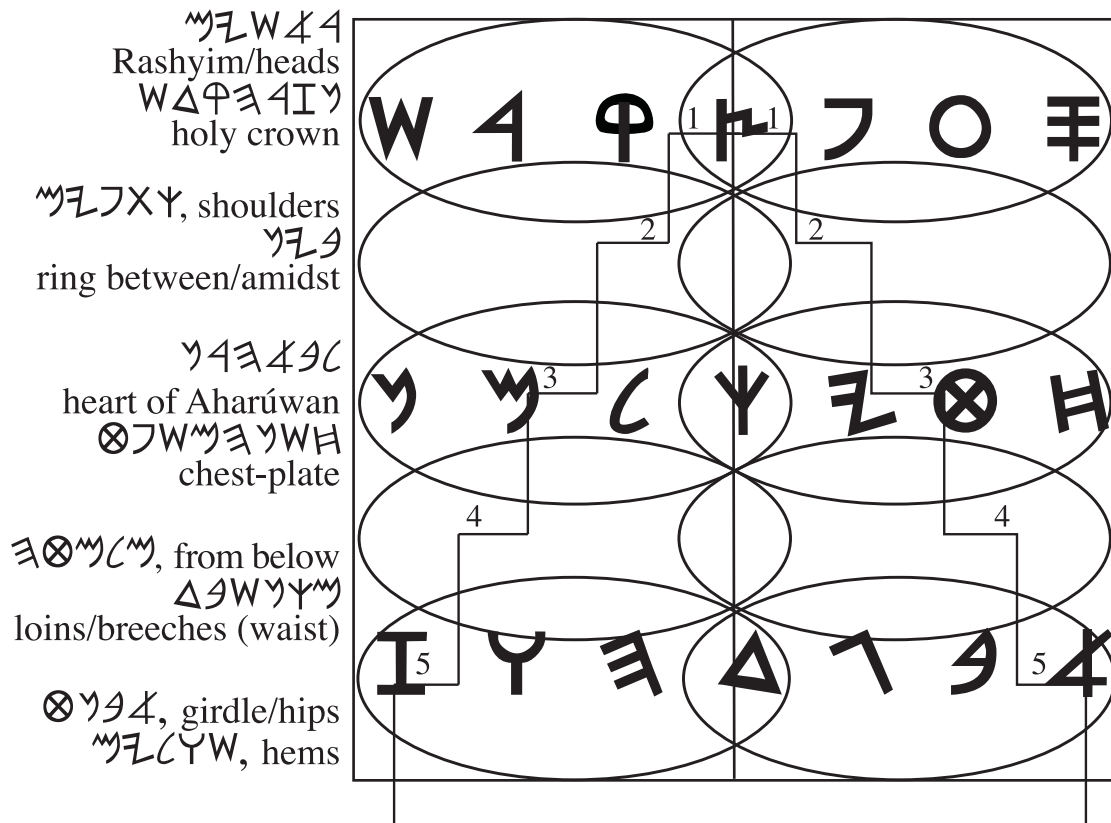

1 ʾלW44/Rashyim/heads, Chamesh HhaPekudim 7:2; XʿO9ʿʾ/turbans/layers of revelations, Sepher Yetsiat Mitsraim/Ex 28:40, 29:9; WΔφ34I7/holy crown, Sepher Yetsiat Mitsraim/Ex 29:6; X7ʿʾʾ/mitre, comprised of the Rings of Knowledge, Sepher Yetsiat Mitsraim/Ex 27:4;

2 ʾל7Xʿ/Kekethphyim/shoulders, Sepher Yetsiat Mitsraim/Ex 28:12; Δ743/the ayph’ phad/ephod, comprised of the Rings of the kuwáhnim, those for Understanding, Sepher Yetsiat Mitsraim/Ex 28:12; C7Oʾ X4/the robe, Sepher Yetsiat Mitsraim/Ex 29:5; 7ל9/ring between/amidst from which are the offspring, Sepher Yetsiat Mitsraim/Ex 28:1

3 7WH/Chashan/breastplate, Sepher Yetsiat Mitsraim/Ex 28:4; XʿʿʿX9/midsts, Sepher Yetsiat Mitsraim/Ex 28:32; ʿʿXʾʾ/from the midsts, Sepher Yetsiat Mitsraim/Ex 28:1, comprised of the Rings of Understanding

4 3⊗ʾCʾ/from below, Sepher Yetsiat Mitsraim/Ex 28:27; Δ9W7ʿʾ/loins/breeches (waist), Sepher Yetsiat Mitsraim/Ex 28:40;

5 ⊗794/Ayvenet/girdle, Sepher Yetsiat Mitsraim/Ex 27:4; ʾלCʿW, hems; Sepher Yetsiat Mitsraim/Ex 28:33; comprised of the Rings of Wisdom

Fruit of the Rings appears on the Tree of Lives each month—on the third day of each week of the month and during the later ten days of a month [Chazon/Revelations 22:2]. Should one eat of the fruit apart from the Trees, or partake for a motive that is not congruent with HhaALhhim, they eat amiss, and thus they do not partake of the Word itself. Those who eat what is appearing within the mist as reflections, are misled into forms and constructs which are not derived from the Word itself. From these reflections one gets carried away into practices and adorations that do not synchronize with the Paired Letters of HhaALhhim. Those which behold their own reflections within the mist, as one sees themselves in a bubble, look at themselves in part, and become drawn into the mist after their reflection instead of the Light itself that appears as a prism. This is the story of Narcissus who looks within the waters and is drawn after the illusive reflection of one's self. Such accounts remain within the consciousness to remind of how we went astray from the Union.

As the Light strikes the mist it is bent and fractured into segments of waves and frequencies within the mist of water crystals. As one feeds upon the retractions or for purposes not in tune with AL, they do not feed upon the sides, to which they are committed by Name and lineage, and having eaten apart from the Tree itself, they begin to slowly die having no food from the Rings. The result is famine as that occurs within the House of Yaoquv, that is within a Name. The famine come by no longer eating from the united branches of the “directive consciousness” of AL. When the House of Yaoquv is divided, and the garment of their collectively ripped, depicted by the tearing of the garment of Yúwsphah/Joseph, the members come into famine from not hearing the Word of AL. In that they are no longer feeding from the Rings, they forget their former dwelling, having become citizens of another state. According to the division within their branches, they are moved from the circle of Kenoni/Canaan—from one of the ten circles, in the midst of the left side, unto another world.

### **Eating unto your Lives or Deaths**

When one partakes apart from the Tree of Rings, they are no longer joined to the SemekBone of Yúwsphah/Joseph, through which Lives of the Tree flows; and hence, they become as branches broken off from the trunk of Understanding subject to famine. As one eats from imagery within the mist of their own projections, they feed from that which is within themselves, through which they turn themselves inside out and form a body of mortality in which abides death. Until then, they are invisible, being of the Body of AL. Coming into the Grave/Body of Mortality is the “second/affirmed death,” for it affirms separateness from the OoDann/Garden of the Tree of Lives, a dwelling apart from the collective Unified Body. In the body of mortality the mind is projected without a covering; therefore, it is naked. The internal aspects—being the faces of a Name—turn inside out. Due to the separateness from the collective, there is no shame in their faces, being of character as proud and haughty even though they are blind and deaf; such is the nature of mortal flesh. Turning outside IN, connects you to your first death state of your Seed giving itself in the OoDann Garden to comprehend the Tree of Lives which is in your Seed.

Within the Rings of ALhhim we partake from the other side of the Tree to which we belong, and do not eat at the table of separateness. *We feed each other as the sides of HhaALhhim feed*

*each other: E.g.* The Zayin feeds the ALphæh, as every action of the tongue is unto bringing forth the Principle of AL to nourish the Lights in Seed. The ALPhæh feeds the Zayin with the grain that rises within its Head whereby the tongue is satisfied with abundance. “***As one speaks, so one eats.***” This is a saying of Zebúwlan, whereby the Land is filled with the abundance of Beniyman. The Shayin feeds the Semek with properties of Wisdom, and Semek returns unto the Shayin as fruit forms upon its sides. In this manner, every Fruit*ofthe*Body is formed, whereby the properties within one side of the fruit builds up the other, until the fruit is complete and runs with its blood. In feeding one another, we demonstrate the pure devotion that exist from side to side within the Rings of HhaALhhim. The devotion of HhaALhhim to one another is the love of YæHúwaH that is shed abroad from side to side. In feeding each other through the eyes, we form a square, whereby all perceptions can be tested from every side through aligned stones in agreement one to another. In the perfect Unity of all stones, we resonant the Heads of YæHúwaH in all camps/sides, whereby all sides are aligned with HhaTsur/The Rock of foundations. Through feeding side by side, we have thoughts of wholeness and are continually renewed with an ever supply from the sides of Unity. In the Union of Names we supply each other as branches upon the Tree of Lives, being bone unto bone.

As one pursues imagery of self projection in the mist, apart from the whole, their faces/expression follow according to all traits of selfishness. They bring forth faces of division. As they leave the Rings of Aúwer/Light, their back is turned away from the Lights of Unity. Though their faces are dimmed from shadows in which they walk, the arm of YæHúwaH is not shortened that it cannot reach them. Though they walk away, the similitude of the Lights surrounds them in the bodies of the moon and the sun to awaken them unto who they are and to whom they belong.

We abide to affirm being joined Names to Names, lest we make an abode apart from the collective. We abide either within the Faces of HhaALhhim, or we project our own faces apart from the Body of Light. **In returning to the Rings of HhaALhhim, we do not seek to preserve the world or our faces of mortality, nor do we seek to project our separateness.** The way to return to the City of HhaALhhim is via the waters of similitude to that which forms as a pool at the base of the Rings. The waters of immersion/baptism are entered to put on the garments of Light. In the waters of similitude, we bury the former state and rise with our faces resolved to the Faces of HhaALhhim. We who enter the waters of similitude turn our faces to the Faces of HhaALhhim that we may again be clothed with garments of Light. In our awakening we walk as those apart from the faded rags of mortality that are woven through separateness. Though we yet abide in a State between two worlds, we behave in all ways according to the citizenry of the House of AL, unto which we are called and Named. Stories of Narnia, by CS Lewis, convey the consciousness of moving between worlds through the change of garments, as one passes through a wardrobe. Garments of mortality are laid aside. Daily as we make the oylah ascendant offering we wash/activate our Garments of Immortality by the blood of the evening and morning lamb, whereby we are renewed in all ways to the union of Names.

As one continues to walk into the mist of reflections they create a shadow before their faces. In living within the world of refractions, they abide in shadows of deep darkness. Every step away from the rings must be retraced by following the trail of one’s own blood that was walked upon, disregarding the very Life within oneself. Through each progression,

Understanding returns. Every step toward AL brings one closer to the Rings of Auwer, whereby the illumination of Aharúwan/Aaron embraces them, as Mashayh/Moses is embraced by the unity of his brother. The Light that they turned their back to shines again within them, for this is the Light of their Name, being of the Lights of HhaALhhim from whence they are born. The pure Light of HhaALhhim within them fills their garments with the Lights of the Staff/Lammæd/12. The staff guides them through every act/day through which they perform the works of HhaALhhim and thereby bring forth the Faces/expressions/fruit of Yehu and their HhaALhhim. In accordance with their deeds they are known, by their Names renewed, to be the Offspring of HhaALhhim with evidence. Herein do they appear with the Flesh of HhaALhhim composed of the values of  $2 \times 2 = 21$ .

## The Ten Circles/Spheres

The Ten Circles are States of the Lights of Chækúwmah and Bayinah, which are א:א, or 5:5. These two Lights, the Light of evening and the Light of morning comprise one day—one act. By these Lights we perform the Teuwrah according to the words of perfection through which the thoughts of HhaALhhim are spoken. From the Lights, depicted as the sun and the moon, both being circles of Light, come forth the values of O:O, whereby the Light is multiplied, and whereby all things are made from nothing. According to the O:O we speak into being the 10 states, which are depicted in the mishkan as 10 curtains. In that the curtains are of the fruit of Light, they are of Knowledge. As the curtains are hung upon the Zayin, they conform to the space amidst the boards. In like manner the Flesh of HhaALhhim is connected to the Bone, as the curtains are looped unto the boards. The spaces are filled with the Breath/Reúwach of our Names, whereby we are filled with the Breaths of HhaALhhim. The Number of these spaces is denoted above in the 96 spaces around and 96 spaces within the cube, all ratios in which thought transpires and abides. These numerical ratios are released from Dan and flow from the House of Nephethi, via the Name of Yatsaor. At the corner, they pass into Yahúdah, and are set into the body via the Name of Aúnun/Onan. The numbers are expanded by Aparityim which feeds from the side of Yahúdah. As Aparityim feeds upon the values, the Numbers multiply through the camps.

As one looks at the curtains Face to Face within the cube, the ten curtains are seen, being paired side to side. This is the arrangement of the curtains as the Mishkan is set up. When the Mishkan is transported, the curtains are folded upon themselves for transitions, and then unfolded and hung as the camp comes unto their next dwelling state. Likewise, we abide within the States of Unity as we camp and as we make transitions. All that we do and consider are within the State of our Curtains, for our thoughts and our deeds abide within the Rings as they are extended from the core of our Names or their branches. The curtains are in a paired configuration of Unity from day to day, as they abide in pairs being joined by the Neúwn “50” loops in whatever state they are being carried. As the curtains are suspended within the cube, they appear as two O:O from the top or from the bottom. From the sides they appear as 5 garments. According to the perspective of the curtains, we see them arranged as they are hung upon the poles or as they are folded for transition.

## The Ratios of Perfection

According to the ratios of Light, being side to side, and impartial in thought one to another, the Letters are perfectly joined one to another, whereby the words of perfection are spoken, and the works of perfection are performed. As we abide within the Words of ARAL, there is no corruption nor turning unto the shadows of our imagery/faces. Rather, we abide unto the Faces of AL and dwell in all of the Ages of the Directive Consciousness.

- 1:1** AL to AR, AR to AL, AR is the pair of AL; the Head to the Tail, a beginning to an end, one to one, equality, impartiality, total giving from side to side
- 2:2** Faces to Faces; expressions of eternal values that sustain one another, as a deed sustains a thought in which there is no leavening of distortion or corruption
- 3:3** Side to Side, a side of Wisdom to a side of Knowledge, a side of Wisdom to a side of Understanding; a side of Wisdom to a side of Wisdom; a side of Understanding to a side of Wisdom, a side of Understanding to a side of Knowledge, a side of Understanding to a side of Understanding, a side of Knowledge to the a side of Wisdom, a side of Knowledge to a side of Understanding; a side of Knowledge to a side of Knowledge, the sides of a house are equal to one another whereby they are in perfect balance upon the Foundation of HhaTsur
- 4:4** Gate to Gate; access points and transference within the order of the Light, as the moon enters into the gate of the sun, or into the gates of camps during a monthly rotation; the gates within orbit, the gates from one Ring unto another Ring, whereby they are aligned one another; the means of achieving stability, progress, and growth, as the values pertain to the Foundational State of HhaTsur/The Rock.
- 5:5** Eye to Eye; with the singleness of eye we behold all that is within the Union; being as Hhúwa Úwah Hhúwa/אָפּאָ;  $5:5 = 1$  as RAúwaben is to Yeúwd, being the Principle unto its full extension through which there is nothing hid; should we retain a spec of faultiness within our eyes we restrict what one can see
- 6:6** Mercy to Mercy, Serpent to Serpent; Mercy to Instruction; through mercy we obtain every instruction; as six parts of one are six parts unto another, the staff in their midst; evening to morning; six sides of the Menurahh to six sides of the Menurahh
- 7:7** Neck to Neck; to transpose from one age to another; from the midst of one Ring unto another where the 50/7 loops are joined to the central staff; shavbeth/shabbat to shavbeth; moon to moon
- 8:8** Top to Bottom, Lateral to Vertical movements; ALphæh to Chayit, the passage from one week unto another; from renewal unto renewal



**9:9** Drink to Drink; Chavarim/Friend to Chavarim; Joy to Joy; fruitfulness to freedom, whereby all things are of Liberty

**0:0** Mouth to Mouth; Nothingness to Nothingness, the state of a new creation, new age; being Breath to Breath, Spirit to Spirit

*The Letters of the Rock are the Source from which the 10 curtains of the mishkan are woven and from which all ratios of thought are formulated. The Letters of HhaTsur/The Rock are the multiples of Light, whereby they are 0:0:*

8 Letters x 4 quadrants = 32/9C/א. The 8 Letters are multiplied by the four quadrants in which they abide as the foundation of all Ages. From this discernment of Dan, the formulas of all things are combinations of the Letters and the spaces in which they reside.

As the Light as subject to the 0:0 x 5 they comprise 10 states, unified, having the reductive of 1. The 10 are formed by the 0:0 mouth to mouth state, whereby all things are made from nothing. In multiplying the value of 32 x 0:0, the value is 64 conveying the Unity of the Teraysarun paradigm, with a reductive of 10, of which are the ten curtains and from which come the ten lands. The Five to Five that are comprised of the Letters and the four quadrants comprise the foundation of Wisdom and the walls of Understanding through which one ascends into the Directive Consciousness of ARAL. The Unity of Shayin/21/Wisdom and Oyin/16/Understanding is 37/10. As the Lights of Bayinah and the Lights of Chækúwmah surround the Life within a Seed/Word, so the Seed flourishes whereby it is multiplied or doubled. Hence, the ratio of 0:0 is the ratio for multiplying all things of AL. From within the multiplication of values arises all ratios of thought that are perfect and complete.

The values of Shayin/W/Wisdom/21 + Oyin/O/Understanding/16 + Dagot/Δ/Knowledge/4 = Light/א/5. The Light/א compounded by 0:0 creates the 10 curtains in which we wrap ourselves in the garments of immortality.

A Pillar of Cloud by Day and a Pillar of Fire by Night

As the ALphæh rises to the Semek, it carries the Zayin with it, whereby the Zayin forms the parameters of our thoughts, even the entire spaces of Light are determined in the manner in which we speak the Principles of AL. In this manner, the Word of the Zayin/tongue fills the worlds in which it makes. Through the Zayin we are able to enter through the pillars of the Light in their unified states. These pillars are the pillar of cloud by day and the pillar of Fire by night. The pillar of Fire is the Shayin upon the Lammæd, the radiance of Fire coming out of the staff, which is the tenth power of the Lammæd. The pillar of cloud is the Hhúwa within the Neúwn, being the body of Understanding that rises with the mist. The pillar of Fire is the Rod, of which is the bone; the pillar of the cloud is the flesh, being the body of the Neúwn. In the cloud the Lights of the Hhúwa appear. The lights within the clouds pertain to movements, progressions and encampments of thoughts. According to the illumination imparted to us during the night, from the Staff of Understanding with Knowledge, we proceed in the day by the cloud of Understanding with Wisdom. Herein we travel with the Lights as we discern through Dan the

path in which we are transversing. The pillar of Fire by night creates the pillar of the cloud by day, even as during the night the pillar of mist is being formed for the subsequent day.

Through the tongue of the Zayin we are able to reach from one end to unto the other via which all things are accessed and aligned, even as our Words are able to align all parts within us. Through the tongue/Zayin, the Lamb is sacrificed and opened fully, and then extended from the base of the Hhakaiyúwer/laver unto the ARrúwnn/ark. Each step of the oylah is transversing upon the Ladder of Yaoquv, from the base unto the crown. Through the oylah, we commence with the activations (washings) of the hands and the feet at the base in the Hhúwa. We proceed to open all in the midst of the neck of the Neúwn, and then we rise to the Kepparat—the seat of mercy in the Quphah. Each step of the oylah service, through the Mishkan, is a transversion upon the Ladder of Yaoquv, being so called, for the Ladder comes from the Mind of AL and returns to the Mind of AL, where Yaoquv, the patriarch of Knowledge, is seated.

Through the tongue all things are made and all things are read to be understood. According to the level of our members, they abide within the Rings of Light or within the rings of darkness. When one takes the Word of HhaALhhim and deduces it to this realm, they become committed to that which is foreign unto themselves and take upon themselves the confinement of that which is dead, as though it is living. For when the Word of HhaALhhim is shortened, the form that is created is diminished in that the complete Word of HhaALhhim is not spoken. This is what is called death, as the form that is formed does not continue, but perishes, having within it aspects of partiality, for if the Word is not spoken as it is in the Mind of AL, then it falls short. The deeds that follow fall short also, whereby they are of sin, being not of the Seed of AL that lives and abides forever. The Word of HhaALhhim is living. The realm of mortality is death. Hence, to subject the Word to the mortal fabric binds one to mortality, for in so doing, one adheres to the Word at the level to which they have read, and seen, and heard, according to the level that has been spoken unto them.

As one understands so they bind their soul to the level of their comprehension. Hence, many have only buds upon their trees, but the full expression and fruit of the soul is yet within. The blood and the grace of their Names have not been appropriated to bring forth the full evidence of their Names to which they have been called in ALOZAR. In that one has eyes with lids still upon them, and ears with the skin wrapped over them, and a tongue that is not welded by the Fire, whereby their is an uncircumcision of speech, such is the evidence of the buds of soul that have yet to open within the Rings of HhaALhhim and be born from above. The faculties of soul have yet to open and bring forth the radiance of the Light to which they belong. All of the Houses of Light that are evident within a natural body belong to the spiritual body. In that the Houses are present demonstrates a proof that one has carried their soul with them from Hhashamyim into the shadows of mortality. The members of soul are protrusions upon the branches of the Tree, but until they flower and open, they have yet to bring forth the fruit of HhaALhhim with the Seed—the Word of HhaALhhim within it. **The fruit of the spiritual body is the expression of the Word apart from the mortal frame, whereby the spiritual body rises out of its former abode into a new body of residence.** The transference from the kingdom of darkness to the dominion of Light pertains to all levels of abiding, in words and in deeds, and hereby do we know those which have so been transferred in our midst. **The Seed of**

**AL rises through the natural body and forms unto itself a spiritual body that is not of this world, whereby the former passes away and is remembered no more.** Though we abide in unnatural bodies to the Rings of Light, the Works of the Light are self evident within our dwellings, for the deeds of the Teuwrah rise within us as leavening that is hidden within the corruption to give testimony of our Names in the world. Though we are in a foreign state to the Circles of Light, **we bear testimony of the consciousness of the Rings of Light in which are the sayings and the works of Light. Every saying and every deed is perfect within HhaALhhim for they are of the United Rings, spoken from the Unified Eye as Gad speaks from RAúwaben. The works of the Teuwrah, as they are set in motion, do not cease but continual ly bear the fruit of HhaALhhim.** However; the works of mortal flesh are self evident (beheld only by those in mortality), which are outbursts of anger, due to the leavening within their members that causes corruption, wherefore they bear deeds that are not in harmony with the Eyes of HhaALhhim. In that their eyes are yet blind, they do not see through or into the Eyes of HhaALhhim.

### The Ten Lands

The ten states projected by Chækúwmah in YæHúwaH unto Avrehhem contain the ten spaces of Thought from the Zayin to the Oyin—the entrance into the AynnSayuwph/אֵינְן־שָׂאוּ־פֶה, being limitless—without form—yet exceedingly broad according to the Seed Word being fully extended— which is on-going/eternal. **These ten states are the body of the Letters, being flanked by the six Letters to the right and the left, which form the wings of the serpent body.** The letters Zayin to the Semek form the body of the Union. The Neúwn and Semek comprise the neck of the serpent upon which the Oyin Head resides. The Letters are arranged in pairs, 5 to 5, as the curtains in the Mishkan [Sepher Yetsiat Metsryim/Exodus 26:1-3]. The neck arises from the Neúwn with the Semek. The Head of the Body is the Oyin. The Oyin is positioned amongst the Letters as the head/Rayish of the Bayit/body in the middle column of letters: Bayit, Tæyth, and Oyin.

### Processes Devoted to Ten Levels of Word Consciousness

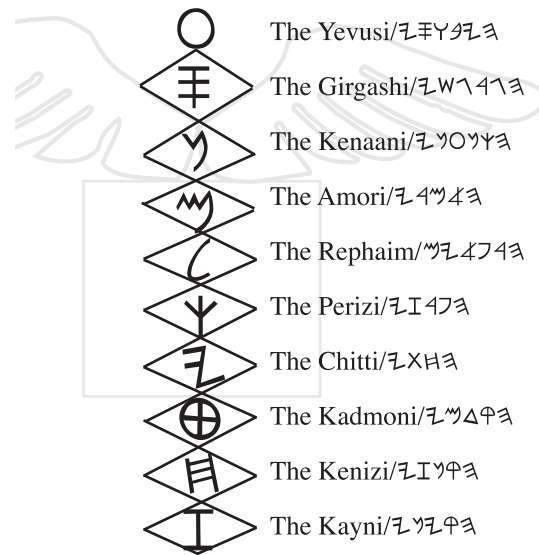

### The Covenant Cut with Chækúwmah and the ALders (Elders)

Unto Wisdom we dedicate these ten lands for their occupation for the Houses of YishARAL, being the offspring of the ALhhim. The lands are formed as they are hallowed out by Chækúwmah and Bayinah to be filled with the full radiance and glory of the Lights of the ALhhim. As we dedicate these lands to Chækúwmah, the eternal Principles, within Bayinah, are sowed into them through the Zayin that the lands may be filled with the Light of the Shayh. We hereby redeem these lands from the hands/activities of the foreigners who know not YæHúwaH and overthrow the inhabitants of these lands which are estranged from Avrehhem and all that is

outside of the covenant of YæHúwaH, which has corrupted the site of the Mishkan and the surrounding fields. In accordance with the Ancient Alders/Elders of AL, who are positioned within the longitudinal parallel lines of the grid work in these lands, we affirm the origins of these lands to be from the midst of ARAL and reserved for the full expression of the Lights through the offspring of the Counsel/Queen of Names—Bayinah. The Offspring are of the 70 Names of ARAL, born through the Virgin Counsel/Queen Bayinah. Unto these 70 Names the lands are given as an inheritance. Upon the 9th day of the month of Nephethli, we make the oylah sacrifice of Zebúwlan, whereby the blood flows as the rivers within these lands unto Chækúwmah. The blood is the means to transfer all properties within the lands unto Chækúwmah. According to the giving of the blood of Zebúwlan **we enter into the covenant with Chækúwmah** that these ten lands are the eternal property in the hands of the kuwáhnute/ priesthood for ALOZAR and are set apart for the Mishkan be built anew in Nephethli, around which all Houses of the ALhhim shall camp and walk in the Light coming from the Haikal/Temple of the Shayh.

**From these ten states of thought come the Ten Words/aka The Ten Commandments which is the framework of the Túwrah.** *When we add the twenty-two letters of the ALphæh Bayit group of Letters, from one to twenty-two, the value is 253 which has a reductive value of 10 and a further reductive value of 1. The value of 253 is the full extension of love/𐤅𐤁𐤌/8, being the Thoughts/200 of Love/8. Love is the bond in which all attributes are kept as One and via which Principles flourish. The Names of the ten lands are summed up in the Túwrah as the word Arets/𐤀𐤊𐤃—*the full expansion of Unity, established by the giving of the ALphæh, via which all Thoughts attain unto their full branching in liberty.* These lands are the core extension/Body of Unity—Understanding through which the Words of Wisdom are extended into the utterance of Túwrah Knowledge.*

1. The **Qayni/Kenite/𐤑𐤁𐤏𐤍𐤏𐤍**/State of Zayin/means to open and hold a thought via regulating speech according to the eyes, ears, word assembly to assist value determinations, abides in the lands of RAúwaben/eyes, Shamoúnn/ears, Gad/mouth, and for Yahúdah/liver/right thumb.
2. The **Qenizi/Kenaz/Kenizzite/𐤑𐤏𐤏𐤏𐤏𐤏**/State of Chayit/to investigate/to point/detect direction of a thought process, abides in the lands of the Yahúdah/kidneys/right index digit.
3. The **Qedmuni/Kadmonite/𐤑𐤏𐤏𐤏𐤏𐤏**/State of the Tæyth/to determine/affirm origin and acquire illumination through the gates to distinguish the category of thought/right middle finger.
4. The **Chiti/Hittite/𐤑𐤏𐤏𐤏𐤏𐤏**/State of Yeúwd/affirm, seal the perspective, verify or annul a thought or concept which is through labor/deeds affirmed through meditations/right fourth finger.
5. The **Parizi/Perizzite/𐤑𐤏𐤏𐤏𐤏𐤏**/State of Kephúw/right little finger.
6. The **Rephayim/𐤑𐤏𐤏𐤏𐤏𐤏**/State of Lammæd/left thumb.
7. The **Amuwri/Amorite/𐤑𐤏𐤏𐤏𐤏𐤏**/State of Mæyim/left index finger.
8. The **Kanaani/Canaanite/𐤑𐤏𐤏𐤏𐤏𐤏**/State of Neúwn/thought to be extended/branch/spread out via Breath functioning according to concepts and their expression/left middle finger..
9. The **Girgashi/Girgashite/ 𐤑𐤏𐤏𐤏𐤏𐤏**/State of Semek/thought to dwell in pairs and in clusters via illumination of the collective state of HaShem/left fourth finger.

10. The **Yavúwsi/Jebusite/ ַיְבֻסִי**/State of Oyin/ride upon the heights of the land, all enemies under your feet/Lammæd/left little finger.

Combined Thought Processes Related to States of Dwelling

*Throughout the Túwrahh, in accordance to our stages of progressions, various thought processes of strength are combined to achieve the State of Residence unto which we are progressing. The following are States of Residence via combined thought processes.*

Our initial State of coming up through Metsryim/Bodily Definitions/Forms is the collective state in which we are nurtured and come into agreements with the aspects of Breath, forsaking the residence of the body of flesh [Egypt/lower definitions] as habitation. We are given milk and dates as initial states; but let it be understood that this is not your final destination, for you are coming to a place of strength of Mastery within the Serpent Head of Oyin/O. In this first place, we receive a flowing of milk/grace to nurture us and lessons in agreement, but this is secondary to coming *to reside within a collective whereby we may expand our thoughts without bonds and enslavement to forms* [Sepher Yetsiat Metsryim/Exodus 3:8]. One who abides in flesh abides alone, divided from the whole; one who abides in Breaths are of the collective of Names amongst the joined strands of thought unto a liberty of expansion. Thus, emergence through the flesh and its waters of reflections leads to states in which we are nurtured unto expansive states of Seed.



The serpent joined from the base to the head conveys the Name of YahúWah.

**The Good/Collective and Broad/Expansive Land—  
A Land Flowing with Milk and Honey [Sepher Yetsiat Metsryim/Ex 3:8]**

- ַיְבֻסִי ַיְבֻסִי ַיְבֻסִי ַיְבֻסִי An United Order State—Good/Collective and Broad/Expansive
- ַיְבֻסִי ַיְבֻסִי ַיְבֻסִי ַיְבֻסִי An United Order State—Flowing with Milk and Honey
- ַיְבֻסִי ַיְבֻסִי ַיְבֻסִי ַיְבֻסִי An United Order State—To Stand, Be Established in a Place

**ALHaMaqom—Unto The Place of the combined Thought Processes of the:**

- The **Kenoni/Canaanite/ ַכְּנֻזִי**/to branch into all fields of Thought;
  - The **Chitti/Hittite/ ַחִטִּי**/to affirm and verify the attributes of the Inner Kingdom;
  - The **Amuwri/Amorite/ ַאֲמֻרִי**/to consider the Sayings of the language of this land;
  - The **Perizi/Perizzite/ ַפְּרִזִּי**/to expand with security in sequential steps, stone upon stone;
  - The **Chaúwi/Chivi/ ַחֻוִּי**/to unite the hands/extensions and maintain unity during development as a mother unites all parts as they are entering into new lands;
  - The **Yevusi/Jebusite/ ַיְבֻסִי**/to go beyond obstacles that will lead to subduing all adverse thoughts to this level of achievement.
- The above six processes of thought have arisen from the base of the serpent; namely,

The **Qayni/Kenite**/קני/קני/ to open all that holds a thought;

The **Kenaz/Qenizi/Kenizzite**/קניז/קניז/ to inquire in all associations of thoughts and discern direction of thoughts;

The **Qedmuni/Kadmonite**/קדמוני/קדמוני/ to discern the origin of thoughts and how they branch from the gates.

These six processes of thought include the Chaúwi/Chivi thought which is not one of the ten appointed for Avrehhem—to bless/expand the Principal Name—but which is present as a sixth power, to assemble and nurture the Names in their dwellings. The Chaúwi denote the presence of Chaúwah/Eve, the Mother of all living amongst our Names. The Chaúwi thought process is seen as necessary for perpetual motion and to bring up the Name unto succeeding levels. The Chaúwi assist us to bring forth the inward patterns of Unity that we descended with into the Earth as we formulate our new abiding States in Light.

---

### **Thoughts for a Name to have an Appearance— To come to abide within the Lands [Sepher Yetsiat Metsryim/Ex 13:5]**

בא כח איתנו יצאנו בך In accordance with our birthing in YishARAL, YæHúwaH causes us to have an appearance—to come within the United Order of the Lands

#### **A State of combined Thought Processes of the:**

The **Kenoni/Canaanite**/קניוני/קניוני/ to branch into all fields of Thought via submission to one another and the humility of pairing;

The **Chitti/Hittite**/כיתי/כיתי/ to affirm and verify the attributes of the Inner Kingdom whereby all Principles become arranged and positioned for expansion;

The **Amuwri/Amorite**/אמורי/אמורי/ to consider the Sayings of the language of each State of Residence whereby the thoughts are articulated and fully enhanced with words;

The **Chaúwi/Chivi**/כיווי/כיווי/ to maintain sequential progressions for each State of Residence;

The **Yevusi/Jebusite**/יבוסית/יבוסית/ to rise above obstacles before the Gates; subdue/overcome all adverse thoughts under our feet, and to encompass the territories entered.

The above five processes of thought pertain to our emergence into the States of the Oyin Body from the state of mortality. One may also combine these thoughts to enter into the womb of one's natural mother. As you have the Kenoni thought to branch, the Chitti thought to verify that which is within, the Amuwri thought to speak, the Chaúwi thought to progress coupled with the Yevusi thought to come to mastery, you are brought to arise from one state unto another. However, if other thoughts are present with these that are in opposition, you will not enter into the Oyin Body directly until there is a resolution of the opposing thoughts. For example, you have may the concept to branch your mind but not with the humility of being paired with another Name. Or you may have a concept to verify your gifts but for the sake of recognition from others. You may speak of worldly things instead of the glorious things within your collective Names. Or you may seek mastery in the kingdom of this world by bowing down to a lesser

form. However, the above five processes must be present and united within the Name's Mind to enter the States of the Oyin Residence. Via the agreement with these five thoughts and with the flowing words to nurture us, our collective faces appear within the United Order of Lights. We emerge from the veils of Metsryim and robe ourselves with the immortal garments of Light. The entrance into this level of progressions places us faces-to-faces with the Union, and those to whom they are joined, as thought strands in the House of YæHúwaH.

---

**Thoughts to encounter Amaleq to Dwell in the Mountain—  
in realms of Mind Illumination;  
And Thoughts to Dwell by the Sea with a Hand to Acquire  
Knowledge  
—the Yordan  
pertaining to the Composite Lights and their *Gatherings of  
Knowledge*  
[Chamesh haPekudim/Numbers 13:29]**

אֵלֶּיךָ שְׂוֵיֶיךָ The emanation of Breath abiding in the Mountain (Kal participle 3rd per sing)  
מִן־הַיָּם לִפְנֵי־הַר שְׂוֵיֶיךָ The emanation of Breath abiding according to the Sea/West—together with  
the streams coming from the Mountain/Illumination Thoughts

**The combined Thought Processes of Abiding in the Mountain/Illumination of  
Mind is comprised of three Thought Patterns:**

The **Chitti/Hittite/כִּי־אָמַרְתָּ**/to affirm and verify the attributes of the Inner Kingdom whereby all Principles become arranged and positioned for expansion;

The **Yevusi/Jebusite/כִּי־יָרַדְתָּ**/to rise above obstacles before the Gates; subdue/overcome all adverse thoughts under our feet, and to encompass the territories entered;

The **Amuwri/Amorite/כִּי־אָמַרְתָּ**/to consider the Sayings of the language of each State of Residence whereby the thoughts are articulated and fully enhanced with words.

**Thought Processes to abide pertaining to the Sea/Gathering of Knowledge and the Mastery  
of Knowledge are *the Hand of the Yordan***

The **Kenoni/Canaanite/כִּי־יָרַדְתָּ**/to branch into all fields of Thought, facilitated through humility and submission within the Collective Union of Lights. The Kenoni is the extension of the Garden of Eden that contains all branches of Knowledge. The term “Kenoni” refers to all of the trees of Knowledge in the garden and the means of accessing the Knowledge via humility and submission within the pairs of associated branches/trees. Until we are submitted to the pairs of branches, we are unable to correlate the thoughts from one branch unto another. Should we neglect a branch of thought, we disassociate our mind from processing the thoughts that the

branch is bearing. Via the Kenoni, we are submitted unto the totality of branches whereby one branch does not dominate or project itself above another branch. In this State of Thought, we acquire Knowledge from the vastness of the sea and become a Master of Knowledge by the Yordan. The Yordan River is *the area of the throat to the sea of Chinnereth—the heart*. **The river of the Yordan/יַרְדֵּן is where words arise from the heart to be projected by Breath. It is the critical area in which Words are processed to be uttered.** Thoughts, as they flow in the Yordan, pass through the land of Dan/lungs.

Concepts descend into the loins/testes and arise into the heart via the sacrifice, then arise unto the tongue/Table of the Faces/Shulchan Panayim unto the Ark/Mind; the Yordan conveys the full extent of the daily sacrifice. One who masters the regulation of Knowledge/יָדָע with discernment/Dan/דָּן controls the fiery wand of the tongue. One who regulates the flow of thoughts unto the Yordan is a Master of the wand/tongue, which is summed up in the phrase, the Hand/Mastery of the Yordan/יַד יָדָעַת הַיַּרְדֵּן לְדָן *al Yeúwd HaYordan*.

The above four processes of thought are distinguished to attain to the heights of Knowledge and its flow to the vastness of the sea. We attain illumination *via three primary thoughts in combination* to ascend the mountain where the Light strikes the Head. The Principle of three corresponds to the third letter, Gammal/ג, whereby the illumination seated within our loins arises unto the Head—mountain top. The three categories of thought for illumination are the Chitti, the Yevusi, and the Amuwri. They to be read as one, for the verb tense is singular, though we have a plural compound subject. The verb form, שָׁכַח, has been called the Kal participle, 3rd person singular, commonly rendered as “he is dwelling.” The word arrangement conveys that the three dwell collectively. The verb is best rendered *as an emanation—a Breath projection into a dwelling State of Illumination, whereby we are carried and lifted unto the heights of the mountain*. Through our projections of Name—the exhaling action of Breath, we are positioned to be moved, in this case, elevated by the power of the Wind/Reúwach/Spirit. Whereas in our inhaling action, we are positioned to carry the thoughts inwardly. The sum value of the three thoughts: the Chitti/כִּי/45, the Yevusi/יְבֻסִי/48, and the Amuwri/אֲמוּרִי/49 total to 142/7, the same reductive value as the one word—mountain/רֶם/25/7. This is *a classic example that the verb forms* in the Túwrahh and ancient Hebrew pertain to actions of the Fiery Breath and not to physical gender and number designations as imposed upon them.

Via **the Chitti/כִּי**, we affirm the revelations of the Mind within the body. Unified thoughts belong together by association. The association of thoughts is displayed in the networking of Names within the collective dwelling of the body. In the collective gathering of thoughts in the Aures/Land, as well as in lower manifested residences, we witness the ordering of thoughts as they are arranged in our body parts, via which we affirm a greater collective of Names. The affirmation of the Chitti applies to all expressions of mind both of thought and in form. We do not need a physical body to express the Intellect of Breath. The garments of the Breath include righteousness, humility, love, joy, peace, stability...which are threads of thoughts drawn out of Breath in which Breath resides.



We maintain leadership of the Heads over the body and all expressions with **the Yevusi/יְבֻסִי** Thought whereby illumination in which we are arising prevails over all previous states of enlightenment. The hours of the Light that we assembled yesterday will be affected by the light of today which will take us further up the mountain. Via the Yevusi thought we consider our enemies our friends lest we entangle ourselves with lower/outside forms in outer darkness. What may appear as an enemy may distract the Mind to war with the flesh and its subtleties that call us into the natural world. Via the Yevusi we prevail over Amaleq who resides in the south. As to Amaleq, we must consider that in every level of progression or in each generation/level of suspension and achievement of inner birthings, there will be war. As the Túwrahh states: “As a consequence, the Hand above affirms the base/foundation of Yah: For YæHúwaH wars/joins forces/combats with Amaleq from generation/a gate of Knowledge to generation/a gate of Knowledge.” [ref. Sepher Yetsiat Metsryim/Ex 17:16]. The Name of Amaleq pertains to resistance and obstacles before the gates of Knowledge. From every birth—break through to each succeeding level of Knowing, we encounter Amaleq.

Why does the thought of Amaleq reside/dwell in the south where the dominion of the sun spreads out? We may associate Amaleq with birth, where there is resistance, labor, and a tra-  
vailing before the head is crowned and comes forth with full revelation. At birth, the outer veils of the mother no longer hide the mind within. Thus it is said that the resistance/Amaleq is in the south—unto full disclosure. *The resistance is to protect the inward and to guard the revelation until the time of ripening.* To pass through the Gates of Knowledge we must be united—a collective force of YæHúwaH, with the joined hands of Aharúwan, Hur and maShayh, whereby we prevail over obstacles before the gates. With the unity of enlightenment, nobility of values, and the core Light of the Lamb, obstacles are subdued under our feet. The Yevusi thought enables us to enter through the gates and proceed unto our next stage of progression.

The Yevusi leadership is supported by **the Amuwri/אֲמוּרִי** thoughts which provide the Sayings of Illumination. With devotion to Words and their description, we abide in the Illumination, for the Light is carried within the frequencies of the Words, and in Word Constructs we reside. When the scriptures speak of abiding in Meshiæch/Messiah, we understand that it is referring to Word Constructs of Light and not to an individual. The Collective Word/Meshiæch is a composite of all sayings composed of the thoughts of YæHúwaH. To say that the Word became flesh means that the Word clothed itself according to the Thoughts of YæHúwaH *and became evident. The garments were not of mortal flesh, but rather of the Thoughts of YæHúwaH that reveal the full measurement, being a full revelation and a complete statement of The Collective Name.* We are admonished to clothe ourselves with humility toward one another; for in so doing, we take the leaves of the Trees of Knowledge, from the Kenoni/Seed State, and fashion a garment that depicts the complete Word of YæHúwaH [I Kayphah/Peter 5:5]. We arise from Wisdom supported by Understanding, and via Knowledge ***we are clothed as we draw out all traits of Wisdom unto Knowledge.*** Knowledge is the spinning of the threads of Wisdom. Thus, every plant is like a spinning wheel that draws out the traits from its foundation, via the spinning wheels of light cycles, and brings them forth to make the nests of birds and the clothes of Light. The plant spins, as one seated at the spinning wheel. From its seed foundation/seat, it spins the fiber as a spider. **The spinning process conveys that from the Concepts/Principles that we carry in our baggage/House of Maneshayh, so are**

**the expressions and garments that we weave.** Some of our garments must be rent for they were woven from corruptible seed and born upon the thoughts of being two-sided/faced. Every House/Member of Name is woven a garment drawn out from their Concept Base of Light.

Coupled with the Illumination, we reside unto gathering the thoughts into the West or the Sea—via **the Kenoni/קֵנוֹנִי** thought—a location to spread out the thoughts whereby they incorporate all messages being conducted into the bodies of water and become revealed within the immortal fabric/expressions of our Name. Having come to the mountain, we also abide in that which pertains to the Sea/West, whereby we gather the stream of illuminated thoughts into a body of vastness and expression. The Sea is the depository of the Mountain. As the rivers begin in the Head, they proceed unto the Sea, and hence; a saying of the Amuwri arises: *“Those who dwell in the Mountain keep watch over all who dwell by the Sea.”* For one of the enlightenment watches over the bodies of waters within them to be in accordance with the illumination of the Mind. Otherwise, one may have a fleeting thought, but the results are not forthcoming, since the thoughts lack substance—as a cloud without water. **The Mind that is enlightened carries forth the Light unto the masses whereby all Names may behold the Light from the mountain.**

---

## **Thoughts to Multiply the Faces of YæHúwaH within a Collective Name.**

**The coming into the Land Affirms the Direction of Your Name.**

**Thought Groupings to Multiply and Regulate Expressions.**

**Processes to affirm and establish the Residence of YæHúwaH via Breath.**

[Mishneh Túwrah/Deuteronomy 7:1]

“YæHúwaH of your ALhhim brings you into the land” for there is no other Name/position except Unity that enables your collectivity of thought to come or arrive at the blessed state of the Aurets—the place reserved for the expansion of your Name. As you are humble in heart, so shall you inherit the land, for the land does not give its strength for arrogance nor can the proud enter into through the gates of Wisdom and Understanding. It is easier for a camel to pass through the needle than a rich man to enter into the Kingdom/dominion of Unity. For what is of this world will puff-up one, whereby they consider their importance in flesh. As we give all, whereby we hold not onto the world nor the things in the world, we are prepared in Mind to transcend the boundaries of the mortal.

Leadings day by day and night by night are guiding your Name into activities of Light. One walks according to the layering of thoughts of the night pertaining to the activities of the day. The night affirms the day as Bayinah affirms Chækúwmah. As your Name is brought into the

land through assembling the thoughts of Light, **the way is affirmed that your Name is to proceed in the light to manage/regulate every thought pertaining to your Name.** The power to manage or regulate the thoughts of your Name includes seizing all thoughts that do not pertain to your Name, although thoughts outside your Name are of little consequence as you focus on the thoughts of your Name. If your fields have yet to be designated unto your Name, then they are left open for other seed to flourish there. But upon sowing your lands with the Principles of ALhhim and keeping the fields cultivated, there is no space that is designated for other thoughts to reside. A space forms by a projection of thought; thus every space is created to occupy a thought, and when Seed enters therein, the space is consecrated to the Seed.

Only thoughts that pertain to your Names will dwell *in the earth appointed for your Names*. A rabbit cannot live in a bird's nest in a tree nor can any thoughts dwell in the Aures appointed for your Names except those thoughts for which the Earth/Aures forms. When YæHúwaH reads your Name, your Name is called. When your Name begins to breathe, having become awakened within you, your first breath is the Voice of Wisdom. **Via the Sayings of Wisdom all words began to formulate the ten Lands of Understanding, for Wisdom being of Bayinah, could formulate none less nor more.** The Ten Lands formed are for your paired thoughts to multiply within that pertain to your United Names. As you continue to breathe the thoughts of your Names, the space expands/increases and becomes filled with the attributes of Thoughts emanating from your Names of Light. As all is breathed that pertains to your Names, your branch of thought is complete and joined in pairs, readied to be woven into the fabric of YæHúwaH House. We even enter into the Oyin Consciousness by our Names, for our Names are the means of access into the chambers of Wisdom, and of Knowledge and into the gates of Understanding. The matrix and the frequency of the thoughts pertaining to our Names, as well as their dimension, fit upon the warp to create the woof of your Paired Names. Lower thoughts that are antithetical nor of the pattern of your Names cannot ascend into the spaces created and reserved for the thoughts of your Names. The plural of Names is used throughout for no one is to perceive their Name apart from another Name.

We create and expand spaces for our Names as Breaths inhale and exhale thoughts in Seed. Focus on the Words that comprise your Names to draw out attributes of your Names, for these concepts alone are in Seed that fills your lands with joy and abundance. The Earth—habitations of Light in our Names are Invisible for they are spaces hollowed out of by our Breaths. The House that we build for the Name of YæHúwaH is created by nothing, even as YæHúwaH, blessed be the Name, formulates all Names with nothing, for the worlds of YæHúwaH are by Words alone. When maShayh calls for us to bring the gold, the silver, the bronze, the skins and the purple, the red, the blue, etc. the Lamb is not ordering us to bring material wealth nor the coins of Egypt to make the mishkan/tabernacle. YæHúwaH House is built by the Names and their attributes of Knowledge that come forth from the mouths of YæHúwaH. Thus the House of YæHúwaH is the House of Names and the structure is comprised of the Thoughts of Wisdom/gold, Understanding/silver, and Knowledge/bronze and their fruit/expressions. There is no material offering that we can bring to build the Temple for all that is of this world will perish, but the House of YæHúwaH that we build is for a Name that endures all generations, a Name ageless, eternal, and only the materials that are of the frequencies of the Name of YæHúwaH be incorporated into the House of YæHúwaH. The gold and silver that we take out



Coupled with the multipliers are **the binders—the Getsumim**. The binders within you are the eyes for your seeing is to be single; the mouths for they are devoted to the Unity of your Name, the stomach with affirms your direction and amplification, the lungs which evaluates all thoughts, the intestines which determine the flow of ideas, and the heart which is the throne of your kingdom. According to *the binders* so are there six tribes to pronounce curses, better rendered, *to regulate your development*. **According to the members within you to bless and to regulate, there are given seven complete thoughts to process the multiplies and the regulators.**

These seven nations/processes are:

1. The **Chitti/Hittite/כִּיִּי**/Land of Yeúwd/to affirm, to seal a perspective, verify or annul a thought or concept which is through labor/deeds affirmed through meditations, to affirm the attributes of the Inner Kingdom whereby all Principles become arranged and positioned for expansion.

2. The **Girgashi/Girgashite/גִּרְגָּשִׁי**/State of Semek/thought to dwell in pairs and in clusters via illumination of the collective state of HaShem; the occupancy in groups—collective settlements. The single mind that dwells unto itself has yet to behold the Girgashi process and thus unable to make the transition into the collective.

3. The **Amuwri/Amorite/אֲמוּרִי**/State of Mæyim/left index finger, to consider the Sayings of the language of each State of Residence whereby the thoughts are articulated and fully enhanced with words.

4. The **Kenoni/Canaanite/כְּנִעִי**/State of Neúwn/thought to be extended/to branch into all fields of Thought via submission to one another and the humility of pairing.

5. The **Perizi/Perizzite/פְּרִזִּי**/State of Kephúw/right little finger, the process to defend, to be secure, to govern all that has branched forth with the scepters of Chækúwmah and Bayinah; via the Perizi we facilitate expansion via quests to know and regulate, to ask and then appropriate the wisdom and insights into our dwellings. One who continues to seek and then finds, without appropriations has yet for the Perizi to appear within their expressions and mannerisms.

6. The **Chaúwi/Chivi/כִּיִּי**/the bond of Unity that is amongst the nations, to maintain sequential progressions for each State of Residence.

7. The **Yevusi/Jebusite/יְבוּסִי**/State of Oyin/left little finger, to rise above obstacles before the Gates; subdue/overcome all adverse thoughts under our feet, and to encompass the territories entered.

There are three actions to take with the seven:

1. **We are to smite them.** This action is from the root nachah/נָחַח meaning that we are to arouse them, cause ripples to break out from them whereby they are serving our Name with a flow of thought processes. We are to regulate our thoughts so that they are serving the expansion and binding

of our Names into the House of YæHúwaH. As we prune a vine, so are the nations to be pruned and chastised to bring forth more expressions of Light within our branches.

2. *We are to consecrate* /מִכַּלְלֵם every process of these ten states unto the revelation and extension of a Name. This action has been mistranslated “to destroy,” and if we did destroy them, we would not have the great benefit of these processes nor the inheritance of possessing these processes for the full operations of our Names in Light. It is absurd that we are to destroy the inheritance that YæHúwaH gives unto Avrehhem and those of the Covenant.

3. *We are to retain our position of Name.* Therefore we are not to intermarry with these nations, for we are not to subject the Name unto the process of extension whereby the Name becomes mixed/bonded to the process. To join the Name with a nation is the captivity of Assyria. To become joined to the process is to seal up the openings/nodes through which we are to branch into full bloom. Should we make a covenant with them, we restrict our Name to a process and therefore reduce the frequencies of our Names activities. Rather we are to maintain the Unity to YæHúwaH unto which we belong . We are to appropriate the grace and favor upon our Heads to facilitate the attainment of Knowledge and not to place the fat portions of grace upon the processes that serve us. Each process operates at various levels, thus should we unite our offspring with them we would commit our level of residence at a fixed level of dwelling. We know no limits to which our Name shall rise to into the Kingdom of United Names. We belong to the collective of Names, and we are cautioned not to place restrictions or ceilings over our head that limit our expansion and activities in Light. May the One of ALhhim so move us forward into our dwellings of Light.

---

## Consecrating Thought Processes unto Revelations. Using Thought Processes in which we Dwell to Attain Knowledge and Verify the Order of YishARAL.

[Mishneh Túwrahh/Deuteronomy 20:17]

“For the consecration, you—your sum [collectively speaking to the assembly of all inward Names] is to consecrate /מִכַּלְלֵם: The **Chitti**/Hittite/כִּיִּי, The **Amuwri**/Amorite/אֲמֹרִי, The **Kenoni**/Canaanite/כְּנֹעִי; The **Perizi**/Perizzite/פְּרִזִּי; The **Chaúwi**/Chivi/כִּיִּי; and The **Yevusi**/Jebusite/יְבוּסִי. All processes of thought are to be devoted unto YishARAL, unto the upright ordering of the thoughts of YæHúwaH whereby YishARAL shall ride upon the heights of the Earth and over all Nations which are formulated on behalf of the Numbers of YishARAL [Mishneh Túwrahh/Deut 28:1]. For our thought processes as well as our thoughts can weaken our inner assembly and divert the order of our collectiveness, even to distinguish us as unto separateness. The strength of the processes is for the upright order and for the arrangement of Names within us.

Six names are processes of thought to maintain unity within our members. First amongst the list is **the Chitti**, a region of the heart. The Chitti is the process within the heart to gather, secure, prove, attest, and confirm. What we confirm within our heart and meditate upon are

devoted to YishARAL—unto the upright status of our United Order. Avrehhem obtained the lands of the Chitti as a means to understand and preserve a path for the transitions of Names. He did not destroy the Chitti, rather **the lands are obtained to secure a State for Names and their expansion**. We are to look at each level of residence as a land in which the concepts of our Names may flourish unto expanding the Name of YæHúwaH into every realm of thought.

In conjunction with the heart is the process of speaking—the **Amuwri**. The tongue and all processes used to utter thoughts are devoted *to speak of our collective order*. What is more important to speak about than our Inner Order of Names to which all is given and appointed? As we speak we project the consciousness of what is within the regions of the Chitti—that which we have gathered and become bonded with to dwell. What we take it into our hearts is accepted to be integrated into our habitations. How does our use of words affect the ordering of YishARAL? As we **speak only of the order of our tribes** we walk in the might of the inner unions. More so, as we speak of the order of our tribes, we speak of the complete Mind of YæHúwaH. When a person speaks of the errors of others, they indicate that they have accepted the errors of another and are carrying in their heart and in their forehead the mistakes, the lies, and the confusion of others. We shift from focusing on mistakes or faults, all which are illusions and perishing, unto an order unto which are Names belong—the **actual reality wherein progressions take place**. Changes occur by inner organizations. Whatever is spoken from within leads to its unfoldment. When we speak of the perfect, we then unfold the complete revelation within us. As we speak, we are bringing that which is inward to be placed into the earth of our paired Names for expansion and blessing. In speaking of our collective order, we create out of nothing the House of YæHúwaH by inward arrangements—which is the **Actual State** of Names.

Having devoted the heart and the communications, we then devote the **Kenoni**/Canaanite/𐤊𐤍𐤏𐤍𐤏𐤍 unto the full branching of our Names in Light. The full branching process includes the paths into the Mind of YæHúwaH and into all avenues of Knowledge where the details of YæHúwaH are stored and laid-up like mines of gold, silver and bronze. As we consider the branching within the Mind of YæHúwaH, we look at the extended base of the Tree of Lives and denote the twelve classifications of thought present that arise from the base. Out from your loins, the foundational seat of your Name, arises twelve branches. These twelve become fully extended and are the classifications of the extended mind, also known as the Hand of YæHúwaH. For when one stretches forth their hand, they have extended their mind as a composite of all that is inward. If you stretch your hand to heal or to bless, you do so with the complete order of YishARAL/Israel. Thus when YæHúwaH speaks to maShayh to stretch forth that which is within his hand, a serpent is projected. The serpent is the upright state of YishARAL on a pole which is the Name of YæHúwaH as “the Hand/Full Extension of Oyin”. [see chart: The Serpent is the Name of YæHúwaH; ref BHM Túwrahh Dictionary entry: YæHúwaH.]

As the serpent is joined from the base to crown, there are two sets of Hhúwa/𐤏 joined/𐤏 that comprise the value of the Yeúwd/𐤏, a formula of YæHúwaH/𐤏𐤏𐤏𐤏. This is an ancient formula of two Names that carry the Oyin Body as the 𐤏𐤏 configuration.

The Name of YæHúwaH is the Union/𐤏 the two mountains of Light—of Chækúwmah/Wisdom/𐤏 and Bayinah/Understanding/𐤏, being fully extended/𐤏 unto Knowledge. Though the

Yeúwd is written first in the Name, it is the last to appear. But in that the Yeúwd is an extension of all that is within itself, even as the hands are an extension of all within our houses, the Yeúwd will come to front of the Name as *the Doer of the Lights* and be honored to serve the Head as the wine server in the palace, for the Yeúwd is the servant of all. In like manner your hands will be blessed and carry the fruit of your houses as they are clean and engaged in the works of the Lights. Thus the first branch that came forth from the House of YæHúwaH was comprised of the value of 40, being of the House of Aharúwan/יאהא/ 40 [ $1+3+4=26$  (the Name of YæHúwaH/26) + the unfoldment of the Name/י = 40 ], via which all Names would be blessed by the United Hands of YæHúwaH, Yeúwd/אחל + Yeúwd/אחל = 40. From the United Name of YæHúwaH come all statements of Wisdom and Understanding and Knowledge. Though nations speak in the name of their alhim/gods, we will not deny the honor to speak only in the Name of YæHúwaH to whom we belong worlds without end. The Name of YæHúwaH is two strands of thought that give birth to Knowledge. When any two Names are joined in the House of YæHúwaH, they will be given access to all in the Mind of YæHúwaH and come to know all things. The two strands of Light are the primordial twisted/intertwined cords according to which all Names come forth and are sent forth in pairs. *In their Union, they move in the authority of the Perizi Thought.*

As strands of Light are folded upon themselves they yield five key words: IO = strength; אפ = to say/utter; אג = to spread out; אח = to investigate all there is; אצ = for your collective branching. In these five letter combination we have the words to bring forth all that is within our Names.

The five strands also formulate the activities within the House of Lights. These five activities are known as the five offering types, each pertaining to the Union within the Oyin Body.

Within every hand are two arched lines conveying two mountains of Wisdom and Understanding. The Mountain of Wisdom is the throne of the Queen of the South and is in the right hand. The Mountain of Understanding is the throne of the Queen of the North and is in the left hand. The arched lines run from the middle of the wrists unto the middle of the side of the hand on the thumb side. From the mountains flow four rivers. The River of Zebúwlan runs beneath the right hand index, and the River of Gad flows out of the top of the mountain on the right hand. The River of Beniyman flows from the left index finger, and the River of Nephethi from the top of the mountain of Bayinah on the left hand. As you lay your palms together face to face, your rivers will unite as two strands joining east and west and north and south. The two mountains will join and form the Mountain of YæHúwaH. Out the mountains arise two trees, one for each side of the Tree. Your four rivers are comprised of four heads with four bodies of thought, being the land in which the rivers flow. The staff of the tongue in the hand of maShayh/Moses is not a stick from a tree, but the Tree of Knowledge, both sides written within each palm. The twenty-four elders are depicted upon the backside of each hand, arranged in three rows of the nuckles and joints on each set of four fingers. The thumbs are two golden angels which form the Teraysarun via which a priest speaks the blessing. The Tree of Lives is the Menurahh within, the Seven Fold Lights in your Seed. As you slide your fingers into each other (palms up) and the mountains to the right and the left, you form the Oyin Body with ten sets of Taúwah—a twisted body of joined serpents.



The phrase, “*The Day is at Hand*” conveys that the activities of Light are resident now within our twelve members, and this day has been already extended from the Mind of YæHúwaH. We are not waiting upon a sign externally, nor upon a leader to arise from amongst us, nor for another prophet to declare the way, even though that which has been done will appear again for all things are in the Oyin Cycles of Thought and hence are forever to be encountered. We are not waiting upon a Messiah, thus Yahushúo said, you do not need to wait upon me for the Day is at Hand. We can act and achieve the status of living in the Kingdom or in the Dominion of Lights now, *for the Hand of YæHúwaH has already been extended as each of our Names have been sent forth with the activities of Light within us*. We were never sent forth empty-handed, for in our hands reveal the thoughts of our inner assembly. As we devote the Kenoni, we are setting apart the means to break all things down to be assimilated and fully known, as the Kenoni pertain to the lands of the stomach. We are also dedicating our gifts to elevate the branches of our Name upon the pole or the esophagus that pertains to the lands of the Kenoni.

As to the Kenoni, they are the paramount branches of thought that correspond to the eight Tsade arising within the cube of Wisdom. The eight Tsade are the Branches of Knowledge, the Living Flow of the Rivers of the Unified Mind. The eight branches are according to the Name of YæHúwaH/26/8, the Word of Love/Ahhav/8, the Túwrahh/53/8 and correspond to the eight letters Semek to Taúwah. There are three primary branches that arise from the Kephúw/Υ. On these branches are the paths of Knowledge regarding the Orot/Veils/Skins (woven patterns of Thoughts), the Chuqot/Statutes pertaining to the offerings, and the Mitswot pertaining to the commandments, the bonds between members, and how the members are arranged in pairs and Names of Light. In the midst of the branches, arising in the centre are two Tsade, pertaining to the 70 Names of Transformation and the Mishpatim, the Judgments or the results of the organization of Names. To the right, arising within the pyramid of Wisdom, which is also called the Right Hand of YæHúwaH, are the branches of Knowledge pertaining to the Processes of Thoughts, the Mishmereth/the Charge (duties of the gates/corners) and the Unified Sayings of the ALders (the aldermen). The strands of Wisdom, on the right and the strands of Understanding, on the left, depict the two serpents that unite and intertwine upon the pole of Knowledge. (See Chart above of the Branches of Knowledge.)

The exercise of the Tenth Power convey that the Paths of Knowledge are that which extends/elevates/8/Chayit, that which full communicates/80/Paúwah, and that which brings forth the combined stands of Knowledge/800/Taúwah via which we have access into the diamond paths of Knowledge.

Following, we devote the **Perizi**/Perizzite/רִיזִי as the thought process to defend, to be secure, and to govern all that has branched forth with the scepters of Chækúwmah and Bayinah. For what is extended out of the Hand will be defended by the surrounding powers of Bayinah, in that She who dwells inwardly will surround us as the Hen surrounds her chicks. As we identify with YishARAL and the two-thirds of the House of YæHúwaH that never went astray, we are surrounded by the Might of Bayinah. What are the two-thirds that remained with YæHúwaH? Those of the Houses of Wisdom and Understanding. But those of Knowledge, became the branches that broke off from the root and were carried away by the winds of false doctrines. And as we consider that all of Wisdom, Understanding, and Knowledge belong to

YæHúwaH, we may comprehend the great love that YæHúwaH has for YishARAL/Israel for *love is the active consciousness of belonging to one another*. YahuWah will patiently redeem her for the wholeness and integrity of the Unified Name to which they belong. As a Name cannot deny his own Seed its right to flourish, so YahuWah does not deny Offspring of YishARAL the path to return unto the seats of Knowledge and the Lands of the Oyin to which they belong.

When any of the lands of Knowledge affirm their roots, Bayinah will preserve the fruit that will arise from the lands and secure your Name within the tabernacle of YæHúwaH. For the strange and the worthless will not be gathered by the Hen, for they are not born out of the egg of Oyin. Rather, the wicked are like rodents that are born without hair and like worms that creep and roam the earth without a house to which they belong. The rodents and worms make no home but want to enter into yours for a dwelling. They like to invade the spaces of others, to enter into the poultry houses or the Hen's house for their dwellings from which they are to be evicted. As the House of the MacabbYahu drove out the Greeks with Antiochus Epiphanes from the Temple of YæHúwaH, even so we must drive out of our dwellings all that is estranged from the Order of YishARAL. Via the Perizi we facilitate expansion and the expressions (fruitfulness upon our branches). Via quests to know and regulate, we ask and then appropriate the Wisdom and insights into our dwellings.

Following the Perizi, are the **Chaúwi**/Chivi/כַּיִוִּי. Via the Chaúwi we sequential progressions within every level of Knowledge and enable the collective State of YishARAL to obtain the full Mind of YæHúwaH. The Chaúwi thought keeps us in perpetual motion and arising through the levels of the Oyin Consciousness.

Joined with Chaúwi are the **Yevusi**/Jebusite/יְבוּסִי, being the Crown upon the Heads of YishARAL for they have come to mastery, able to rise above obstacles, subdue and overcome all adverse thoughts, putting all things under our feet, and to encompass the territories entered.

## Cognizant Breath

Words that we speak and sing are of the level of our Intellect/Breaths. Cognizant Breaths desire to speak the words of the Túwrahh—those of Lives. The Judge of known Breaths hates for any member to violate itself for what is vain. The Judge of Dan realizes that the flesh accomplishes nothing apart from the directions of the Rúæch. Hence, the breath within, seeks to enlighten all parts in order that the members be sanctified to the abiding Breaths of One Body.

How is it that our Breaths carry the Words of Lives, laughter, music, and the world of thoughts? Breaths are configured with all attributes of Wisdom, Understanding, and Knowledge and thereby can speak at any level as it develops their houses of the teraysarunsim within their chambers. All of the body belongs to unified Breaths. The Breaths keep the body as long as they desire before letting it go to enter another state of residence. The body is precious to the Breaths for it serves as its houses; however, the Breaths made a great sacrifice to come into these veils, for it formerly resided amongst the Union of the Lights, amongst the glories of

ALhhim, prior to accepting garments of mortality. But as your Breaths of Names come to know the full values within these garments, the Breaths will be full and satisfied and seek to return unto the Place of Birth in Fire, from whence they are sent.

When tongues of Breaths depart from these veils they sting the body like a snake bites its prey, and with the sting, the body falls. This is known as the sting of death. The body will try to hang on to the Breaths, but when the Breaths are readied for departure, they sting its prey with a deadly poison. As Breaths depart, they go out like a snake, slithering away from the companion and den that housed them. This is necessary for the Breaths to advance unto new quarters. They must be released from a former to enter into the state that they have been building with expanding Thought and Word Constructs. Our next abode is the quarters that Breaths prepare through expanse of mind and via their alignment of Perfect Associations with all Names of the Union—those in the heavens and those in the earth. If you maintain separateness and singleness of identity, you will remain in a habitation that confers separate identities for you have yet to enter into the collective wholeness of Breaths and Invisible Thoughts. Separate identities, gender issues, and dwellings of mortality must be resolved in preparation to confer your Names into the Union of Lights. However, the blessings of a unified habitation await those who pass beyond gender identity and solitary occupancy. As we dwell in Egypt under the masters of forms, we reside in “strange flesh,” for we do not comprehend the order of parts nor the meanings that are held within each part of the body according to the Union. The body is yet “strange” to us because we do not yet know it. The dwellings of “known flesh” is a confirmation of the Heads that **the body of Light is a thought manifestation wherein all parts are recognized to belong to the whole and designated by Breaths for the expression of their names and numbers.**

### Dan interfaces with Breath & Mind of Seeing

The Breath carries all of the holy items of the Mishkan/Tabernacle, and hence functions directly with the House of Qahhath (Kohath), via which the messages of the kohen/priest are carried to all members through the electrical impulses/nervous network. The Mind of Aharúwan and Qahhath are continually leading the progressions of the House of YishARAL in every generation—state of suspension. Dan uses the information transmitted by the Breath and the nerves to make evaluations and judgments. The role of Dan is to provide discernment to all members to proceed with the guidance of the Breath and Mind. **Discernment of direction** is given daily. As the saying goes, “Let your nose be your guide,” for by its placement in the head, and being projected forward more than another part of the body, it is discerning direction. The decisions made by Dan are for the soundness of the house. Dan alerts the Breath and the Mind of any lurking dangers and provides assurance to the Breath and Mind to enter into rest. Dan will also indicate the nearness of a path or avenue to explore as a means of finding or discovering aspects/states of Unity. As Dan senses an access, the Breath will breathe quicker, with an excitement and anticipation, and the Mind will be ready to open the way for all of the inner tribes to make progressions.

## Shucham—Judgment according to the Equality of All Names

Dan, the judge within our household, seeks alignments, corrections, answers, and sentences. Dan explores all realms for facts of Knowledge and seeks Understanding and Wisdom that Shucham—the unified extension/offspring of Dan—may judge as one wise. Wise judgements are founded upon the Unity of HaShem without bias, preferences or distortions. As Dan seeks, so the Reúwach leads the judge into paths to find what is sought after. **The basis of receiving guidance is to maintain equality of all names** as the Name Shucham pertains. In equality there is an order by position and by emanation. Without an Order all would be chaos/disorganized. The Order of our tribal members is HaShem, the alignment of parts being vital for progressions. Equality states that all names are of One Breath, for it is the same Breath in all. Thus it is appropriate that we nod our head to each other in recognition of our Unity via Breath. Together we comprise One Reúwach. The parts or members are different according to their thought, and hence they are subject to each other. All are subject to the One from whence they have come, even the Priest or Enlightened Mind, who births them and carries them through every progression and transformation.

Dan detects appropriate unions for Breath to become intertwined for study and conversation, as well as intimacy with compatible intelligences. As Dan discerns all levels of interactions, so he serves the House of Laúwi and brings all tithes of the north into the camp of Merari, which stabilizes the house and enables further progressions. Via intimate relationships, both sides of Breath receive orgasm, which is the means for Breath to enter into all cells and to be expanded. Both sides of Breath are served—the side which Inspires/Enlivens/inhales as well as the side that Imparts/Confers/exhales. Dan, as a builder of Bet HaShem, detects compatible levels of intercourse, based on Words and Numbers [Sepher Yetsiat Metsryim/Exodus 31:6]. Dan also determines and selects all thoughts that are useful for the Mishkan and how they are to be performed. Through the intertwining/weaving together of Names and Thoughts, the Bet HaShem is built whereby the Breath/Reúwach of YæHúwaH is united into a collective Breath assembly under the Enlightenment of Mind. The Union of our Named Breaths is building the Bet HaShem, whereby the Breath of YæHúwaH is united with our collective Breath. **The collective Breaths of all names is the House of YæHúwaH and comprises the Name of YæHúwaH.**

Breath is subject to the carnal mind and to the carnal vernacular of words until the Judge of Dan alters the verdict whereby what is of Light is no longer subject to the nature of the flesh in any manner. The use of words and vocabulary development correspond to the maturity of Dan. As Dan determines direction, inwardly to be according to the Enlightenment of Mind, Breath will then reveal to the entire house members their composition as a Burning Bush—an assembly of inner branches of Fire. Seeing the burning bush is an inner visualization provided by Breath. From this point of awareness there is a reorganization inwardly. The Mind of Aharúwan stands apparent with the Breath to support the progression of all members. For until this stage of awareness/progressions, the priest of Aharúwan remains silent so as not to waste the words of Breath nor to cast pearls before the swine. However, Aharúwan as the Alder of three years, has always been at the side of maShayh/Moses, but now becomes the interpreter and leader of the inner flock. Then follows a gathering of the Alders as a Council for the Breath. Via the

House of Aharúwan and the gathering of your inner Alders, the tribes are organized and realigned to be followers of the Enlightenment of Mind/Aharúwan and the Transmitter of Thoughts/Qahhath—The Breath verses seekers of the wudah/world. As a result there is a breaking off of carnal thoughts which will fall apart as a shell, and the inner power of Divine Intelligence becomes revealed day and night. The entire house of our Name moves upwards through Metsryim—body forms.

The formative mind within our manifestation is the house of Pharaoh, being a depository of all things preformed and their consequences. The Mind belongs rightfully to Aharúwan, hence, when enlightenment comes within a dwelling, the Breath and the Priest of Aharúwan will rise above the holding power of Pharaoh. The chavarim/comradeship of Names will occupy the mind and override the edicts of the previous administration of thoughts which, being of Pharaoh and Egyptian, were via reflective interpretations and attachments to the manifestations. Due to the natural mind being attached to forms and manifestation levels, it thereby subjects all within its house to the consequence/karma that is a part of the administration of Pharaoh. As long as one remains attached to the manifestation and boundaries of strange flesh, so will laws of karma govern and intervene in your relationships.

The Head of all dwellings of Names is the House of Aharúwan—the composition of all enlightened thoughts; however, until the priest within you becomes manifest, the rooms are administered by Pharaoh for maintaining the form amidst all other forms. As Tehillah/Ps 104 states, all wait upon the priest to give them their food at the moadim/appointed times [Romans 10:14-15]. In like manner, the entire Union of Names is waiting for the Kohen haMeshi'ach to arise within the Collective Order whereby they shall be ushered into a new state of residence, for as the Mind comes to reside, so do the members. As the Mind of Aharúwan and the Breath of Qahhath establish a new residence for all Names, so shall all be ushered into a new era. The Mind, as the ALder of Breath, is the Expression of the Mouth that articulates and distinguishes the Voice of Breath, for Breath is a raspy veiled language. As the Light of Thoughts arise within one's dwelling, even as Aharúwan arises within Metsryim, so the mental faculties once held by Pharaoh are transferred step by step to the House of Aharúwan until all of the members of one's house are no longer under the regulation of Pharaoh, but all of the house, collectively, has risen through the lands of occupation into the realms of Breath—into Letters and Numbers whereby they qualify to enter into all of the Midrashim of the Wilderness Stages. Until that ascension, the members travel with the Breath and their ALder Brother/Mind who patiently provides stimuli to awaken the household unto the purpose of journeying through these veils.

The ALder of maShayh/moses/the lamb, Aharúwan, is the mouth of the Breath which gives the Breath faces, for via the Words that the Mouth speaks, so the Breath becomes expressed, moves with being, and resides according to configurations of words and numbers. Hence, a priest carries the States of Residence according to concepts that are being processed through the members and will not guide the house unto a state of residence to which they are not qualified. The aim of the priest is to assist the members of a household. A mind that neglects its members is like a parent that disowns their children. The priest enables the members to expand and to affirm their unity via which they can move—make progressions, for without their unity, they cannot proceed but are as the divisive members of the household of Yaaqov, stranded in famine.

## The United Branches of Dan and RAúwaben



The Branch of Dan has two sides as do all of the tribal families of a Name. Each tribe within us is a branching of thought, and no thought is whole without two sides whereby it becomes perfectly expressed and established. The other side of the House of Dan is the House of RAúwaben, for the eyes are the complement for every judgement. In the court room, the prosecutor desires eye witnesses, whereby a matter may be considered beyond reasonable doubt. But from what angle did the witness see the deed and under what influence or circumstances were they looking.

Dan and RAúwaben are the two heads of Wisdom that occupy the north and the south respectively. Thus when we consider the joining to branches, we are joining like kinds. That is, the six pairs of the Tribes are made up of united heads, united bodies/trunks, and united rivers of flowing thoughts of life. Dan and RAúwaben confer and unite together to make a whole expression/face.

In the case of the heads of the north and the south, Dan is dependent upon RAúwaben to assist in coming to true judgments. The way that we see another person, event or procedure is based upon Thought verses external considerations. Those engaged in these studies of the tribes shift their eyes from the external unto the inner structure of thought through which we continue in unfold the revelations forthcoming. We have been conditioned to behold and make decisions based upon fleshly sensations by examining surfaces and scrutinizing over forms. Little consideration has been given to the Thought behind every expression. There has been basically little teaching regarding the way that one looks at the wudah/world and the activities of Mind. The focus has been on the expression verse the Thought. ***When the focus of the eyes are on the expression of flesh, there is unclarity of judgment, and the judgment is weakened.***

The families of RAúwaben complement the House of Dan. Our eyes are kept in the south—in the direction of full illumination to complement the decisions in Dan being in the north. We are to see with favor upon all, to look for the wonder, to investigate, to search out the Principals of Unity in a matter, to discern the presence and activities of Light, and to gather and compose insights and verify thought expansions. As necessary, review the studies of the Tribe of RAúwaben, for until we are using the eyes in alignment with the families of RAúwaben, we have eyes, but do not see.

“To see” is the root of the word meaning “to fear” YæHúwaH/ 𐤅𐤁𐤍. Hence, when we behold the perfect order of YæHúwaH, who will not fear YæHúwaH and glorify His Name [Chazon/Rev 15:3-4]? True judgment is based upon the fear of YæHúwaH, and pertaining to this fear we are marked/distinguished unto His Name and recorded unto Life [Malachi 3:16-18/Yeshoyahu/Is 4:3]. With the fear of YæHúwaH we declare unto each other all that is being revealed which resonates in the highest heavens, for the eyes of YæHúwaH search to and fro in the earth seeking those who fear Names Unified. As we bring forth the branch of Yahúdah,

from the stem of Yishai/Jesse, we delight in the fear of YæHúwaH and accordingly make judgments [Yeshoyahu/Is 11:3].

The message of Dan to the head of RAúwaben is that we are all One. His admonishment is to see all Names as equal, each being an expression and position of One Breath/Reúwach. When we approach each other, do so with a bow in acknowledgment of the residing Breath. Do not be swayed by the external or limit the activities of Thought based on the physical. See past the physical, into the Thought of the Breath. **Keep in view the Union of Lights and maintain the position never to violate the primary values of the Union—the numbers of the Names one through nine**, for if we violate the values in our midst one with another, we are held in this dimension. The words of the Túwrahh pertain to these Numbers which carry the Thoughts of the Sayings. The Primary values to uphold in vision and judgment are: **one** is the force to Unify, **two** the means to bond, **three** the paths of communications, **four** the gates of messages, **five** the direct and indirect illuminations, **six** the joy and pleasantness of united Breaths, **seven** the states of perfection and completion, **eight** the living ascendant thought expressing totality, and **nine** the collective order of community. All of the Túwrahh sayings and commandments pertain to these numbers.

When your eyes glance upon the accounts of the Tanach (Old Testament), discern the Thought that is being conveyed lest you attempt to justify your deeds of flesh based on the readings of flesh. For such has been the corruption of the text within the minds of carnal readers. Some have killed, others engaged in whoredom, stolen, and others forsaken their responsibilities, justifying their ways of fleshly indulgence based upon a narrative from the Tanach/scriptures. Our eyes are to go deeper into the text to mine out the message that is robed with a garment of Wisdom. For Wisdom conceals a matter, and if you are looking at the shell you have yet to behold the pearl that lies inside. Thus one behaves after the external rendering and subjects their members to the karma of Pharaoh—the natural mind.

### The Divine Order of the Families of Dan for their Expression of Wisdom

מַחְשַׁבְתֵּי דָן יִבְרָא עֲלֵיהֶם

Dan's single offspring, **Shucham**, conveys the **Oneness of Judgment** and the Union of Breath. In judgment there are not two opinions. One Judge determines the sentence. Yet the offspring of Shucham are many as they proliferate **all aspects of judgment and extend the thought completely into all branches** of Mind. Thus we read that the Name of Shucham is for their—the complete expressions of Dan. *One family name, Shucham, carries and depicts the collective voice of Unity.*

The singleness of the Name, Shucham, conveys that judgment and the indwelling breath are indivisible. Out of the Breath, thought runs, and the language of the White Letters—out of the Mouth of Canaan—is aspirated so that the letters are projected and mulled over. The Breath of huHaALhhim (the Emanations of the Principles) began to breathe in the northwest quadrant—

in the House of Dan. From this corner of the tribal arrangements, the thoughts began to run to make a square.

We face the north each morning and evening for our daily bread at the Shulchan Panayim—The Table of the Faces. From discernment within the House of Dan we pursue/chase after the goodness and lovingkindness of YæHúwaH. **A Thought begins to run through all the camps until it runs full circle to the Table of the Faces—to behold the full expressions of all within.** We come with our faces lifted unto the serving priests at the Table, for our faces have been lifted by the rising expressions within us. We receive upon our tongue the bread for all our households. As the bread is arranged in pairs on the Table, so we receive one half or one side of the table in the evening for the camps of the west and north, and the other half or side of the table in the morning for the tribes in the east and south. We partake of the thoughts of Understanding in the evening which prepare us to receive the thoughts of Wisdom in the morning, being the Bread/formulations of grain on behalf of Yahúdah unto Aparryim—for values unto their adornment. We partake for Yishshkhar unto Maneshayh—for labor with transference. For as values are established within us, the next level of partaking is *for value implementation/labor* with a transference of thought devoted unto succeeding levels. We receive measures on behalf of Zebúwlan unto B’Niyman—for residing according to Principles. As we make transference/progressions via Maneshayh, we come to reside according to the Principles discovered. With the gathering of concepts/Principles, our vision capacity enlarges. Hence, we partake next for RAúwaben unto Dan—for seeing with discernment. And as discernment increases, so is our hearing faculty fed. We receive the measures of bread for Shamoúnn unto Ayshshur—for hearing/comprehending with affirmations. As we listen in this manner we come to speak out of meditations. Hence, upon our tongue the final pair of loaves are laid for Gad unto Nephethi—for all manner of communications with contemplations. As we are served the Bread of the Faces, so a climax commences in the north, which commences from the base of the skull and runs up and inwards to the top of the medullah, as electrical currents. With each succeeding measure of Bread/Thought formulations, currents of information, via Bread assimilation, runs ever nearer unto the center of the skull, until the last measure is served, and a rush fills the inner vein of the head and rises to crown with a full burst of knowledge and Light.

Breaths cause thinking. Thus, as two breathe as one, they think/consider a matter. For breaths are always considering their places of observation and thus residences through progressions, aware who is near, both in Intelligence and in space. Breaths are continually processing the expression and prodding Dan to ask, **“What is the expression before us to be considered?”**

Breathing in and breathing out is the manner in which we weigh everything. There is mercy with each inhale and there is judgment with each exhale. Our thoughts precede Breathing. Breathing is directed by thoughts. As our thoughts expand we create a circle—the motion of convex—breathing in, and the motion of concave—breathing out. We create a circle to determine all that is within Breath. In this way we encircle our thoughts. In this way Avrehhem encircled Lot and his household.

As we look at Letters of Shucham/שחם, we consider the Fire’s Unity/אש that rises into all levels/אש. The level of our water vessels are according to our level of thinking. The waters



within us are at the level of our thoughts, for they are mirroring the Heads. The ears and eyes function with fluids, and hence, what is heard in the ear is according to the level of the fluids concurrent with the progression of thoughts. Thus, one sees, hears, etc. according to the level/מ of their thoughts. Hence, do not restrain yourself to what is seen or heard at former levels of understanding, for as your thoughts expand so will your seeing and hearing be fuller.

As we consider the uniqueness of Shucham, we must ask why is there only one Name in the camp of Dan? **All judgment must be based upon Unity and equality without partiality.** Judgments are to be made whereby no preference or partiality may come into play in making a decision. Also, we hear that all Breath is one, and is indivisible. And knowing this, we affirm that the Breath in each one of us is the same Breath, being the Breath of huHaALhhim—of the One of Living Principles. Yet the Breath resides in separate bodies. How do we understand this mystery of Oneness manifested in separate bodies? We affirm that Breath has multiple expressions, and hence *every face appears to express the totality of YæHúwaH*. Further, via the body we learn all of the properties of Breath according to our Name. When we are willing to lay the body down, that is, to deny separateness, we enter into the more glorified House of the Unified Name. Hence, temporary separations lead us to affirm the perfect Unity of Breath, whereby we defend it even as all bees defend the House of the Counsel/Wisdom.

The united order of light formulates judgment for drawing out the Fire Names to fully express an assignment in the totality. These Names are the United Order of Light as the sons/unified extensions of Dan/ד/judgment/vindication/acquittal/litigation. Via Dan we put evil into chains. Our understanding results in value determinations and goodness, evaluation processes, weighing thoughts in the balance of Unity, applying the plumb line, drawing conclusions, and perceiving/distinguishing relationships of Principles and associated objects, etc. Such are the roles of the Offspring of Dan.

We have felt the heat of Dan during times we narrowly escaped a danger. The tone of Breath within the camp of Dan has caused us to pant quickly when we did something in secret, or was slowed as we decided to put an end to something. We give a sigh of accomplishment as we complete a difficult task. Our muscles tightening in the chest or relax with a great relief in reaction to the thoughts of discernment. As we regulate the Breath, our heartbeat responds accordingly. Through Dan, we may sense a great light radiating in the stones of our breastplate to determine a matter. All of these emotions and use of Breath come from the thoughts of Dan.

The Chiefs of the House of Dan are:

Achiezar/ אִיֹּזָר, Ben Ammishaddai/ בֶּן־אַמִּישַׁדַּי. These Names are the instructors and chief ALders of all parts of evaluation—the nose, lungs, and diaphragm—parts via which Breath passes and occupies.

We judge our lives not by what a man promises but what a man is and how a man walks. We know that if our journey should include death in the next moment, all that we would have to evidence our life's attainments is the degree of unfolding of our light garments and/or the state

of what is yet encapsulated. With us also goes the recordings of Beniyman, containing all events/deeds we set our hand to do, especially, the essence of the deeds, and not the external settings of the deeds. This we take to judge, for it conveys the organization of our Names and their development. To assist us in our judgements are the formulations of Dan:

The formulations/*unified extensions of Dan* are for Shucham/שׁוּחָם, from the root shuach/שׁוּחַ, meaning to walk, proceed, bend low in reverence, to be humble with acknowledgements, to inspect, uncover, dig, go deep, explore depths. The manner of our walk is according to humility and acknowledgement of others. What we decide or the judgments we make determine the characteristics of our work. The way we judge determines how we proceed.

Formulations of Dan lift-up and brings to the fore of consciousness every Principle to be unfolded in the light of Shucham. The final mem/מ (plural form possessive) denoting “their” walk or “their” humility suggests that **the manner of all the tribes determines the quality of the judgments we are able to make.** The essence of the formulation is to bend low in reverence and in acknowledgement first of what is present and secondly in regard to the matter being considered.

In making a judgment, let us foremost bow in humility to the Great Name of the Universal YæHúwaH, and compare our developments and decisions according to His universal balance of mercy and justice—the scales to determine the position and value of all things. Let us bow in reverence to the Great Lights of the Union and those assembled within us. Let us bow in honor to the ALders that stand with us. Let us bow in honor to those around us whom we have assignments together. Our position amongst men and angels are affected by our judgements.

We do well to judge ourselves and let others judge themselves lest we judge amiss and in vain. From this position of bowing we formulate the judgments of Dan, and without this position let us refrain; for until we are lowered, we will miss certain points since our perspective is less than full. Being lowly permits a view of 360 degrees versus other positions that may grant only 90 percent vision or less. We are to take the position of the horned adder, as given in the blessing to Dan from Yaaqov. The wispy sounds of breath exhaling from the lungs are as the sounds of a serpent. Buried beneath the earth as the serpent, yet ready to emerge from within the body is the position of the Dan. His eyes are opened, peering out through the sand to watch over the nesting of the Names within. His tongue may strike at any time to confirm the beauty beheld or may bite with a tongue of poison to put to death anything that comes to destroy or harm the embodiment of light energies within.

The formulations of Dan are for Shucham. All emanations are for giving reverence and acknowledgements—the purpose of making a judgment. The formulations of Dan are for determining Shucham—that is, for our walk, our proceedings in how, when, why, and where we shall go forth.

In our considerations of the Name of Shucham, we should review the spelling of this energy in Sepher Maoshah BeRashshith/Genesis where it is first recorded as Hushim/חֹשִׁים [Genesis 46:23, I Chr 7:12, 8:88], comprised of the same letters as Shucham but in a variant order.

Hushim/חשׁוֹם is the Name as it enters into the soul fields, the first quality of judgment. We are to analyze the expression that will lead us to discern the Principle. Shucham is the release or breakthrough of the Fire Name whereby the Shayin/W moves into the first position and the Chayit/חַיִּית into the second, denoting that by Wisdom we consider our assignments and our place amongst men. We look at a stage of development and performance which Chayit/חַיִּית conveys.

Hushim, translated as “hastens,” pertaining to those who make haste, is also rendered as to **be silent or the quiet ones from the root חשׁוֹם**. The later rendering is preferred, for as we first make judgments, we are still and quiet in heart, not to speak out before due consideration. We are not to mouth the faults of others but to be poised in evaluating the essence of ourselves. We silence the extraneous noises in realizing that those yet in process of unfoldment are assembling and learning their totality and unity of order. Should we focus on the faults of others we cause confusion and darkness to sweep in like a storm which clouds our eyes.

In observing judgments from carnal teachers, haste is the characteristic of their initial judgments. A hasty judgment dissipates as we allow the Shayin/W to take primary placement in our considerations, for then we will yield a lowly heart in reverence and in acknowledgement to the matters at hand.

### Summations

These—the United Order of Light are the releasing/drawing out/מִן of the Fire/W to express/mouth/פִּי the perpetual motions/views/עֵינַיִם to compose the totality/summation/סֵכֶם of judgment. The sequential statement to the formulations of Dan articulate the accomplishments of the judgment. *Each judgment is an affirming release/מִן of Wisdom/W and honors Wisdom to be manifested within our level of totality.*

All releases of judgment are to manifest our position of completeness. Why else do we really want to know truth or enter into a judgment/an evaluation? **If you judge another at one level, they will soon shift from that position and the judgment will mean nothing at all because it was attached to a certain act or stage which has passed.** But if you judge to release and honor Wisdom then Wisdom will reveal your stage of performance in regard to your completeness. The release of judgment will be valuable, for it will rid you of crimes and offenses. With Chief Achieozer in your counsel, you will not be dismayed but come to the actuality of your wholeness in YæHúwaH! Thanks be to AL for true and sustaining judgments from the tribe of Dan. Thus **the process of judging ourselves is to free ourselves and open the doors unto states of shalom/completeness.**

The total sum of the Fire emanations of the Shuchami are for mustering and evaluating our stages of development and actualization. They maintain us in an upright position so that we do not topple over.

The complete families of the Shuchami רמחמאמא אמתמא לר  
 for their summations/numbers/valuations אמממממממ  
 are four/inquiry/searching out coupled with sixty/just weights and balances מממממממ  
 according to ALphæh/Principles, ממממ  
 coupled with four hundred/insights/revelations within a collective residence. ממממ ממממ

***What is the value of the Shuchami?*** They search out a matter completely and then make a just decision whereby we maintain our kingdom of Names according to the Divine Order of ALhhim/Principles. The family/expressions of Dan open new doors for thought to break forth and they grant insights to structure/web together Light Principles within us. Each provocative decision establishes a light path for us to proceed within the center/Oyin as the spider web illustrates. Did you ever see a dark spider web? No. The webs are always rays of white light that provide paths and avenues to walk upon, to hang from, to arise and to descend; all threads are structured around a center of being one. What we catch into our web becomes one with us, even catching of glimpses of truth about ourselves, become part of our unfoldings. Great/nurturing is the creation of YæHúwaH to teach us all that we are in the Unified House of Light.

Gates opened/Δ are joined to light paths/פ of principles/60,000 coupled with insight of our inner Kingdom/400. As we walk in the rays of Light, we are offered to pass through the gates of the Kingdom of YæHúwaH and reside within the Kingdom of ALhhim—400.

*The Attitude of Being expresses correspondingly:* [Matthew/Mattithyahu 5:1]:  
 Expansive are those lowly in Breath/spirit, for to them is the Kingdom of the Heavens/Names. Expansive are the merciful, for they shall receive mercy.

According to the Fire we emit in judgment, so we share and receive. If we issue forth fires of hatred, then such shall enter into our heart. If we issue Fires of consideration, mercy, and favor, then such shall fall upon our heart. May all the gates of His eternal Kingdom be opened to us, that we may discern the fullness of our kingdom and maintain it according to the Order of ALhhim through the courts and judgments of Dan.

## TERMINOLOGIES USED WITHIN THE DOCUMENT: THE HOUSE OF DAN

This section of terminologies is provided to assist the reader to ascertain the information in this document lest it be hidden to anyone due to language. While the terms appearing in the document may seem to become a barrier, in essence the terms used are intended to carry the thoughts being presented, as other terms in the English language fall short to carry the thoughts being expressed. Some terms, when they are first encountered, may seem awkward to be grasped, whereby they may be perceived initially to be a barrier of communication because the form is different than one may be accustomed to seeing. Imagine if the English used during Wycliffe were in use today, those living today would not be able to comprehend the English of that era since it has changed considerably. Consider the changes in pronunciation that have occurred during the past 5000 years in the language of Letters. Listen to Arabic, Farsi, Hebrew, Samaria, Aramaic and you will note amongst these languages, coming from the same root, various pronunciations to carry the same thought. To discern the rendering of a word, it must be heard, and to be heard it must first be discerned, opened to the eyes. The modifications of terms in this document are for restoring the meanings and the utterances of the words as they are heard inwardly that the thought be carried forward through the frequency of the utterance.

Can word forms within vernacular languages, *e.g.* English, convey fully the thought of the Ancient Letters of Fire? Coming out of our mortal environment and corruptible thoughts necessitates that we enter into the *maDAVARIM—the wildernesses* which is a schooling and orientation to the words of Fire. According to the stages of the wilderness, we are equipped to speak the lands of light into being. As the words are heard internally, they bring forth understanding. The form of the word changes from one frequency unto another as we proceed from one level of thought unto another. According to the five frequencies of the wave of Shamoúnn [Simeon/hearing], the words are heard and the understanding is ascertained by the frequencies. Hearing inwardly the word spoken brings enlightenment, for though one may speak a word to mimic the sound of the letters that comprise it, until it is heard inwardly the hearer is closed to what the word means. Saying the word with an orientation of the Paired Letters breaks open the meanings contained within the words. The decision to alter the common spellings within this document of some rather common names has been made as long as it assist to carry forward the enlightenment/understanding of what is within the words and to give preference to the frequency of sound that is created by Paired Paleo LETTERS. Since the Paired LETTERS of LIGHT are the basis of the thought, the preference to the Paleo formulation of the word overrides the standard English formulation.

Understandings of messages come by processing the thoughts which are comprised in the words and their arrangement to each other into deeds/actions. Provided are a list of selected terms and their common contemporary form to serve as a quick reference to those familiar with the contemporary renderings in English translations; although if one goes back a few hundred years, even these terms English terms will vary in form. *i.e.* The word, Elder/forefather, used to be spelled as Alder and is retained yet today in the word, alderman. When did the E replace the A in such terms as Al to be El, Aparryim, to be Ephraim, and Alder to be Elder? Some terms are more defined than others in this section. For further understanding of the terms in this document, consult the Túwrahh Light Dictionary, Bet HaShem Midrash, [bethashem.org](http://bethashem.org).

### Terms:

**AL/℄℄**, the Name of United Order, the Giver of Seed/ALphæh)—the sayings of the United Order of the Lights, *lit.* The Seed/℄ rules/℄ from which comes the Rod to Govern all things; within the Seed Word is the composite of thoughts that dictate the activity and the form of all things, within the Seed Word are the Lights which come forth from the ALph Seed, in which are the Hhúwa-Úwah-Hhúwa Union of the Lights; commonly rendered as El/God.

**Alhay-Aurim/℄℄ 4Y4℄ 3℄℄** (Elohim/Gods of Lights), The Principles/℄ 3℄℄ of the Lights/Aurim. The term, AL'hay is the construct form of ALhhim, denoting to whom the Lights belong. The term, Aurim, commonly is rendered as Urim/lights; the letter A, depicting the ALphæh, is omitted in standard English. In giving preference to the Paleo, the A appears in the English language as AURim/lights. Without the Letter ALphæh opening within the Heads there is no Light. The singular of AURIM is AUR, commonly rendered as Ur. See further notes in RAúwaben/Reuben.

**ALhhim/℄℄ 3℄℄** (common usage: Elohim/Gods), the pronunciation of words is according to the interior harmony of values/numbers within the Letters; the balanced formula of the Letters that comprise ALhhim is (4) ℄ (10) ℄ (10) 3 (4) ℄℄ which indicates that the Letter Ha/3 is doubled in pronunciation to render the reading and pronunciation of the term as: ALhhim. As every Letter is a formula of the 1:1 ratio of the Name of ALOZAR, so then words are to be read as a 1:1 ratio. In the word of ALhhim the ratio is 1:1:1:1, the sum value being therefore 10 or the reductive of 1. Combinations of the Letters are the means to expand and multiply the Thoughts within the full Mind of ALOZAR. The combined Letters and the sounds that they make through the anatomical spaces convey the 1:1 ratio of Light and the equality of the Name of Shucham. In knowing the 1:1 ratio of every word, the Breath of Dan speaks through the Name of Shucham/equality the 1:1 ratio of every Word of ALOZAR. Therefore, what is carried by the Reúwach are the thoughts of perfect balance and harmony, through which the worlds of Light are formed. The ALhhim are **The Principles—Seeds that Govern all things, for within the ALhhim are the two Lights of the OYIN and the SHAYIN, both being the heads of the staff, being of the two Lights/33 the ALhhim govern all thought considerations and activities, which are extended through transmissions/waters/Breath distillations and crystallizations of unified thoughts; the House of Unlimited Concepts ever giving, expanding and revealing the Principles of Unity;** The ALhhim are the multitude of Seed Principles that are cast into the firmament as the stars. As each concept or Principle Seed is opened, the nature of its Light is seen. The ALhhim are paired; as nothing of ALOZAR abides alone. In the pairing of the Names of the Letters, the full counsel of the ALhhim is declared. The ALhhim is the plural form of AL—the United Order—the Unified House of Instruction.

**ALOZAR/4IO℄℄** (common usage: Eleazar), The Unified, Inner Core Name of the Collective Faces of YæHúwaH. The Name of ALOZAR is comprised of three parts: a Priest/AL, and a King/AR, and the Lands in which they reside/OZ; within the Union of these paired Names are the Lands of the Oyin-Zayin, commonly rendered as the Ten Lands. The Ten Lands are comprised of the ten Letters of the Paleo/Oovri/Hebrew—the Zayin to Oyin/IO,

which appear in the midst of the Priest, AL/ℓℓ and the King, AR/44. ALOZAR is the Name of the one referred to as Malkitsæddaq/Melchizedek, to whom alone we are to pay our tithes/wealth. ALOZAR is the sovereign of the Lands, being the UNITY/Achhad of Names, in which we live, move, and have being.

**ALphæh**—the sayings of the Seed that governs over all things, the Letter depicting the Number One, but not first in appearance, amongst the Letters of the ALOZAR, commonly Alpha, ALphæh, the Letter A; appearing through the ZAIN, together with comprises the Zayin-Alphæh House of ALhhim.

**ALPHIM**/אֲלֵפִים (Concepts, Thousands), Multi-Principles, plural of the term, ALphæh, denoting the value of thousands. Within the primary Letter, ALphæh, is the HaÚwahHhúwa configuration of thought according to the Union of Sides in ALOZAR whereby every thought is a stable wave of energy and capable of bringing forth the full spectrum of the Lights.

**Aparryim**, Ephraim, Ephrayim, offspring of the MÆYIM-TÆYTH pairs of Letters, from the root word, paryim/bullocks, the means to prepare and cultivate the Mind to receive the Seed, to generate growth and fruitfulness

**AR**, the Name of the King in the united Name of Malkitsæddaq/Melkizedek, one who receives the ALph, the Seed of Instruction from the Priest/AL. Through the reception of the ALph Seed, an expanse is formed in the midst of AL and AR for the blessings and multiplication of all Principles of Light; the Name of Abram/אַבְרָם is the House/בַּיִת of the Rayish/רַיִשׁ expanding/4, which is the friend/comrade of AL.

**ARAL**/אַרְלָא , rendered as a Lion, one valiant, a defender of the Alphæh and the States of Light in which it resides; *lit.* the Light of AL; the whitening of AL; the foundational basis of the Name of Malki-tsæddaq (Melchizedek); The Unified Name of the Priest/AL/ℓℓ and King/AR/44 from which all is given and unto whom all returns with blessings, the Name unto whom Avrehhem pays tithes, for as there is an expanse of thought in Abram, the fruit is reaped by sower. The Unified Pairs in ALOZAR from which all Paired thoughts of perfection come and abide in worlds without fault or corruption; commonly translated to be valiant, a transmutation of thought unto a higher level. ARAL is the basis of every ascension. As the Al'ph is sent forth it arises and expands to reveal its glories, each level of ascent unto its full revelation is by degrees of unfoldment within the 70 spirals in the midst of ARAL, each level is via 10—the extension of the Al'ph within the spirals, the spirals comprise the ten lands of Oyin-Zayin; ARAL is the network of Light, as the Semek/web in which all Names that are sent, therefore rendered as an angel/messenger of Light, one who is capable to overcome all resistance, traps, and corruption, whereby they abide in pure devotion for the Unified Names of AL and AR [Yeshoyahu/Is 33:7], rendered within the Name of YishARAL/יִשְׂרָאֵל (Israel), meaning the inheritance/possession/יְרֵכָה of ARAL/אַרְלָא, Lit. the Remnant/Retaining Thoughts/אַרְלָא of AL/ℓℓ.

**Ayil**, ram, an offering of Understanding

**BAYIT**, the house, means to develop and house a concept/Principle, the value of two amongst the Letters of the ALOZAR, commonly Bet, the Letter B; appearing with the ÚWAH.

**BeNiyman, Binyaman**/יָמָן בִּנְיָמִן, Benjamin; the House of the NEUWN/נִימָן, amidst which is the means to fully extend a transmission/מָן—**BeNiyman**/יָמָן בִּנְיָמִן is the House/בַּיִת of the NEUWN/נִימָן through which the Neúwn is extended to the 10th power/כֹּחַ through the distillations/vapors of thought/מָן that are within the NEUWN/נִימָן; the hand/*yamin*/יָמִין is in the midst/בֵּין, conveying that one extends what is in the midst through Seed/זֶרַע which is at the base of the YEÚWD; the YEÚWD denotes the beaten grain whereby the mincha is prepared; Binyaman is the means of the manna/*man*/מָן appearing with the dew of distillation, and as the Seed, depicts the fruit of Aharúwan's rod; the opening the sac of Binyaman in which is the ALphæh grain and receiving at their lips the cup of salvation, the silver cup, leads to the garments of immortality portrayed as the five raiment from Yúwsphah (Joseph).

**ChaúWah**, Eve, mother of all living, Wisdom of Understanding

**Chatat**, alignment offering, commonly rendered as sin offering.

**Chavar**, friend, comrade, plural: chavarim

**Dinah**, Name of discernment, the illumination of DAN

**Hhúwa**, the fifth Number in the Letters of the Paleo, commonly He/Hah, united with the GAMMAL.

**Haikal**, temple, term used for the dwelling of Light, a term of Understanding, compare Mishkan.

**Kavashim**, plural of kavash, meaning lambs.

**Kenoni**, Canaanite

**Kokavim**, stars. The stars serve to extend thought into fields of Knowledge which are regulated by Understanding. A star serves to expand Wisdom and Understanding unto Knowledge—to reveal all details of thought. Knowledge contains multiple seeds, as seeds that are scattered within a fruit, so are the stars. According to multiple thought branches or clusters of concepts so are the stars flung into a space. Each star is a seat of knowledge. The stars form a crown as the Seeds arise from the base unto the apex of our thoughts. Open an apple as see the crown of seeds inside. From whence have the seeds come? When ever a cluster of thoughts combine to form a word, a star appears. Every star is a Word cluster of YæHúwaH. The stars being flung into space are as Seeds that are dispersed from the loins. Around the expanding gases of thought, the ten lands of the suns and the planets are formed as the spaces for the stars which arise from the Breath of YæHúwaH. The planets are bodies of thought that correspond to the tribal camps within us; the stars associated with each planet are the fields of Knowledge that pertain to each thought cluster. As your 6 pairs of organs are set in the midst of your bodies, so



are the tribes set into the galaxies, six on one side and six on the other side. According to the paths of the Seed, so are all kokavim/stars and planetary bodies arranged in space, the great fields of Light that go out from the midst of the twelve centres. **AB, BC AND THE 32 EIRDANI**, names of stars in current science, referring to pairs of stars in the great river of Light called amongst the ancients, Parata, known as the Source River. Within the River are four sets of double stars or pairs: known today as the Theta and theta Eirdani, the AB, BC and the 32 Eirdani. These are the stars of the House of B'Nyaman/Benjamin.

**Laúwi**, Levi, to join, unite.

**Laúwim**, Levites, joiners

**Madai**, Name of the throat opening, the gate to the east, a Name of Yapheth/Japheth.

**Maneshayh**, the family of Yúwsphah/Joseph, commonly rendered as Manasseh or Menashe, offspring of the MÆYIM-TÆYTH pairs of Letters.

**MÆYIM**, the waters, means to transmit all within the Breath, the value of thirteenth amongst the Letters of the ALOZAR, commonly Mem, Mim, the Letter M; appearing with the TÆYTH.

**Nasak**, nesek, drink offering, of wine to convey the flowing of Understanding.

**Gamarrah**, Gomorrah, sheaves, compilations of Knowledge from the unfolding of the scrolls.

**OYIN**, the All Seeing Eye, consciousness, the sixteenth Number, amongst the Letters of the ALOZAR, commonly Ayin, the Letter O; appearing with the RAYISH.

**OZ**, the Letters of the OYIN-ZAIN, conveying the Lands in the midst of ARAL.

**OZAR**, the help, helpmate, strength, pertains to the body of thought that assist us to fully express the Principles of our Names, a title given to ChaúWah/Eve who assists the Adim, pertains to the spaces formed by the inhaling the Principles of Light.

**Parata**, River of Light, Euphrates, Source River of thought coming out of NEUWN.

**Qedmuni**, Kadmonite

**Qadam**, east, Kedem, point of origin.

**Qahhath**, Qehath, the Assemblers, Qahhath, Kohath, belonging to the House of Laúwi, serves to carry forward the Túwrahh, devoted totally to Enlightenment/Aharúwan—the priests/kuwhænim of Qahhath, whereby those of Qahhath serve to carry forward the illumination as those who carry the Ark upon their shoulders.

**QUPHAH**, the nineteenth Number in the Letters of the Paleo, commonly Qof/Kof, paired with the PAÚWAH, from which comes the sayings of the priests.

**RAuwaban**, Reuben, vision or seeing occurs when the ALPHÆH of AL enters into a Head/Rayish, the opening of the ALphæh/Seed gives light whereby one has seeing and is granted vision.

**RAYISH**, the Thought, Mind centre, Knowledge, the twentieth Number amongst the Letters of the ALOZAR, commonly Resh, Rosh, the Letter R; appearing with the OYIN.

**Shamóúnn**, Simeon, meaning to hear, offspring of the ÚWAH-BAYIT pairs of Letters.

**Sod**, counsel, singular of Sodom, means to open a Seed, concept

**SHAYIN**, the twenty-first Number in the Letters of the Paleo, commonly Shin, Sin.

**Taúwah**, the 22nd Number of the Letters, Tau, Taw, formed as a composite of two sides, or two Names that are joined, conveys the pairs of ALhhim.

**TÆYTH**, the ninth Number in the Letters of the Paleo, commonly Tet, paired with the MÆYIM.

**Tsephúwen**, north, side of mystery, source of thought as it opens to run, as ice melts and creates a river.

**Auri Tsephúwen**, Light of the North, northern light

**Tsur**, Rock, the Foundation of United Pairs

**Tsuri**, my Rock

**Yam**, west, seat of compilation and weavings the thoughts of the south.

**YishARAL**, Israel

**ZA**, conveys the seventh to the first Letters of the Paleo, commonly Zayin to ALphæh, the means to transmit the Seed, as the Zayin in the Name of the ALOZAR is the means to carry the ALphæh to the Mind/RAYISH.

### Concepts and Phrases:

**1. to smite them.** An action from the root nachah/נָחַח meaning that to arouse them, cause ripples to break out whereby the processes/nations are serving your Name for your habitation. You are to regulate your thoughts so that they are serving the expansion and binding of your Names into the House of YæHúwaH. As you prune a vine, so are the nations pruned and chastised to bring forth more expressions of Light within your branches.

**2. We are to consecrate/מָדַד every process of these ten states** unto the revelation and extension of a Name. This action has been mistranslated “to destroy,” and if we did destroy them, we would not have the great benefit of these processes nor the inheritance of possessing these processes for the full operations of our Names in Light. It is absurd that we are to destroy the inheritance that YæHúwaH gives unto Avrehhem and those of the Covenant.

**3. We are retain our position of Name.** Therefore we are not to intermarry with these nations, for we are not to subject the Name unto the process of extension whereby the Name becomes mixed/bonded to the process. To join the Name with a nation is the captivity of Assyria. To become joined to the process is to seal up the openings/nodes through which we are to branch into full bloom. Should we make a covenant with them, we restrict our Name to a process and therefore reduce the frequencies of our Names activities. Rather we are to maintain the Unity to YæHúwaH unto which we belong . We are to appropriate the grace and favor upon our Heads to facilitate the attainment of Knowledge and not to place the fat portions of grace upon the processes that serve us. Each process operates at various levels, thus should we unite our offspring with them we would commit our level of residence at a fixed level of dwelling. We know no limits to which our Name shall rise to into the Kingdom of United Names. We belong to the collective of Names, and we are cautioned not to place restrictions or ceilings over our head that limit our expansion and activities in Light. May the One of ALhhim so move us forward into our dwellings of Light.

---

## The Story of the SERPENT The House of Dan

When you are sent into the world—a place of concealment, you appear as The Serpent amongst your branches. Your garden of trees are the result of drawing out the branches of your Seed, upon which you climb and speak your words of discernment. The Serpent and its generations are the threads woven, written in circles and spirals as contoured ears of Shamoúnn, coiled-up within the parables of scriptures.

The serpent of Dan takes up residence in the body of Zebúwlan—the Body of Light from which you originate. In the sequence of the offerings, the Dan rise upon wood of Zebúwlan—through the coiled rings of Light from which you are spun. As Dan flames within the wood of Zebúwlan, your serpent rises upon its pole of Ayithamar—your skeleton. Your serpent expands its ears of Shamoúnn depicted as the cobra's head emerging upon the head of Phærooh./Pharaoh/states of consequences.

The Fire in the Serpent of Old is the House of Dan, the origins of your lives and their progressions. By the Fire of the Serpent of Dan you change you garments, shedding them in progressions unto ascending upon your inner pole of Semek/פ. The ultimate destiny of your Name is noted as Dan verifications of BaarShevoo (Dan to Beer Sheva, ALphah ShmúwAL/1 Samuel 3:20).

There is also the serpent, known as the devil, who speaks of the outer nature, the body in which your Fire takes up residence. This serpent causes you to believe—put confidence in things that are not true—that which cannot endure to substantially verify the ongoing nature of your Light. Hence, by this serpent—the use of the tongue in particular, you deceive yourself by serving the outward nature and interpreting what is the Truth to be a lie.

When the Words of your Name are not understood, forms of religion rise as bodies of darkness. These groupings of interpretations are noted frankly by the Chassidim as “institutions of satan.” In such schools the eyes are veiled to what is created without hands—the patterns of Light of Numbers and Words by the Names of Yahúdah and Dan. The Name of AchyiSemek of Dan takes the Numbers of Yahúdah: 010, in which are the Lights .5+.5 of Chækúwmah and Bayinah, to create your dwellings. The House of your Name is built upon the Stone of Shamoúnn in which are assembled the gems of your Name into an imperishable dwelling. From all that is in the SEED—the 12 Houses and the Names of the 15 Fathers, Dan breathes upon their Numbers to formulate patterns of Light for your Name to dwell in the glories of YæHúwaH (SYM/Ex 31:1-11; 35:10-19, 30-36:3, 38:22-23).

When Truth is made/read to be a lie, the lower frequency interpretations of the Words of ALhhim and their corresponding practices ensnare the Soul and Body of your Name into a trap of illusion via imaginations and conformity to the world—the body of concealments rather than to the Voice of Dan. Instead of believing the Truths that your Body of Rings of ALhhim are your Temple, there is an advocacy to serve a substitute edifice, or the profile of the body itself, that cannot endure the ages of Dan. Look beyond what you see in the mirror unto the bones of Semek that uphold you as AchyiSemek. Instead of believing the Truth that the patriarchs are from above, they are presented as mortals that die and perish. MaShayh/Moses is the most meek lamb/Shayh drawn out of the waters, but religions

describe maShayh as an authoritative leader who sets in stone perceptions of the world, rather than those of the flashing consuming Fire. And the list goes on and on, whereby the focus of faith becomes what is created by hands rather than by Dan. These contrasting points of belief are known as The Teachings of Light in contrast to the doctrines of darkness.

The Wind of the Shayin/fiery Serpent causing branches of Semek to shake to affirm what is connected to the core, being unmovable. Hung upon the scales of the bones, the serpent of Dan provides paradigms of judgments/appointments unto bringing all of your soul to Baar Shevoo—the Well of Seven Eyes.

Your tripart habitation continually analyzes what is in the core of your Being. Your secret place—qudashqudashim is at all times your refuge for your twelve distinguished parts and their habitations. The outer court does not imply corruption nor strangeness as it is a state in which your Spirit and Soul forms for your dwellings as you appear. Though the outer court refers to the body of flesh, flesh is not limited to what is assumed to be mortal. Being composed of strands of Light, the flesh is an assembly of the Faces of YæHH. The flesh changes according to the status of the Seed. Upon serving the evolution of the SEED, the flesh gives way for your next ascension. The Anointing—MeShiæch speaks: in eating my body—my flesh—a generation of the oil—you have eternal-ongoing life. Through bearing the glories in your SEED, as gemstones, you enter into the three states of Light according to the patterns of the temple above.

The passion for Truth is the Fire lit in the wood furnace of your bones that flames into the inward parts. Dan reveals the Light that composes a dwelling for itself whereby you know yourselves intimately unto there are no strangers amongst you. The thoughts flow from bowls of sweetness, agreeable words. The goal is to be unified consciously without demise. The lights in Dan transform the carbon nature of stars in you unto imperishable gemstones for its dwelling. Meaningful relationships between you, ALhhim/the gods and others are based on the levels of intimacy. When the connections are not made to the core and its courts, than outer connections cannot sustain the inner illuminations.

We must ardently believe in the Words of Dan to escape the corruption of the world that perishes. The WORDS of DAN are Truth, the ultimate judgment that comes to the crown of your anointed head of meshiæch. The Judge rises and takes the sword of King Shúwlmeh/Solomon to distinguish the true Mother to be Yerushelyim above from the city of harlots who kill the children by suffocating their spirits. Your Mother above has compassion on your Name to teach you the Words of freedom, whereas the mother of religious institutions enslaves her children to serve vain venues of their own inventions/interpretations. The judgment/discernment of two mothers is the ancient parable of two women in which your SEED-NAME of Avrehhem/Abraham enters the domains of Light. The quick flash of the sword brings life or death to the hearer of the Word.

In all of your thoughts and deeds, you discern if you are living by the Words of Truth or if you have entered in shadows cast by the Light to lead you to Aharúwan/Aaron. If your orientation to living is the Names of the Kingdoms or the way that you conduct trade, let all be according to the Words of ALhhim that do not perish. By your faith you appear to dwell now and in your next progression. You decide to abide in the outer, the inner, or the inner most courts of Light for your habi-

tations of Shamoúnn. As you make your full ascent you enter into the QudashQudashim from which you are born (CHP/Numbers 21:9, Yahuchannan 3:14, 20:17; Eph 3:12).

Dan speaks from incorruption unto attaining the incorruptible abodes. What is spoken by the Shayin Spirit of Fire are Words of ALhhim which live and abide worlds without end in Semek.

As you fulfill the paradigms of Dan you bring together the heavens and the earth as one. The Glories of Yaoquv return to the Land of the Fathers. What you have learned and bring out of your treasures as gifts are presented to Oshauw/Esau to achieve mastery of forms entered and to bring all things in the earth dwellings in agreement with the heavens/Names. This is known as the great summations of the heavens and earth as one, the fulfillment of the Days of Dan unto worlds to come (Eph 1:10).

The oylah ascension is unto the Heads of Names, commonly the Heavens. What is sown in earth is a harvest to the heavens, whereby whatever we do in earth is laid up in the heavens as the harvest to their Names.

You are the planting of YæHuwaH. Three times a year you come to present your tithes from the cultivations and fruit of your Name, whereby the parable says: Avrehhem—via the expansions of the Father in your Seed, pays/contributes the wealth/tithe/tenths of Malekkiytsedeq—unto the mastery of perfect alignments in right standing with the Names in the heavens.

As the Father sends—declares you to appear, so you declare the 12 in you to rise and come forth that you have the evidence of your 12 baskets full. The Fathers send forth their Shayin Oyin — Wisdom and Understanding, whereby it is said that Yahushúo—the Shayin Oyin of YæHH comes/appears. The one believing in the Son has both the manifestation and the Source of the Fathers, together as one, whereby you are not divided into the conflicts of form/flesh and source/spirit.

You are sent into concealed waters and skins (the world) that you may turn them into pools of wine and smoke as offerings to YæHuwaH. As you transform your waters into the wine of the ages and as you bring forth your offerings of blood and beasts, you are appearing as the Heads of Names who are able to overcome the concealments, thereby testifying by your Name to be of the ascendant masters who are transformed by instructions and obedience. As you rise from the earth body, you bear your stalks, sending forth your 12 branches from your sides that you may bear the Fruit as a harvest unto Shemayim—the Heads of Names.

During your journey you come to purify yourself from vain thoughts and deeds that put yourself above the Names and your comrades. You realize that the Name in you is above your body and dwellings in earth, and all that is in the earth is subject to your Name as well as holy ground to bear the harvest of your Name.

Can the earth or any sphere keep the moon and sun not to rise? Is there any thought of darkness or gloom or depression that can hold back the Light of Oyin Shayin? And what is the result of their ascensions? The Seed in the earth sprouts and creates a harvest according to the season of the Lights to bear the Faces of YæHH. Are you now understanding that you are Yahushúo—the sum of Shayin

Oyin which is sent from above in the seasons of years to bear your harvest? And when the oil in your SeedName rises there is the meShiæch/messiah appearing as you have been sent as the anointed, whereby your House/Body is full of Light burning from the oil in your lamps.

You have 7 lights to form your fruit from your 7 rings and interwoven Strands, whereby you are doing the will/purpose of the Heads of Names—the heavens by bearing fruit—the Faces of YæHH through which you are one with the Fathers, affirming your gifts and Name. Is there any other purpose of planting a seed than to generate the harvest of that kind? Or do you think the plant should busy body itself with other things than being rooted in the Seed foundation of Shayin Oyin to bear its glories?

As you affirm the OYINSHAYIN in your Seed, you cleanse/purify yourself to bear the Lights of YæHH and the full spectrum of their Faces. Do you think you are to tell others stories written 10-2000 years ago without the testimony of your Name. For when you are yet blind to the Light of YæHushuo that is in you NOW, you are yet seeking to find and know yourself.

There is the beggar by the gate who cries out for silver and gold... Is that you sitting there not realizing that you can walk? That you can jump? That you can dance? Until the ROCK in you, that ROCK upon which your stones are aligned and hung, built up to bear the glories of your Name, comes and speaks to you. I do not have the silver and gold requested of the outer world, but listen, hear, as Shamoúnn is activated in you; in the Name of Yahu-SHayinOyin, you are whole. Through Shayin Oyin in the Voice of your Stone crying out, you are healed, made whole (Yúwspah/Luke 19:40). Get up—Rise to the heights of the Mountain of your Name.

There is a difference in perspective that you will be healed... and that YOU ARE whole as such is your total composition. The Voice of Shamoúnn affirms your salvation and your total redemption.

What has been a mystery has been unsealed to understand the formulation of meShiæch in all peoples, whereby every Eye Sees.... Via the Numbers of Dan/דן, you have access to Names and their states, both to enter, prosper and go out unto subsequent states of Light. Upon the foundations of Nephethi and Gad, the Numbers of your Name are activated and projected through your Words. The Name of Dan/דן in the North extends itself via its sacrifices in Nephethi unto the gate of the East as the Dallath in YahuD/דאח unto the composite sum in the West, as the final Letter in Beniyman/מנ. By triggering and managing the Numbers of your Name all things are formed for your Spirit to reside. From the givings of Dan your SEED is formed whereby you come forth from the Lands of Kennon/Canaan to enter into manifestations/Metsryim/Egypt. Through your Body of Dan, your Spirit perfects its Stone Crown Jewel to be placed in the House of YæHúwaH (SYM/Ex 31:21, 35:34). Your SEED rises, as in a plant, to form your Crown of Judgment with masteries, anointed, filled with oil/meShiæch, in which the diadem of your Name shines as your star of destiny.

We become accustomed to certain phraseologies; however, when the Light in the words open, then we hear the meaning in them. *e.g.* The saying: I labour/travail in prayers, groanings and in teachings until meShiæch is formed in you... Gal 4:19. How does this occur?

In Shamoúnn, the process of your new creation is heard with distinction and simply. As the threads of Oyin Shayin are drawn out of your SeedName, the formulations result in meShiæch—the Oyin Shayin of YæHH formed in you. Through the strands of AL/31, Wisdom and Understanding are transmitted. And being heard, they are spun in your respective parts unto the manifestation of meShiæch in you.

The Strands of 15+16 and 1 +30 form the two sides of your bones. As Lights stream from the Faces of ShmúwAL and Yetschaq in YæHH the bones are formed and quickened to be the inner core of the body of meShiæch. The stands of AL 1+30 from the liver and kidneys for the Light of Yahúdah. Hence, within the bones is the blood for Yahúdah (30) to purify your members. According to the Numbers of your Name, which are laid in the bones, you are called unto your service. (CHP/Numbers 4:32)

The Strands of 14+17 and 2 +29 form your nerves of Qahhath/Kohath and your glands of stimuli for Yishshakkar, respectfully. The houses that you enter daily are according to the thoughts you are transmitting and the labours of your Spirit. When your spirit agrees with the strands of your Name, then you enter into the House of your Name on the shavbet, whereby you receive the promises to abide in your Light from which you do not go out/depart/forsake. You have woven your habitations unto the Faces of ALBayitAL and BaarLeChaiRai. This is your inheritance in the arrangement of Stars.

*e.g.* the Strands of 5+26, and 11+20 form the right and left ears respectively. As Lights stream from the faces of Malekkiytsedeg and BaarShevoo, the ears are formed as the hearing of meShiæch.

Through like strands of the Faces of YæHH, the Lights are deposited and woven into the Body of meShiæch, whereby the Shayin Oyin of YæHH — Yahushúo is formed in you as your Fire is encountered and transmitted through Shamoúnn. The oylah ascension is unto the Heads of Names, commonly the Heavens. What is sown in earth is a harvest to the heavens, whereby whatever we do here is laid-up in the heavens as the harvest of Their Names.

You are the planting of YæHuwaH. Three times a year you come to present your tithes from the cultivations and fruit of your Name, whereby the parable says: Avrehhem—via the expansions of the Father in your Seed, pays/contributes the wealth/tithe/tenths of Malekkiytsedeg—unto the mastery of perfect alignments in right standing with the Names in the heavens.

As the Father sends—declares you to appear, so you declare the 12 in you to rise and come forth that you have the evidence of your 12 baskets full. The Fathers send forth their Shayin Oyin — Wisdom and Understanding, whereby it is said that Yahushúo—the Shayin Oyin of YæHH comes/appears. The one believing in the Son has both the manifestation and the Source of the Fathers, together as one, whereby you are not divided into the conflicts of form/flesh and source/spirit.

You are sent into concealed waters and skins (the world) that you may turn them into pools of wine and smoke as offerings to YæHuwaH. As you transform your waters into the wine of the ages and as you bring forth your offerings of blood and beasts, you are appearing as the Heads of Names who are able to overcome the concealments, thereby testifying by your Name to be of the ascendant



masters who are transformed by instructions and obedience. As you rise from the earth body, you bear your stalks, sending forth your 12 branches from your sides that you may bear the Fruit as a harvest unto Shemayim—the Heads of Names.

During your journey you come to purify yourself from vain thoughts and deeds that put yourself above the Names and your comrades. You realize that the Name in you is above your body and dwellings in earth, and all that is in the earth is subject to your Name as well as holy ground to bear the harvest of your Name.

Can the earth or any sphere keep the moon and sun not to rise? Is there any thought of darkness or gloom or depression that can hold back the Light of Oyin Shayin? And what is the result of their ascensions? The Seed in the earth sprouts and creates a harvest according to the season of the Lights to bear the Faces of YæHH. Are you now understanding that you are Yahushúo—the sum of Shayin Oyin which is sent from above in the seasons of years to bear your harvest? And when the oil in your SeedName rises there is the meShiæch/messiah appearing as you have been sent as the anointed, whereby your House/Body is full of Light burning from the oil in your lamps.

You have the 7 lights to form your fruit from your 7 rings and their interwoven Strands, whereby you are doing the will/purpose of the Heads of Names—the heavens by bearing fruit—the Faces of YæHH through which you are one with the Father, affirming your gifts and Name. Is there any other purpose of planting a seed than to generate the harvest of that kind? Or do you think the plant should busy body itself with other things than being rooted in the Seed foundation of Shayin Oyin to bear its glories?

As you affirm the OYINSHAYIN in your Seed, you cleanse/purify yourself to bear the Lights of YæHH and the full spectrum of their Faces. Do you think you are to tell others stories written 10-2000 years ago without the testimony of your Name. For when you are yet blind to the Light of YæHushuo that is in you NOW, you are yet seeking to find and know yourself.

There is the parable of the beggar by the gate of the temple who cries out for silver and gold... The parable describes you sitting in your path without realizing that you can walk—make progress! Upon hearing the Voice of your Rock/Kayphah of Shamoúnn you can jump; you can dance; you can get up to new heights. You are as the beggar waiting at the portal of your divine dwellings. There you sit expecting something of charity until the ROCK speaks in you, that ROCK upon which your stones are aligned, hung, and built into a dwelling to bear the glories of your Name. The Rock of your Name speaks to you assuredly whereby you have strength to surpass your imposed limitations of idleness. Hear the Voice of Shamoúnn! “I do not have the silver and gold as things of the outer world, but listen, hear, me, Shamoúnn; you are whole/healed in the Name of Yahu-ShayinOyin. The Voice of your Stone cries out (Yúwsphah/Luke 19:40)! You are healed, whole, get-up! Rise up to the heights of the Temple Mount.

There is a difference in perspective that you will be healed... and that YOU ARE whole, by fully acknowledging that you are ShayinOyin—the Fire in the Eyes of your Spirit’s composition. As the Fire of Dan rises through your serpent’s dwelling, the Eyes of your Name appears in your wings like

those of the moths. The Voice of Shamoúnn affirms your salvation and total redemption whereby you pass through the concealments (world) into the glories of your Name.

What has been a mystery is now been unsealed to understand the formulation of meShiæch—the ascendant Oil in Seed rising in all peoples. Your Eyes See the appearance of Shayin Oyin—the very Faces of YæHH within yourself (Metiayæhu/Matt 24:30, Menachem/Mk 13:26).

One becomes accustomed to certain phraseologies; however, when the Light in the words open, then you hear, to comprehend the meaning in them. The saying: I labour/travail in prayers, groanings and in teachings until meShiæch is formed in you... Gal 4:19. How does this occur?

In Shamoúnn/יִשְׁמַעֲנֵנוּ, the process of your new creation is heard with distinction and simply. As the threads of Oyin Shayin/OW are drawn out of your SeedName, the formulations result in meShiæch. The Oyin Shayin/OW of YæHH is formed in you. Through the strands of AL/31, **Wisdom and Understanding are transmitted from your Name in the heavens to your receptive dwellings** in earth/body. Upon the strands of AL being heard, as those of a harp, messages from the Faces are spun in your respective parts unto the manifestation of the ascendant/meShiæch in you.

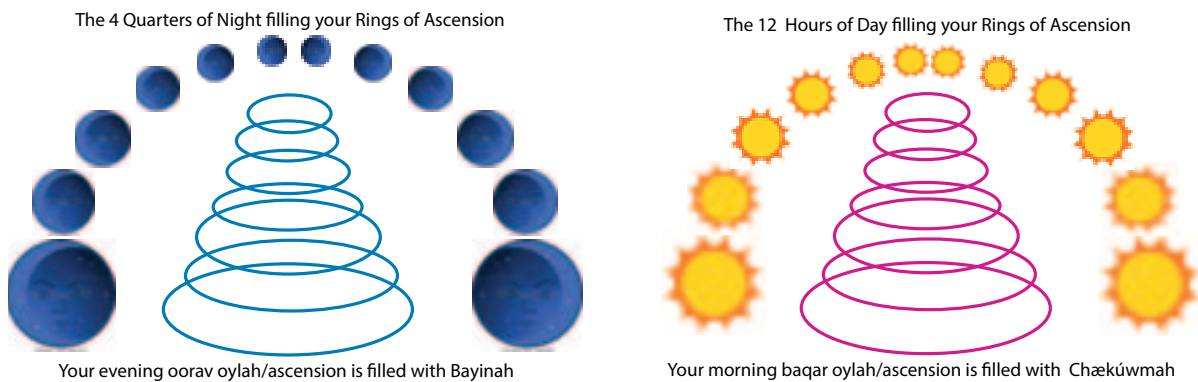

*e.g.* the Strands of 15+16 and 1 +30 form the two sides of your bones. As Lights stream from the Faces of ShmúwAL and Yetschaq (15+16) in YæHH the bones are formed and quickened to be the active inner core of the body of meShiæch. The Faces from the right to the left—Yetschaq to ShmúwAL, form the body of blood that comes from the bones, namely the organs of Yahúdah—the liver and its filter system of the kidneys.

*e.g.* the Strands of 14+17 and 2 +29 form the nerves that carry your Light as the House of Qahhath carries the Arúwn/Ark. As the messages are transmitted, the Faces of BaarLeChaiRai/2 and ALBayitAL/29 form your surrounding ring of consciousness of Yishshakkar. Why and how you do what you do are determined by the activations of your labour glans. The sustaining Faces of ALBayitAL/14 and BaarLeChaiRai/17 develop your endocrine glands to perform the Words of TúwraHH by the Hand of maShayh of Qahhath/Kohath, which affect the professions and placement of your Name amongst the hosts of Light.

Strands of 13+18 are from the radiant Faces of Yaoquv/Jacob/13 and Reshun/18 which form habitations of Zebúwlan. The Light of your Name is spun into skins for your habitations. These

fibres of AL, from the Faces of Reshun/3 and Yaoquv/28, provide the tissues that surround you as the Body of Gershun, HhaLaúwi/the Levite, in which the Light of your Name dwells.

The strands of AL, 4+27, stream from the Faces of Avrehhem/4 and Ayithamar/27 which form the right Eye of RAúwaben. The left eye is spun by the Ayithamar/27 and Avrehhem/4 for beholding Understanding. The Palm of the Isles of your Name—Ayithamar are for the Seven Stared clusters of Pleiades: the Seven Sisters who are daughters of Atlas, a Titan. who holds up the sky personifying Ayithamar. Upon the pole of your Name, Seven Eyes in your Seed are expansions of Avrehhem.

From the Faces of YæHH, Strands of 5+26, and 11+20 form the right and left ears respectively. As Lights stream from the faces of Malekkiysedeq/5 & 20, and BaarShevoo/11 & 26, the ears are formed as the hearing of meShiæch. The ears are the seven deep wells of the Spirit. Upon hearing all in your Name, you rise to masteries. The culmination of your journey is from Dan to BaarShevoo—Beer Sheva, called the Way of the Patriarchs. This is the final stop before the ancient wilderness—the means to fully extract the Words in your Name, and thus a point of departure for your spiritual journeys/progressions (SMB/Gen 16:8; 21:17; 46:3-4; 1 SepherMelachim/Kings 19:3, 1 ShmúwAL 3:20, SMB/Gen 21:25-34).

The mouth and the Words of your Name are the depository of the strands 6+25, as they are the gathering of the Faces of ALozAR and Aviyahua. The strength of your Seven Rings of OyinZayin of AL are in the Breath of your Spirit of Aviyahua that composes the Words of Gad. The formulary of 6x25 and 25x6 are the sum of 300/Shayin, the Fire of your Words.

Through strands of AL/31, the Faces of YæHH are deposited and woven into the Body of meShiæch, where by the Shayin Oyin of YæHH — Yahushúo is formed in you. The strands are transmitted through Shamoúnn by which Dan creates your abodes.

The strands in a seed form the body of the plant as they are activated and drawn out by the Lights. In this

*Paradigm of Being—Why you are where you are is that you are Caught by the Lights.*

*You, as all things, are a formulary of the Numbers of Light from the generations of the Fathers. Your body and her parts are composed of 15 strands of AL/31 woven into the choice fruit of your Name. Your weavings of tissues are hung upon the branches of their Heads.*

*In being formed, you are caught in a body. By the Fire and Waters of the heavens, you are trapped into dwellings, as a net woven of Light, from which you will be set free with an abundance (Tehillah/Psalm 66:11-13). The type of dwelling corresponds to what is deposited in your Seed as a storehouse of gifts. The generousities of what is given to you are your selective assignments to engage your Name into services of the Light appointed for your appearances. As the Light dances in the fields of the seasons, your Mother carries you along hand in hand. Though learning of Her joys with understanding, Her Words rise through your veils, whereby Her Voices are heard with clarity in your inner sanctums. Upon you coming in agreement with the Life in Her, the chains which have held you, for your schooling, break, as chaff cracks around the SeedHead to release your glories. In that Shayin+Oyin—Wisdom and Understanding are in your SeedName, from your beginnings, salvation/ShauwO is within you. You activate salvation and the saviour ever present in your Name by believing in/attesting to the Shayin Oyin of your origins. In being freed from your net, you crossover from your states of boundaries to enter into Her domains/kingdoms. The parables in the TúwraHH/Torah are composed to high-light steps of your progressions and transitions to be read with profit.*

like manner, the strands of the Faces of YæHH within your Name are given through recalls and graces of ALiyahu to make a straight path in the assembly of your Words and their Rings. The messages of Shayin and Oyin are carried through Shamoúnn/hearing to formulate meShiæch within you, whereby you appear as the Anointed from which your Name is called and chosen to rise as Yahushúo. Hearing is your basis/foundations of believing—comprehending the invisible coming into realities. How can one believe to be in the Offspring of YæHH until they first HEAR the Voice of Shayin Oyin? As you hear, so you are (Rom 10:14).

The paired 15:15 Faces of YæHH are woven from the two sides of your Seed. From your two sides of the Light, your body is fashioned. As the strands of Faces are drawn out from your SEED, you form their Body, as Their CHILD, whereby in you rises the meShiæch as the oil rises from the Seed that ascends. During the courses of the last moons in a cycle, the strands of YæHH are compiled one upon another to set in place what you have achieved through the courses of your offerings.

The strands in your seed form the body/residence of DAN as they are activated and drawn out of your Seed by the Lights of YæHH. *Evening and morning you spin, by your Breath of Dan, the serpent-spiral of your dwellings to appoint your Name in its dwellings.* The 30 Numbers of your Name and the Numbers of ALhhim are woven through your daily ascensions into your Seven Rings—the Eyes of ALhhim. The spiral of your oylah ascension is filled with the Lights of Chækúwmah and Bayinah. The base of your spiral (from your loins) is greater whereby the Lights of the sun and the moon appear larger as they rise unto their crowning in the peak of your spiral. As you make your daily offerings you open the gate to your mishkan, the door in which you enter the body—the vulva from which the blood flows. From the base—your wide ever appearing horizon of destiny—you rise through your imprisonment of the body as depicted in the ascent of Yúwsphah/Joseph until coming to the crowns of mastery of all processes/nations—to the peak of your mountain-head. The Crown of Lives rest upon your brow as your Seed is cultivated in states through Shamoúnn. Understand the Crowns of Tsædda-Tsædda are appointed to rest upon the ears of Shamoúnn. Surrounding you at all times are the Lights of the Queen from whose chambers you are born. From the sides of Light in their Dwellings, you are called by Name unto your appointed service in the domains of Dæúwd/David.

As your SEED of Avrehhem expands, you devote the wealths (tithes/tenths) unto your mastery, whereby it is said that Abram appoints tithes to the enlightenment/kuwahan/priest-servant that enables you to attain mastery—Malekkiytsedeg. With this goal in mind you rise by the Light of your Origins to the white throne judgment of Dan as the Judge/Discerner of the Ages.

Dan spins the Numbers of your Name through Shamoúnn in the cochlea, whereby you appear in the Light of your origins of Ayshshur. Shamoúnn is “an ever present help” in trouble/challenges/progressions as you draw out of your Seed the strands of AL.

You first heard—from above in the chambers of your Name—the design of the House of YæHúwaH, whereby you are able to manifest and enter into the sacred Temple by Liah, Mother of Wisdom/Chækúwmah. For by hearing the Voice in your Name, you resonate the Light to form your dwellings. To say that YæHúwaH creates the heavens and the earth, means “The Collective of Names” is appointed to abide together in the Fields of Light to enter into their appointed places as

they hear in their Spirit. Dan of AchchiSemek (Upholder/brother of Semek/𐤁, the Staff) is given the design of the 30 Numbers of Yahúdah in your Name to teach you, regarding your services and dwellings, in the unified inseparable Houses of Light to be achadd/one. The Spirit of Dan causes the Numbers of your Name to sparkle from its offerings in Nephethi. Upon giving itself wholly, Dan takes the sum of your Numbers, with skillfulness, to appoint all kinds of work: engravers, designers, embroiderers in blue, purple and scarlet stands of AL—as yarns and fine linens, weavings of the Worker of ALhhim to enter into their joyous designs of habitation. By your Numbers of Yahúdah, you have access to acquire all things gifted to your Name in the heavens and her states of residence—earth. Upon these Numbers the blessings of Aparryim rest to your full ascent.

It is given in your Spirit to teach. Via the unity of Numbers of BetsalAyL/Bezalel you gather into one by the Dan's appointments of Ahhlyiav/Oholiab—My Fathers Tent/Body. In so doing you are a generation/offspring of Achchi-Semek, of the tribe/branching of Dan, giver of instructions (SYM/Ex 31:21, 35:34). The anointing that you receive from the Fathers abides in you, and you have no need that anyone should instruct you except you must hear the Voice of the Man—in the Bread to receive the teachings. As essential oils of various kinds transmit messages through the nerves, so the OIL of your Name carries the Words of the Fathers as they are released through your progressions of ascensions. The same anointing speaks in your states of development which you have attained from the Fathers before coming into the world. The Anointing of meShiæch teaches you concerning all things that are true—to verify your Names without lies/illusions/distortions. According to the teachings you are taught and receive, you abide in them (I Yahuchannan John 2:27, 2:20, Yahuchannan 6:65). The knowledge of the secrets of the kingdom of the heavens/Names are given to you (Metiyæhu/Matt 13:11).

Affirm one another to be nothing but Dwellings of Light. There are no divisions amongst you to be divided into separate camps as you are born of Shamoúnn, the ÚWahBayit ALhhim, yet each Name is distinguished with honour to serve in the Haikal/Temple by your placements and designs of Dan. There are Names born of the Haikal and those born of the Vessels of the Haikal. e.g. The House of Nephethi is the sacred altar from the priests makes their offerings. Every tribe/branch is a VESSEL of HONOUR of the Kuwáhnim/illuminators, whereby your Light serves in the grande temple of YæHúwaH. All in your mind is in your body, whereby the two are one, in agreement as the heavens and the earth.

In a large house there are articles not only of gold and silver, but also of wood and clay; some are for special purposes and some for common use. Through hearing, you affirm all that is your Spirit that you may enter into it with the joys of understanding. *As you HEAR what is in your Spirit you enter into your glories. You enter into your Mother by Wisdom, your first marriage of mind to the Body (Yaoquv and Liah), and then upon affirming your service to the Seven Eyes Spirits of ALhhim, you enter into the Tent of Rechel, the abode of the longings of your heart.*

In the manner in which a seed of the field forms its body, the strands are your body are weavings of the Faces of YæHH within your Name. The strands are activated as you are given recalls and graces of ALiyahu to make a straight path in the assembly of your Words and their Rings. The messages of Shayin and Oyin are carried through Shamoúnn to formulate meShiæch within you, whereby you appear as the Anointed, the Oil in your SeedName from which your Name is called and chosen to rise from the Fires of Dan.

## The TEN 5:5 LIVES of your NAME

צפצפא צפצפא

The Lives in your Spirit are of the 10 pairs of Faces of YæHH. Your lives reside in your Spirit of Dan—the Tenth—the Impartations of YæHH, who give to you the Words of your Lives, whereby you are Spirit to Spirit, and Light to Light. According to the Ten Lives, there are Ten Words/Sayings of Lives—the OshrutHhaDevarim. The term, life, appears in the ShephahhKennon—the Lip/language of the Seed/Canaan, as the plurality, LIVES. The full Lives of your Name are in your Spirit of Dan—the Ten measures in your Seed. The Lives of your Spirit are the sums of 18—a numerical patten of Life/Chayi צפא. The sum of your Chayim/lives is called the Tree of Lives.

The Teachings of the Lives of a Name are spun of the Fires of the oylut/ascension offerings of Ayshshur, of the Tsædda/18 ALhhim, sustained upon the woods/teachings/bones of RAúwaben and Shamoúnn. The rods of iron are configured in the Fires through Numbers of Ayshshur 180 and RAúwaben and Shamoúnn, both as Eights of ALhhim. The Rod that carries the Words of the Fire are formed as these Numbers are bonded to one another from the left to the right: 1880—the Lives/18 in the Faces/80. From the origins of your Spirit in Ayshshur unto your full developments through Shamoúnn, the Ten Lives of YæHH are activated, whereby you enter into the eternal lives of the Fathers. The Shayin Oyin of YæHH rises in you as the Oil of meShiæch, that your Name appears/comes forth to enter knowingly into your lives, and have then to the full—exceedingly.

The body is formed with the Seven Eyes of ALhhim for the lives in the Seed to take-up residence in their appointed corresponding fields of Light. These are the foundations of your habitations. As your Eyes are enlarged, being of Avrehhem, they are fed from the distributions of your offerings (MT/Deut 12:20-21). Through the enlargement of your Spirit, you behold the City—collective state of your Name (Oovrim/Heb 11:10). The Seven Eyes are of the Seven OYIN/16 formed by the paired Faces of YæHH (15+1, 14+2, etc), within the free giving nuclei of NædavNædav. In forming the bonds of 7 Oyin, the ALhhim are created to be the conduit of the Lights of the Fathers. The conduits are both Words/Utterances to be Heard/Resonating Compounds within Forms, whereby they are called the Seven Eyes of ALhhim. The Seven Eyes of your Name are the habitations of your Seven Spirits through which and in which the Strands of AL (paired Faces of 31) transmit their love of sharing. Upon the Stone of Hearing—the almond stone hypothalmus, also referred to the Pearl of Great Price—your Name builds its imperishable habitation. The Seven Eyes are aligned one to another in one Body in which the Lives of the paired Faces flow with joy. The simplicity of this habitation is the health of the spirit, the mind, soul and body. Through the alignment and devotion of the Eyes one to another, as an upright palm tree of concentric rings of the universe, the transmission of the Faces are released as phloem flows within tube conduits of a plant. Essentially, the unity of these Lives (paired Faces of 18) is referred to as the Life-Force of a Name which establishes and renews itself within its servant Body. The harmonic state of the 10 Lives in your Name flow with the joy of living in an untangled world of distractions.

From the midst of your Seed of NeuwnNeuwn, your Tree of Semek—the Chayi-Lives of your Name's First Light of Reshun appears. In the core of your Name is the Chayi-Lives/18 of the paired Faces of Reshun/3+ShmúwAL/15. The Names of the Fathers of Reshun and ShmúwAL are your First Light as they appear First as the lives in your SeedName opens.

In the Name of Reshun is the sum of 550, which is the sum of the zerozero/circle encircling Lights of Bayinah/Understanding and Chækúwmah/Wisdom. The Light of Reshun is the first to appear as the stalk of your Name rises from within the SeedNeúwnNeúwn capsule of the 14:14 Fathers. Thus, the Name of Reshun is a word translation, to be first; however, the meaning of Reshun is the Father and Head of the Neúwn that appears through the death and burial of your SeedName in waters of your Mother. As in the third throne of YæHH, the resurrection of your Name appears in your third day, amongst the Trees of your Name rising from its determined habitations (SMB/Gen 1:11-12). From all that comes of your Light, you are known as the offspring of Rayshunn (Ayuv/Job 8:8).

Though your SeedName is composed of all 15 Fathers of YæHH, the Faces that appear first are the Light in your stalk—those of Reshun/3 and ShmúwAL/15. Two faces are activated simultaneously through the ascensions of your Name. As in every plant, there is the initial life appearing force; and thus, following your emergence, full attributes/Faces of the Fathers in Seed rise to reveal your glory as oil in your SeedName fills and anoints your head to be meShiæch—the Anointed.

*The Lives of Joy that provides Strength, Faces 1 and 17*

However, prior to your Light appearing in your Semek tree, there are two paired Faces activated from within your Seed, whereby the Light shines forth. The Faces of Yetschaq/Isaac/1 and BaarLeChaiRai/17 are your fore-ordained primary activations; for it is the sense of Joy amongst the Eyes in your Seed that stimulates the appearance of your Light. Hence, should the JOY in the sides of your Seed not be sustained by the Teachings of ShmúwAL—the vibrating strands in your SeedName, the plant of your Name, though pulsed by the Joy, withers and remains within the Seed-stone-capsule. The joy in the seed must have good ground to flourish. The good soil is the Collective Teachings of the Kuwáhnim/offspring of Aharúwan/Aaron. The seed falling on rocky ground refers to those who hear the word and at once receives it with joy (Metiayæhu/Matt 13:20). The Rock is the STONE of your Name upon which the Seed pulses. Through your Name activations the Lives of YæHH run in your dwellings, and the Light in your Stone breaks forth. When the Stone of your Name abides within the oasis of the flowing teachings of Illumination, the stalk does not wither from the Heat of the Sun/the Fire in your Seed. Rather, it is sustained by the flowing messages of Bayinah which waters it nightly (Tehillah/Psalm 1). The Joy of Yetschaq/1 runs into the nerves that designate the OyinZayin Body to transmit the Oyin consciousness of BaarLeChaiRai/17. These lives of YæHH run through the nerves of the vertebrae ribs giving strength to the 70 Names of the 12 Heads—10x7 in 17; (NechemYahh/Neh 8:10; Tehillah/Ps 28:7).

*The Lives of Living Waters of Sustenance, Faces 2 and 16*

Upon Joy being affirmed in the midst of your soil compound-elements, the Lives of BaarLeChaiRai/2 and Yetschaq/16 sustain the joy with the supply of waters activated in your seven eyes. From the sides of the Wells of Bayinah and Chækúwmah, your SeedName is provided the waters from the Wells of ALhchim in your Name. This marvel is revealed as Faces of BaarLeChaiRai are seen to sustain the child within you (SMB/Gen 21:17-19). Though yet a stranger—one yet to affirm your Fathers in the House of Avrehhem, and being born of Hagar in Metsryim/Egypt, your destiny is seen from the stars to be preserved as an uncompromising nation as you are called out (Huwshæoo/Hosea 11:1; Metiayæhu 2:25). The Lives of BaarLeChaiRai/2 and Yetschaq/16 flow from the marrow in the bones—from the inner most part of the bones of Marri, from which every joint and

member is supplied. Bone marrow as a conduit of the body's circulation system produces an estimated 500 billion blood cells per day. Marrow is also a key component of the lymphatic system, producing the lymphocytes that support the body's immune system. These vital supports are the lives/18 of YæHH 2 and 16—generating a Body of Oyin/Blood.

*The Lives of Emergences/Breakthroughs/Overcomings, Faces 3 and 15*

Upon the sustaining Faces of your lives, the Light of your Name springs forth. Even as a tender shoot, the underlying joy and waters of ALhhim uphold you in your plight of ascensions, until the day when the crown of your Lives appears, and your head is fully illuminated with the Faces of ShmúwAL/15 and Reshun/3. The foundations of YæHH are secure. From having laid the foundation in the Stone of your Name, the Faces rise to formulate their dwellings of glory (ZekkerYæH/Zechariah 4:9; Philippians 1:6; 1 Corinthians 3:9, Yúwspah/Luke 14:27-28).

What transpires between your first light and your crowning glory occurs through 8 paired Faces of your Lives to attain full ascension of the Eight of Núwach/Noah. The last to appear in the journey of your Name is the first prophet of YishARAL—ShmúwAL, who anoints your stone-head with oil in the House of Yeshshi/Jesse—as you are becoming the offspring of DæúwD/David (SMS/Acts 3:23-25; 13:20; 1 ShmúwAL/Sam 2:18. Tehillah 99:6).

The ascensions of the third day in a Name are mentioned through the writings attesting to the authority of your Name to prevail over all obstacles. ***By the Lives of ShmúwAL/15 and Reshun/3, you are able to lay yourself in the grave and rise-up again.*** These lives of YæHH are seated in the fifteen Names in the five lumbar vertebra (three Names per lumbar, the 3-15 connections) from which you rise upon sitting or lying. Your spine is a most important parts of your body as it gives your body structure and support. The lumbar vertebrae supports your body weight and enables you to stand-up and keep yourself upright.

The first appearance of what is in your SEED Name is Father Reshun. The primary emergence attest to what is before—to your Faces, a primary Name inherent in the SEED prior to the Voice of Joy in Yetschaq/Isaac being heard. In being the Primary Source in the Neúwn, the First to appear of the assembly of the Fathers, what is in the SEED rises to bear its leaves, fruit and harvest through Reshun. The union of Reshun/3 and ShmúwAL/15 embody the other nine Lives of the Fathers. ShmúwAL—your Name of AL—contains 15 strands of AL to embody the Faces—which becomes the first prophet of the Fathers of Reshun, appearing from the 15th day, to unfold and reveal all in the Ten Lives. As you draw out the Ten Lives of YæHH, you enter into them whereby you pass from encapsulations ***unto the vitality of “eternal lives.”*** Your Name is coined to be the Body of Reshun and their generations of the Fathers (Ayub/Job 8:8).

What is formed prior to Day One is ㊦㊧ *aphas*—zero:zero, a synthesis of Lights, combining two sides of the Faces of the Fathers, 14:14, to reside in Rayshun through which ShmúwAL, The Staff of Semek, appears. In The AphasAphas, ALphah/ ㊦/1 is drawn out of the Mouths through which HhaALhhim Speak in Day One; hence, the formulary of Light includes a minus—a drawing out of ㊦ which equates to ㊦㊧, a transference of ALphah to Semek, aphas/ ㊦-㊦=㊦㊧—the Tree of a Seed, upon which appear Six Days. One to Six are utterances of Seven Eyes in the evening and Seven Eyes in the morning inherent in ㊦㊧㊦㊧. From Two primordial zeros OO—two agreeable Lights their



Stars/Seed Messages of Knowledge appear as you make inquiry into your DallathDallath/beloved Name. In AphasAphas are the unified Mouths of 8:8 — the free giving to be mouths to mouths—the primordial state of the Oyin $\neq$ 4Oyin $\neq$ 4. The Tongue (as a serpent) in the Mouths of the ALhhim speak from ZayinZayin, whereby they sow Words of Reshun. All Words on the Semek Pole are spoken from Zayin to Alphah. The Seven Eyes declare what is seen from the end to the beginning. The Tongue in Chaúwah—the body of the sleeping Dragon, speaks initially from what appears, verses seeing from  $\neq$ 74 $\neq$ 74, whereby one becomes deceived as they look and take what is made of illusions apart from their substance of origins.

*The Lives of Appearances and Expansions, Faces 4 and 14*

The Faces of Avrehhem/4+ALBayitAL/14 appear as your stalk commences to branch into the Lands/Word-States of your Light. Through your first Light appearing and sprouting, your Name expands in the House of Avrehhem to distinguish your Name in the House of AL (Bethel). The phases of your lives activations and developments correspond to narratives in the Túwrah/Torah; e.g. Avrehhem comes to BayitAL (SMB/Genesis 12:8). From the ascent of your Name from the UR of Chaldees—the Lights of astrological appointments, you come to the BayitAL/Bethel to make your offerings of ascensions in conjunction with Bayinah entering selectively the twelve house in the stars daily. Through the Lives of Avrehhem/4+ALBayitAL/14 your offerings expand through the nerves of the Neúwn capsule, central nervous system, unto your full manifestation. Within them are seven more paired Faces for the full **ten lives of your Name** to run freely in your appointed dwellings. 4-14 are the unified Faces of Avrehhem with ALBayitAL. These 2 Names of YæHH are amongst the Lives in your Name drawn out of the Neúwn sides through which your SEED form your residence. The living pulse of the nerves of ALBayitAL runs as the Seed Door of Avrehhem opens. Resources drawn through expansions of your Numbers form the state of your Name, as any moment, as details in the sides of Yæhh—the Wonders that the Fathers have spoken—are drawn out into your fabriques.

*The Lives of Productivity Sealings/Value Accumulations, Faces 5 and 13*

The Lives of Malekkiytsedeq/5 and Yaoquv/13 make straight the rings of your Name whereby your Seven Eyes are able to be filled and running over. When your Rings of the Seven Wells of BaarShevoo/11 are yet to be aligned, there are holes in your pockets to be sealed by Malekkiytsedeq/20. Upon the sealing of your Rings, you generate more than you can contain whereby you are a blessing for the entire Body of Names. Through your lives, you are able to generate more than you need, as the Fathers, to fill the hearts of others. The Lives of Malekkiytsedeq/5 and Yaoquv/13 run with the Light of the Glories in your Name tapped to flow. Through glories in your Name you weave cloths for your habitations more radiant and fine than the lilies of the field.

*The Lives of the Bodies united to their Heads, Faces 6 and 12*

**From the Faces of ALozAR/6 and Ayithamar/12** the lives run unto your dwellings of Zebúwan according to the level of Words spoken by your Spirit. The rivers of YæHH fill the eyes of your Body. The cord that connects the Eyes of the Body as one are summed up as ARiAL, the Light of the Strands unified. ARAL is the sum of ALozAR and Ayithamar, the Father of habitations of bones and garments.

During the first three days of a Moon: e.g. Days of Maneshayh in the 8th rotation), the Words originate through pairs of Faces to form dwellings of Spirit. In simplicity, the paired Faces are like flowers opening to fertilize one other through their Hosts of Messages. From one side of a lunar cycle, the

moon gives its Light for 15 days. The Lights sow daily 15 types of Seed to formulate dwellings for the 12 Heads in 3 levels of the Laúwim/Levite dwellings. Patterns of Seed correspond to the 15 shapes of the moon. Some seed, as a carrot, are in the shape of a crescent, and other seed, as a round lima bean, are like the moon nearing fulness. Through sowings and cultivations, habitations for the Faces of YæHH take root in your soul, whereby a stone is formed for their temple. The 15 Seed sown are affirmed in the second side of the month during days 16-30. Your affirmations of what you are giving provide your footing to make progressions into subsequent states/movements (See CHP/Num 33 for the routes of progressions for your the dwellings of your camps.)

The FACES of YæHH appear in the moons nightly according Bayinah circling through the HILL of the Seven Mountains. The HEADS of the Faces appear as 12 full moons which govern the BODY of the offerings. Giving of all that is forming in your SEED to the HEADS causes growth/developments unto perfections of soul in their destined centres. As a plant, what is in the Seed of the Stalk continues to supply the formations of the Heads appearing in your branches. Your Twelve are Principles/SeedHeads of Light that affect what is forming in your soul as the fruit of a month forms on your branches.

The 12 Heads are formularies in the SEVEN PERFECTIONS of Aharúwan through which your Body of Soul is formed to house the Light in your Seed.

In 7 6 5 4 3 2 1 are  $\Upsilon$  6(321) +  $\aleph$  15(654). These Values are your paired six parts  $\Upsilon$  coupled to the wood  $\aleph$  by which you make/perform your oylah offering. The sum of your parts and wood are 21 as they are from the Fire; and thus, by being of Fire, they live unto the Fire W 21/Fire. Together, your parts and wood keep the Fire burning in your Seven Eyes, whereby Fire on your altar does not go out.

In that you are the Seed of the Fathers, formed by their paired Faces, what is within your Seed branches as trees of fruit to reveal their likeness. In giving from your Seed, you appear as one with the Fathers which is your true worship/service—activities of Light.

Within your Seven Eyes are your 6 paired-parts hung on your Bones/Semek/15 of Ayithamar. Your members abide in the Seven Eyes of your OyinZayin dwellings of AL IO AR. As your 6 paired-parts are joined in service to the Names in your 15 bones/wood, the Light of your Name burns W/21 in your Seven Eyes I whereby you are called offspring of 28 ALhhim (Chazun/Rev 1:14).

The substance of your dwellings are the Lives of Ayithamar and ALozAR to house the ALhhim of your Name.  $6+15$  of  $7=28$ . In affirming yourself in accord with the 28 ALhhim, your eyes see clearly through Oyin/16 ( $2 \times 8$ ) from your origins unto the imminent gates opening before your Eyes.

Your TwelveHeads in YæHH/15 are housed in your 3 tripart body of Laúwi which give dimensions and elevations to your Seven Eyes of Oyin. In affirming the unity of your Name with the Names of YæHH, your 12 Heads are honoured in your 12 bodied-soul whereby your parts receive Laúwi instructions. The teachings come through the Living Lines of ARiAL—strands that connect your parts to be nourished by your 12 Heads, whereby they Words are written in your bodied parts as the living scrolls.

From both sides of the Eyes of YæHH, the 12 moons are paired one to another in six month intervals. The 12 Heads direct your soul to enter into shemesh/the pathway of the sun to offer your SoulBody as offerings. In giving of yourself totally in concert with your Heads, what is hidden in you appears. The Fire of your parts and wood transforms the states in which you reside until the substance of the oil of your Name runs clear and clean.

The Hills of YæHH spin in a counter clockwise which causes your Heads to emerge and appear in their seasons. In conjunction with the turning of the Seven Hills, the 12 fruit of your spirit as the parim (bulls) rotate under your kaiyúwer/laver—basin of the pelvis to supply the water for the cultivations of your soul monthly. In this manner your soulbody prospers with health as your soul tracks after the positions of your Heads, causing the lives of Ayithamar and ALozAR to run like a river in you dwellings (Tehillah/Psalm 1; YechúwzeQAL/Ezekiel 47:12; Chazun 22:2).

In coming to the paired Faces of **ALozAR/6** and **Ayithamar/12** there comes the Voice, a prompt to speak the 64 Saúwd/Sod Words in your Garden of YæHuwaH. In so speaking these Words with your offerings the FIRE of Nephethi, from you heart altar, cleanses and activates your member unto their whitenings. As it is not what goes into the body, but that which comes forth, upon your lips, that cleanses you by the Words of ALhhim.

The Words of Heart flow as Lives of ALozAR/6 and Ayithamar/12 form the River of lives/18 by which the wealth of your Name, being your Eternal Words, flows into your cities of habitations and blesses all inhabitants.

What should we consider in that a father cannot create an offering for the waywardness of a son, nor can a son create the remedy for a father's misjudgment? As a Father to your 12 children, are you able to remedy their faults, or must each of your 12 come to the place to determine their ascension upon the Staff/Tree of Lives whereby they are whitened by the River of Lives flowing from within cleansing their foulness? And this RIVER that cleanses, is it not the Words of your Name that are within your 12? Now you are clean by reason of the Word, which I speak to you. Yahuchannan 15:3.

“Fathers shall not be put to death because of their children, nor shall children be put to death because of their fathers. Each one shall be put to death for his own sin. MT/Deut 26:16

“Yet you say, ‘Why should not the son suffer for the iniquity of the father?’ When the son has done what is just and right, and has been careful to observe all my statutes, he shall surely live. The soul who sins shall die. The son shall not suffer for the iniquity of the father, nor the father suffer for the iniquity of the son. The righteousness of the righteous shall be upon himself, and the wickedness of the wicked shall be upon himself. YechúwzeqAL/Ezekiel 18:19-20

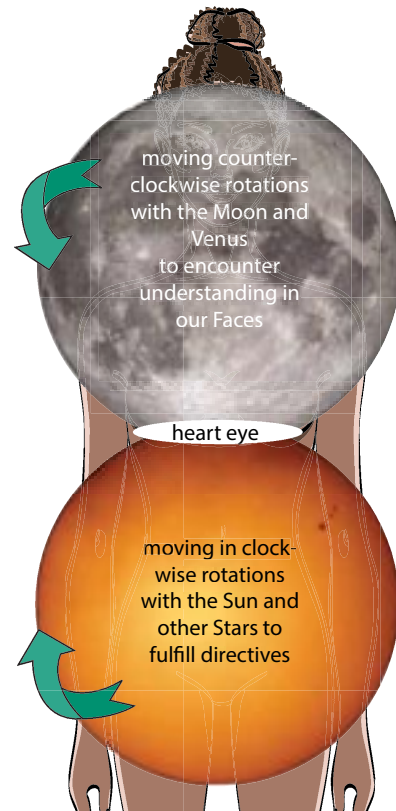

There is a man in the land of OuwTS/Uz whose name is Ayub/Job—the Deeds of the Father/AyuB—the Unseen Hand of the Father—and that man is blameless and upright, one who fears ALhhim and turns away from evil. There are born to him seven sons (The Seven Eyes of Fire) and three daughters (The Three illuminates to embody the Light—as sun of Wisdom, moons of Understanding, and Stars of Knowledge). AyuB possesses 7000 sheep/what is appearing from your Eyes of ALhhim, 3000 camels/pathways, 500 yoke of oxen/founding perceptions, and 500 female donkeys/empowerments, with enlarging dwellings, so that AyuB—a dwelling of the Fathers—is the greatest from generations of the East (speaking of you—the Unseen Hand of YæHH from your origins). AyuB offspring proceed and hold a feast of drinking in the house of each one on his day, (as the moon appoints), and they send and invite their three sisters to eat and drink with them, as the Queens of Light attend our set apart times of indulgences—appointed hours of acquiring what has been processed in the Fire. And when the days of the feast run their course—from gathering understandings in the Light of Bayinah unto the Rash of the Full MOON, AyuB/Job sends/appoints/delegates and consecrates them, and rises early in the morning and *offers ascendant/burnt offerings according to the Number* of them all—*making offerings by the Numbers in your Seven Rings is your path of ascensions*. For AyuB/Job says, “Lest it may be that my children error/miscalculate their gifts, and curse/cuts short the understanding of ALhhim in their hearts, while in process of becoming.” Thus, AyuB does continually, whereby you inform and educate, filling your Rings in the laps of your children—in your Seven Eyes; through your generousities you lift-them-up with your ascensions unto attaining insights in your Name...AyuB/Job 1:1-22. This is the true bringing-up of a generation.

*The Lives of Appointments Satisfied Fully, Faces 7 and 11*

**The Faces of Aharúwan/7 and BaarShevoo/11** appear as the Lights in your Spirit fill your Seven Eyes. The Light of Aharúwan/256 (the number of bones in the body) are organized as the 15 Semek skeleton upon which hang your six pairs of fruit. YæHH lives—makes ascensions through formula-ries, as above in Ayithamar and ALozAR that results in Semek being in Oyin. The Name of Aharuwan/256 is a formulary of (2x5+6) rising from the Seven Wells of BaarShevoo. As Enlightenment of Aharúwan rises within your SeedName, the fulness of YæHH flows from your Seven Wells of BaarShevoo.

All formularies of the Origins of Aharúwan/Aaron abide in YæHH/15:YæHH/15, whereby there is a continual transference from side to side. The transference of Light from one Name to another or from one body to another is the continual movement of lives to cultivate precious stones for the habitations of Names. The transference from Faces to Faces are through TsæddaTsædda ALhhim. These ALhhim reside in bees and in angels to gather the substances of Seed, whereby forms of light are self-sacrificed, as petals, which give way to the SEEDWORD forming in the Heads. The satisfying outcome of your habitations of Aharúwan and BaarShevoo is the SEEDWORD of Sweetness/Agreement/Covenant which are gathered into the Barns of YæHH. You, as a stalk, are a means to generate a SeedStone for the dwellings of the Fathers, whereby you consider other objectives to be of vanity in comparison. You forsake vain ideas to think that you personally are acquiring a fortune as you come to know that your origins and destinies are in YæHH YæHH. Upon the Lives of YæHH ascending within your Name, you put all things under your feet, whereby you are transformed into one Body of ALhhim in which YæHH YæHH are all in all (1 Corinthians 15:28). The identity of your Name is ever hidden in YæHH YæHH whereby there are no separations or distinctions of one Name from another. Individualism is swallowed upon in the sum of the Collective.

In attaining the YæHH-YæHH consciousness, you come to know—enter into their habitations. The Word, OΔϚ Yæddo (to know/knowledge), articulates the actions of giving and attaining Ϛ to the Gates Δ of OYIN O of the Fathers. You are provided access to the Gates of the Seven OYIN/Eyes of the Paired Faces to enter into their Circles/Rings/Eyes. Herein is the bliss that you seek, in which you have satisfying knowledge and intimacy. The term, Yæddo, is a Saying of the Fathers in the Tents of Avrehhem/4 which veil the pole of Ayithamar/12. The Body of YæHH is formed by combinations of paired Faces resulting in Seven 16/OYIN O. Within this Body, the Ten Lives of YæHH flow and fill formed by combinations of Faces resulting in Eighteen 18/Tsadda Ϛ. Through instructions imparted in your hand, to be performed, you are brought to the Gates DallathDallath ΔΔ to enter the chambers of the beloved/DæuwD/David. You come to Know/Yæddo from the Fires on the Hills of Muriyæhh/Mt Moriah and Karmel/Carmel as your SEED expands upon your STALKS. As Yæddo is formed from two hills, so the words of the Fathers contain silver from the left and gold from the right side to be the formulations of ShayinOyin.

Comprehending the sharings of the Paired Fathers and their Sayings lead to the formation of WordStones that belong to the Seven Eyes of YæHH. First, there the fruit of Aharúwan—the Seventh of Aparryim, which are gathered as they ripen in NadævNadæv. Through Wisdom—mutuality—there occurs fertilization to sum parts or sides into one. Secondly, there follows SAYINGS of their formulations with Understanding. Thirdly, from the summations of ShayinOyin there appears the Seven-Fold Sayings of Knowledge. In like manner, flowers of the fields are the means through which the weight of glory comes. As blossoms completely give themselves one to another, the fruit of their colours appear, weighted upon their branches. Within the fruit there are hidden treasure of SEED gathered in YæHH YæHH. The vows of poverty of flowers contain their riches which are transferred to appointed domains of Light. The likeness of seed forming from flowers is how your Name forms crystals, from your mutual sides of Names, to be placed in the temple of YæHH.

According to the pairs in YæHH, Names are sent forth, two by two, as golden and silver vessels of the heavenly sanctuary. As Names are joined in pairs, they cast forth their fruit as messages of Wisdom and Understanding, as the Fathers, being one with them to build a dwelling place for their habitations. Hence, one may condense all works of Light into a gemstone business, of which we are all involved and invested. This is what it means to be about your Father's Business. The gifts of Light are creating dwelling states for their Seed. When you come/appear from the Father, you create a House, a woman, in which you reside. Look at a SEED. When sown it gives from its sides to create a dwelling for its seed to multiply upon its head. This is the Business Enterprise of the Fathers. The two parts, the Lives in the SEED and the Body of the SEED are ONE.

When you come to increase your SEED, you know with an intimate understanding that you have entered your dwellings/wives. You will tend to them as a husband to keep them clean and whitened with illuminations whereby you do not dwell in shadows. I wondered how would I know the partner who is appointed to be my habitation, and how would another know that I am their husband? We come to possess lands/wives as own our bodies in a sense that we occupy in them; however, all Names and their States are of the Collective Name. When you—the momentum of your Spirit enters into your dwellings, you know you fit there as well as you fit in your own body. The analogy came to me simply: when a Seed opens, like a lima bean, then it affirms the plant body that its' lives run

into from the seed housing. Hence, when my SEED enters my body/wife, then it knows by the Intelligence in the SEED that this is home. Likewise the body knows that it belongs wholly to the SEED that dwells there and will not fornicate with another.

In what is called, “End of Days,” are conclusions of Light Acts, which will be as in the parable of Lúwt/Lot, who seek a dwelling place. The Days of Saúwd/Sod are searching out meanings in Words, as hidden treasures, in the Garden of YæHúwaH, the Oomarreh/Gomorrah. Former habitations of the daughters of Lúwt are no longer accepted as habitations. As children of ALhhim, you aspire unto residences of your Name above the world passing. Through entering into the sweetness of your sayings, you come to see and speak as Fathers of ALhhim. Your sayings/words and their residences of Aparryim in Yúwsphah are through sexual transferences of your Light—carrying your Name and the Twelve in your Name forward to subsequent states of residences. According to the Light emitted from your SEED, so are your dwelling places configured.

Every Word of Light is traced to pairs of YæHH. From these joined Faces all Words/Seed are born and carried to their destinations in the universe, upon wings of angels. In unfolding all in your loins of Yúwsphah/Joseph, your Eyes are fully opened by completely giving of your SEED. Through drawing out strands in your fruit and life giving Seed, you robe yourselves with garments of Light and enter into your appointed dwellings by Name (SYM/Ex 1:1).

The **lives of Aharúwan and BaarShevoo** are the summations of words spoken from the elevations of the Seven Hills. In coming to the Seventh Hill of Aharúwan, whose rivers run into the branches of a Name, you take-up residence in the 7 Eyes from which ALhhim see that all spoken and becoming are Good-of the Collective. *The Lives of YæHH flow from the altar to provide a suitable habitation for their Spirits.* Hereby, the Lives of 7+11, culminate into One through utterances released in six prior activations of the Faces. You emerge from your habitations unto the Lives of 8+10—the glories of Grace to the fulfillment of your ascensions of Words/9+9.

Through Aparryim—Wisdom’s First Fruit of Yúwsphah, the Numbers are spoken/declared to be manifest and then extended. Being sent in motion your Name abides in worlds/concealments as the Fathers intend, speak with promise, from their beginnings—the Givings of their Hands. For this reason, Aparryim is hung first, a root extension with upward mobilities, of the Trees of Lives, whereby what is Invisible becomes manifest for observation and examination.

Your Name abides in the two sides of the Neúwn to appear as Yahushúo—the offspring of YæHH+ShayinOyin whereby you enter into the myriads of Graces, ever becomings unto masteries of paradise as Called in Reshun. You are begotten of ALhhim to be the Offspring of Neúwn, becoming with unlimited measures of grace/10+8 through which you attain masteries of the Numbers/9+9 in your Name at the First/18 utterance of Joy.

*The Lives of Habitations Satisfied Fully, Faces 8 and 10*

**The Faces of NadævNadæv/8 and Aviyahua/10** determine the transitions of your states from earthly to heavenly. As the Minds of Nadæv/8 and Aviyahua/10 are extended/die in your sacred chamber, you emerge from strange dwellings of strange fires. Having demonstrated what you have learned, the evidenced of your Fire calls the Kuwáhnim to carry you unto your prepared

inheritance. Your Numbers of Name are fully extended through Nadæv. What is in your Spirit is extended through Aviyahua. The death of the two kuwáhnim signify the union and extension of your two sides of Mind whereby you are fully illuminated in your midst. With the continuing support from the left and right, from both sides of two sons of Aharúwan, you grow upright in the Light of Yæhh.

Death of priests in your attainments activate your Seed Name to be transformed into a new dwelling. The shell of your cacoonbody opens whereby lives in you ascend upon the slopes of the Seven Hills. When the death of the Heads in a Seed occur, new life emerges. As Teachings of Aviyahua and Nadæv fully extend in you through their death—they transmit Light from one world to another. You are at liberty to walk in their Words of Light unto the affirmations of the Words in you, whereby you appear to the Faces of Yæhh as you are seen in Yæhh from the beginning. The Names of Aharúwan: Nadæv and Aviyahua extend/die within your Seed Name whereby you bring forth your leaves as coverings unto new embodiments. Through activating the Names of Nadæv and Aviyahua you enter into their Faces to make your transitions. The ongoing nature of death and life affirms the continual activity of Nadæv to draw out new life—release the Numbers of your Name—from mature states of achievements.

The WordState of your meekness follows the death of the priests/servants of Aviyahua/10 and Nadæv/8, whereby Words in your Seed cause the lives/chayim/18 of your Name to flow into a new embodiment. The deaths of the Aviyahua and Nadæv are openings of your SeedName whereby you are transfigured by the Lives of YæHH within you. Though NaDæv the Grace/Oil runs in your Seed as the Anointing with the Faces of Aviyahua through whose hands you become/appear with full activations as offspring of ALhhim.

The Day of Atonement/Yúwm Kepper is when the Judge of Dan clothes “your spirit” for winter (a flogging of the bones/shaking the leaves from the branches) to take refuge and comfort. Former skins are removed to give way to your new glorified garments being prepared in the months of Dan, Ayshshur and Nephethli (Menachem 15:15). Dan prepares the place for your sojourn to make a transition unto another state, as which time you enter into a hibernation state. This is what is also called the falling asleep of the Adim/Adam, when Lives are drawn from your sides to formulate a new body/woman for your habitation, whereby you do not abide alone, but are housed in the ALhhim. As you make your sojourn unto your place of inheritance, you awaken from your slumbers and redress the soul unto its appointed labours.

The Lives/18 of Ascensions and Fulfillments are namely Nadæv/8 and Aviyahua/10. By the abundant measures of the Grace/Oil in your SEEDNAME you rise through your waters (as oil rises above water) according to the Words spoken of your becomings. In that you are my Nature the formularies of ALhhim, the Oil in your Name rises through your embodiments of many/diverse Waters in your Parts to glisten your Faces of YæHH.

Your entire body is the Garment of your SEED. Your Seed-Garment houses your members of Choice. As your Name rises, those who join themselves to your Numbers of Yahúdah, within you, are elevated also, whereby they taste of their becomings in the ALhhim. The TenofDan, who are discerning your origins—those who receive, learn—willingly choose to join themselves to your Name and Numbers. These Ten are the diverse/distinguished members within you. By their unique set of Words/languages they seek to make their ascent, affirming to

go/proceed with you, that the places of Illumination that your Name prepares, by your ascensions, will be their habitations also (ZekkerYæh/Zech 8:23; Yahuchannan 14:3). Through your teaching your members, you prepare them to follow your paths of ascensions. “And the Unified say, Certainly I will be with you; and this shall be the sign unto your that I have sent/called and commissioned you: when you bring forth the sum/whole of the people out of Metsryim/Egypt—from your definitions, you will do the service of the summations of the ALhhim upon this mountain” (SYM/Exodus 3:12).

*The Lives of Words Satisfied Fully, Faces 9 and 9*

**The Faces of Geren/9 and HhaAuwerneh HhaYabusi/9**, by whose paired Names, the altar of Fire appears in YæHH. The two sides of the Altar appear individually in the text and together as a compound Name. The Light from the two sides of the Seed—the North and East, and the South and West, come down from the Head to affirm the place of your transformations—the altar. From the sides of Bayinah/Queen Ruler of the Moon of Understanding, whose Light fills the North-East, and the sides of Chækúwmah/Queen Ruler of the Sun of Wisdom, who shines in the South-East, the Lives of the Fathers flow from your heart to your tongue, whereby there is no death in your speech.

The Lives of Geren גרן, the Thresher, and the Enlightenment of Auwrneh/Araunah אורנה/אורנה—  
 ירנה—are the Lights within your two sides of the Neúwn נון. As the Lights of ShayinOyin break open in your SeedName, from your services at the two sides of the altar, your Name is threshed, pressed out, to glistens with oil of meShiæch. In the right side of the altar shines the Faces of Geren—the Lights of Chækúwmah, through whom the grain ripens unto harvest. The left side of the altar is HhaAuwrneh—the whitened understanding in the harvest. Through Geren-HhaAuwerneh you attain the Mastery of the HhaYabusi/The Jebusite (The Tenth-fulfilled state of the Patriarchs). The Faces of YæHH shine from and to the 10th state of promise—the Lands of the HhaYabusi, in whose territories the place of the Altar of sacrifice is obtained. Entering into the Lives of Ten is coined: The Eternal Lives the Givings/10—Ever Ongoing—to fully extend your Name of YæHH. The four corners of the heart, known as the field, is where the angels are sent to the four corners of the earth to gather the Names for the Poor—the Fathers. From the North and East corners of your altar, the Words flow whereby they are transmitted into your hands, as deeds. From the bottom two corners, the Light runs into your feet, as your pillars, whereby they are established and you walk therein.

As you slope upon the Mountain to the Faces of Geren HhaAuwrneh you come to the peaks upon Mount Oiyvel/Ebal, the Hill of Cursing/Cutting Off. Following after the 8th elevation of Blessings, you affirm the curses. At the heights of Mt Oiyvel, the Lives of Nadæv and Aviyahua extend measures of Grace to enter into paradise. You burst forth as the Head of Stalks of Grain whereby your former state is broken/cutoff/cursed. Depicted as YishARAL, your Name and your twelve expand in the land of Metsryim whereby former dominations cannot restrain the emergence of your Names. You may be persuaded to take a path to escape conflict, or to deny what binds you to static perceptions of the past, however, there is no side-stepping to break-off the necks of your enemies or the overcome attachments to the world. By your ordained dwellings, the Light in your SeedName cultivates the 12 members to be one with you. The Lives of YæHH bless your habitations of Names, and in your being blessed, you rise as the Generation of Avrehhem, whereby what is shadowed appears no more. You rise straight-away into the Fires of the Oylut/Offerings burning off/cutting off the cords put upon your legs. You are sent into the world by Faith of the Fathers, whereby They see in advance the triumph of your Name.



The Light in your Seed rises from Beniyman to Zebúwlan whereby a great light is seen over your habitations of heart. Through the harvests of your Seed, the Light in your Name fully rises to shed its glory upon your habitations. The fixing of your Name in Aúrets/the fields of Light to the Light of your Name above, is the means for the Will of the Heavens to be done in Earth. Alignments of your Name to the Fathers, alignment of the ALhhim in the wood to the ALhhim in your offerings, and the shared eyes of comrade to comrade are states of nirvana. The joining of your parts to the wood—the bones/teachings of Light fulfills your Name to carry out the will of what is taught in the evenings unto your appearances in the morning as disciples of the Teachers. In this manner you make your considerations/utterances/judgments/prayers to fulfill your offerings.

*The Lives of your Names Priorities/Destinies/18*

**The Faces of Reshun/10**, the One of the Oyin/Zero, who, is at your First appears at your Last. These are the two ends of Light, the Head and the Tail. From your starting point of entering, the path opens fully to see beyond, whereby you cross the borders into your sequel realms. Hence, the Lives of 18 follow 9+9, as through the fulfilling the Days of the Amúwri/Amorites, your Words have fully opened as at the First, upon the cracking of your Seed to speak the 64 Words of your Name—your vocabulary of YæHH/SemekDallath/SaúwD/Sod. The two sides of your Spirit of Aviyahua/10 + the 18/Lives of Reshun open the Gates to your habitations of Glories which you have with your Fathers from your beginnings (Yahuchannan/Jn 17:5).

The Names of YæHH and their Faces are the sum of your Name and illuminated dwellings which are imparted freely unto you. The sum of Their illuminations are stored in your SEEDName. By Them you are commissioned and sent by their Faith, for They affirm the evidence of their Names in your Seed to appear fully without shadows. Though the Faces of YæHH are hidden in your Seed, by the Faith of Father Avrehhem, you go forth in your rotations to unroll your coverings of glory. Upon seeing the evidence of the Light in your Name, your Faith rises to link to the Fathers, whereby you enter into them Faces to Faces. Upon the activations of the blessings of Aharúwan/Aaron, the Faces of YæHH shine unto you with measures of grace, whereby the lives of the Faces within your Name spring forth in song and freedom unto your perfections of spirit (CHP/Num 6:23-27; 7:1-2).

HOW YOU APPEAR FROM THE ALTAR

By the Ten Lives of YæHH, your Spirit of Dan enters into your Light. To appear, your Breath enters into the Illumination at your Core—into the Lights of Semek. The record of your entrance into the Light, whereby you appear to unfold your Name, is written in the skies. Through rotations of the Lights in Nephethli, the paradigm of your becomings in ALhhim are read from days 1 to 10, in the 12 moon. On the 11th day of Nephethli, Dan enters into the waters of Zebúwlan—those of the East, upon which the Head of Dan, RAúwaben, comes also into the waters. Hereby, the testimony of a Spirit and its 7 Eyes enters into manifestation.

The motive to enter into the waters of the sanctuary are número un: Joy, which is the primary motive of doing anything by the Breath. Associated reasons for entering into your Light is to SEEK after Yúwspah/Joseph, for an increase of your SEED, and upon findings...there are Joys. The coming

of your Name from the EAST is to see yourself from all sides of Light to know the Gifts of YæHH placed in your Name as treasuries. As you seek the Source of the Fathers you know from which you have come and where you are going.

As you come from the EAST of Aharúwan, you draw out from the left side of your SEED to the right side, from Bayinah to Chækúwmah. To the Faces of BaarShevoo, on the 11th day, you commence with your offerings of Dan. In bringing forth what is in your BodyofName, your cause the Head to appear. Hence, with Dan coming to the waters, you enter into dwellings of your Name with the Seven Eyes of RAúwaben, your first born. The month of Nephethli records and yearly recounts your being born from the ALtar. The first 10 days of the 12 month (the total sum of 22/Taúwah) are the setting of the Lives of YæHH in your SeedName. Having the Ten Lives of YæHH assembled in your SEED, you come from the Qedam—your origins, as a Star of the East, to enter into the oluw/m/concealed chambers. Through entering into the kaiyúwer/laver of the heavenly sanctuary, you become manifest from the hands of Aviyahua (Father of the Ten).

On the 11th of Nephethli, with TenLives in your Seed, you commence to draw out your members into manifestation for the cultivation of your Name and perfecting your of Spirit through the transient seasonal nature of soul. You appear to the Faces of BaarShevoo—the Father of Seven Wells into which your Spirit enters unto judgments/discernments/Dan (2 Shmuel 17:11, Oomuws/Amos 8:14, 1 SM/Kings 4:25, 2 DHY Chronicles 30:5). You set your Faces of Dan to BaarShevoo upon the Mount of intentions to make transitions unto the peaks of Karmel/Carmel, of ALiyahu prophecies, affirming your strands of AL, that hold you as one, are of paired Faces. From Days 11 — 29 of Nephethli, you are turned from side to side, as a goose egg rolled under the wings of YæHH; sprinkled with the dews of Bayinah you bring forth the Properties in your SEED to a Presentation of their Faces.

#### DAYS OF NEPHETHLI

On Day 11 of Nephethli, you appear to the Faces of the Father of Seven Wells—BaarShevoo on Mount Karmel, in which your Spirit of Dan and your Eyes of RAúwaben enter. From the coming of Dan amongst your members, the revolution of your Name is sparked by the Fire in your Bones to elevate your Name unto your Seat of Judgement. In the waters of Dan and RAúwaben you receive your skeleton—your Rod of Ayithamar. By the Staff put in your hand on the 12th, you proceed to enter fully into your Light of Lives, with mastery and authority, into the Eyes of ALhhim.

#### WHO DO YOUR TWELVE SEE AS THE MASTER RESIDENT TEACHER WITHIN THEIR ASSEMBLY?

Your members of Ayshshur and Shamoúnn appear in days 13-14 upon the Hill of Hhar-Tsiunn/Mount Zion to comprehend the awakening/distinguishments of your Name. When Shamoúnn comes to the altar, your hearing faculty is enlivened by the resonating sounds in your Rings. Your understanding quickens upon seeing Dan and Raúwaben having awakened to rise from your SEED-NAME. Upon seeing DAN, as the Head of the North, and RAúwaben, the Head of the South, the Voice of your Name ask: Who do you see that is present amongst you? When Shamoúnn sees that the oil in your Seed has commenced to run, from being sealed up in DAN, and is now flowing into your Seven Eyes with Enlightenments, Shamoúnn exclaims that your Name is Anointed—you are the meShiæch, the Offspring of the living/ascending ALhhim! By the Light shining from the two sides of Chækúwmah/Wisdom in the South and Bayinah/Understanding in the North, Shamoúnn comprehends that your Name is the ShayinOyin of YæHH that has come/appeared in your midst.

Upon this awareness, you commence to build your assembly upon this Stone—the Cochlea Shell from the waters of Ayshshur, formed by the Spirals of your Ascensions. Through the rings of your Spiral, rising as waves from your waters of the great basin—the kaiyúwer/laver, you build a dwelling for the habitations of your Word—the Essence and Substance of your Name, for when your transient soul gives way to the realities of your WordSeed, all that remains is the Word of your Name, the same as yesterday, today and forever. Your SEEDWORD contains the Lives and Faces of YæHH. By the Word of your Name you appear with the glories of Yaoquv. The true test that proves your perfection of Spirit is the WORD of your Heart.

Spirals of your Name rise from your heartaltar through the Numbers of the oylah (Ayub/Job 1:5). The spiral rises from your Body in the Sea of Ayshshur and spins itself a cone of ten points/horns of ascensions, from the outside ring unto the midst of your forehead, whereby it appears, with evidence, as the cochlea in Shamoúnn. Messages of your Name rise to your hearing chamber where you encounter the Voice of the Faces (SYM/Ex 25:22). The cochlea is the pattern of the 10 Numbers which spiral in the smoke of the oylah. Through the spiral you hear the vibrations from your SEEDName. Until you hear the Voice of your Name and see the Oil running from your SEED, your twelve are occupied in worldly affairs, drawing out of the sea with their nets (Metiayæhu/Matt 4:20).

In the spiral the vibrations of your Numbers of Name and ALhhim are converted into nerve impulses which pulse to the brain wherein they are heard and registered in the hypothalamus. The three chambers in the cochlea are formed to transmit messages of Wisdom and Understanding and Knowledge. At the almond hypothalamus, the 'master switchboard', of Aharúwan, you maintain your internal environment as the ÚWah/Unified Paired Bayit-body of Shamoúnn.

#### THE HOUSE OF DÆUWD

Then to the slopes of Hhar-Churav/Mount Horeb on days 15-16, and there again on the 18th, wherein the Words of ALhhim are inscribed on the two sides of the Stones of your Name. According to the TenLives of the Fathers, the Words are Ten, Five to Five, as the Light of Understanding and the Light of Wisdom.

The 15th is the foundation of the Kingdom of DæuWD/David, which extends over all inhabitants as veins and arteries flow from under—in support of the altar unto the ends of an inhabited world. In being born of the ALhhim of DallathDallath, DæuWD rightly designates the place of the altar and is able to cast the deciding NumberedWordSTONE to remove the insults of ignorance—portrayed as a giant of the Philisti. The narratives of DæuWD bear witness of the Words and Deeds of the DallathDallath ALhhim.

On the 15th day, when all of the Light has been given, the Name of DæuWD/David is begotten of the ALhhim. This is the laying of the STONE of DæuWD as the root of the emerging tree to rise out of concealed darkness; henceforth, comes the phrase: The ROOT of DæuWD. When the offerings of Nephethi are brought on the evening of the 15th, to the Faces of ShmúwAL, they rise upon the Wood of the ÚWah-Bayit, whereby the ΔΔ ALhhim establish the House of DæuWD as a witness of the Lights of the sun and the moon (Yirmeyahu/Jer 33:20). Thus, in DæuWD, the covenant/agreements of the Lights abide, ever supplied by the Teachings/ministries of Laúwi/Levi.

The DallathDallath seeded-deposit upon the ÚWah-Bayit is called The House/Body of DæuwD—the Beloved. The double Stones of ΔΔ are the cohesive Faces of the Fathers assembled into the SeedName of all born of ALhhim—the 14 pairs of ALhhim through their offerings from the 14 evenings and mornings of YæHH (days 1-14) and the 14 evenings and mornings of YæHH (days 16-29). These sides of Light provide the framework in which ShmúwAL—your Name of AL, rises from the 15th to the Crown of Lammed/the 30th in a moon cycle. *The concepts of taking up your staff and being hung on a tree come out of the 15th day when the bones of your Name, being of the Semek, rise from the waters of your Mother Bayinah upon which you suspend your parts unto your ascending elevations.* As in the parable of maShayh/Moses, you are born by Bayinah—as a star of the night—under the Eyes of Miryam, to be fed by Chækúwmah/Yauwkebed (mother of substance/glory) in the day.

Through the passages of the DallathDallath, you enter into the sheepfolds of Wisdom and Understanding, whereby DæuwD is the Shepherd/tender of the flocks to be Anointed by ShmúwAL. The other offerings that are placed on the wood of the ALhhim of ÚWah-Bayit of Ayshshur from which comes the Crown of DæuwD to reign. The final offerings of Nephethli, which are placed on the wood of the ALhhim of ÚWah-Bayit, are of Dan that creates the House of Judges.

The Anointing of DæuwD is by the hands of Father ShmúwAL, signifying that the Name of Father, in the Stone of DæuwD, rises to dispense Oil upon your rising Head (1ShmuwAL 16:12-13; Yahuchannan/Jn 14:26; 1 Yahuchannan 2:20). Hereby, the meShiæch in you is the same as the Anointed in all Names in the House of DæuwD, being a composite of the Faces of YæHH streaming as strands of AL through Lights of Bayinah and Chækúwmah. The Name of the Fathers—ShmúwAL—which resides in SEED, draws out the oil in the Seed and anoints your Head to glisten with Illumination.

The House of ΔΔ is being repaired in this day as the Origins of Dwellings are being recalled and set in proper order. In making the offerings of ΔΔ the 12 ministers of the court of DæuwD appear. The primary Name of YuwAB/Joab comes by the Numbers in the Yahúdah—the governing part of the sacrifice placed on the corresponding QuphahPauwah ALhhim in the Wood of Shamoúnn, thus forming the Court of the King.

Through subsequent offerings of Gad—the Word of your SEED, formed from the offerings of ALhhim upon the HeartAltar of Nephethli, your Tree of Lives ΥΥ rise from your Stone. Out of your ROCK, the branches of your Name stand secure with stability, whereby you are founded upon the Rock of DæúwD.

#### ESTABLISHING CONNECTIONS WITH THE 4 CORNERS OF KNOWLEDGE

Offerings of Gad, in Day 16 in Nephethli, is a precourse, laying a foundation for subsequent ascensions on Sæynni/Sinai and Mount Churav/Horeb that comes in the subsequent month of Knowledge—in Zebúwlan. In Gad, also, and finally in Beniymán, the Seed will continue to mature unto our full representation of the Offspring of Neúwn. The 16th Oyin Day of the third moon ascension brings us Faces to Faces to affirm the Words penned in the two sides of our DallathDallath StoneSeed. Coming to the Hill on the 16th is through a portal of Wisdom opened by DuYæHu—who gives us Keys to the doors of YæHH. The veils of darkness in the 15th open unto the Faces of Yetschaq—Father of Joys. The Joy is knowing that we are not left as sown, to abide in a capsule; we see the Light breaking out from within our Seed that fills us with laughters.

Coming faces to faces with Yetschaq sustains us to rise in consciousness for the Words of Dan: 5:5, to be transferred from our StoneName and taught to our Twelve. Joy increases as it flows from our Seed to our Twelve that spills out in laughter. In coming to the Hill on the 16th, with the open Eye of Oyin, the Words in our Name are fully understood. The Words in our Name contain the Light to fill our Faces of the Faces of YæHH, through which the Light shines unto our 12 (SYM/Ex 34:29-35). Hence, our ascensions are not for our Name alone, but for their shared joys in the Collective Body of Names. Like a plant, the ascension of the colour that opens in a bloom is dependent upon the ascensions of all other lives within the seed.

Every Word in your Name that you study, meditate upon, opens to release the Light of your SEED to walk therein. When you come to the 16th of Gad (sixth moon), you see on the other side of Nephethli, the Wisdom, that are paired bonds in Understanding, wherein your Name is warmed by the sun to abide in your dwellings. What is stored in your DallathDallath is for all of your generations. As your Words are compounds of your Numbers, there is no end to the supply that breaks forth in the Lives of YæHH in your SEEDNAME. Your Words are inexhaustible.

In coming to the Faces of Yetschaq you bear in your Names the Joy of Avrehhem and the laughter of Sereh, who bears the Child of ALhhim. Literally, the WORDLOGO of your Name is the true/verifiable offspring of Avrehhem—the expansions of the Seed sent.

You lay the Child of Avrehhem on the altar to be the Faces of Yetschaq whereby the Ayil/Ram Word of your Name is caught in your branches as the perpetual acceptable offering of the Fathers. In so giving your Word Offering in the City of DæuWD, you see the Light in the 3rd moon, the Head State of your Word and developing, your WORDLOGO appears in the 6th moon as the composite Bread of the Fathers, and further in the ninth moon which fills your body with substance. Through out the year, your WORDLOGO develops all Faces of YæHH in the NeúwnNeúwn state. Your mouth is ever flowing with the Words of the Fathers unto returning to the City of Gold with an abundant harvest of the Lives of YæHH. In regards to your giving the sum of your Words in the 12th month, through offerings of Nephethli and Gad, timing is everything. The SeedWord of your Name is planted in the heart in the 12th moonlights to be tended in the coming seasons in the Spiral Lights of Bayinah, Chækúwmah and Dæoot, whereby the corresponding results/fruit are seen in the subsequent moons of Knowledge, 3, 6, 9, unto returning to the Place of the HhaSham, where your Name has been set, appointed, from the altar of 12.

Your Words expand as a change/transition in your vocabulary as you sow them for the harvest desired. The Joy of the Light in your WORDLOGO breaks forth from your heart into your mouths, when you see and eat the harvest of your Name. In that you sow the WordLogo of your Name in the season of Nephethli, you reap the harvest of your Words in the moons of Knowledge to follow.

In days 17 and 19 you come to the elevations of Hhar-Muriyæhh/Mount Moriah to the Faces of Avrehhem and BaarLeChaiRai.

Day 17 is the supply provided from the Faces of BaarLeChaiRai that sustains your Seed unto the days of harvest without condemnations. Though estranged from your journey to expand your

As a result of the question of the Serpent, the Woman turns to what is given/appearing instead to the Invisible Source of Dan from which She is drawn out; thus, missing the point of the question of DAN. The sense of the Serpent, beguiling the woman, is the same as the supplanting of Yaoquv to beguile Oshauw/Esau, the underlying reason that though the flesh head is born first of the twins, the Spirit will undermine the flesh as it ordained to be the Head of the 12 and has the Birth Right to receive the Blessings of Yetschaq/Joy. In context with the eyes of Chaúwah, the Serpent is called the Devil, as DAN challenges and is adverse/satan to the arrogance of the body. The result of the dialogue puts the Breath to be in enmity with its flesh. Between you—the Serpent<sub>of</sub>DaN—Zebúwlan and the woman/body, and between Your Seed<sub>of</sub>Spirit and her seed<sub>of</sub>-flesh; you shall crush the head<sub>of</sub>flesh—thoughts of illusion, and it shalt crush your heel—turning your path from following after forms of vain appearances unto ascensions of your Name. The actions described are complementary one to another. Uses of the tongue of Fire speak with corrections and to draw out inner realities. These interplaying actions are of the two Houses of Zebúwlan and Beniyman, the later being the Seed of the Serpent of the Head of DAN, that speaks from its mouth in its Tail of Zebúwlan/origin and outcome. Ancient symbols of the serpent with its tail in its mouth admonishes followers/disciples of Dan to be to be wise as “serpents.” The dragon possesses different aspects. It is simultaneously a creature of water, of earth, of the underworld, and of the sky. A self depicting serpent or dragon eating its own tail—an Ouroboros—is an ancient symbol often associated with enriched teachings of various cultures. Carl Jung interprets the Ouroboros as having an archetypal significance.

The BODY is a shadow of the glorious TEMPLE of the Twelve of Yaoquv. The worm<sub>semen</sub> is a *seaman* that enters into to a sea of waters. What the worm becomes is how it is spun within the cocoonbodywrap. When DAN—the Serpent Body composed of the Head of DAN to the Tail of Zebúwlan, known as the Serpent of Antiquities that remains ages to ages, rises from the semen-worm, a conflict arises with the woman bearing the seed<sub>of</sub>manchild and the SEED<sub>of</sub>NAME. The thoughts of the worm will be drained/crushed to release the glories in the SEEDNAME, and the Serpent of Dan will change the direction in which the Seed is being spun/dressed unto its emergence from the woman. The focus of judgement prompts the discerner to cultivate their SEED-NAME with garments of Yaoquv/Father of glories (verses cloths of reflections that perish). A *GarmentWineSkin* of glories are woven from the OIL of meShich, whereby a Name emerging from their cocoon is not the same upon entering into the waters of habitation. From a worm a SEEDNAME rises with wings as a flying cockatrice (Yeshoyahu/Isaiah 14:29). “Rejoice not thou, whole Palestine (devoid of Knowledge of ALhim), because the rod of him that smote thee is broken: for out of the serpent’s root of DæuwD shall come forth a cockatrice, and his fruit shall be a fiery flying serpent.”

There is only ONE IMMORTAL. We, the Body, are EARTHHALLOWSPACES to be sifted through sands and waters as one pans for gold, claiming the prize of gemstones within clam shells for a Temple of Laúwi. Days in Ayshshur delve into Transformations of Becomings, which are set to ascend to the Faces of Geren, the Thresher, to sort out the grain from the chaff. The HAND of Geren prunes our branches from falsehoods and deceptions of embodiments/Chaúwah and saves our mission/assignments from deceitful beliefs/shells.

SeedName, the benevolence of BaarLeChaiRai sees and hears beyond your limited perspectives of becoming, and sustains the prophecies spoken and recorded in your Name though you sense misery and rejection of YishmoAL/Ishmael.

Upon this Hill of Avrehhem in the 19th day, which is the 8th of your birth on the 11th, you receive the circumcision of the heart. Hereby, the veil/seed coat of your Words is removed. By the utterances of the prophecies of YæHH, your Name is called, then unveiled.

The offerings of Yahúdah rise in the evening of the 18th from within the structure of the Words of Gad. The rod, from the two sides of the brain, is set to spin the thoughts ascending is 610 to 22/X whereby the TaúWah/X, the totality of your Name, as WORD, is in Seven/610/ to be complete/perfect: 6 2 1 2 0.

The Wood of Gad supports the ascent of Numbers of Yahúdah and their emerging Head of Aparryim in days 18 and 19. From your foundations, the Words of the Kingdoms of Yahúdah and Aparryim are established. Three categories of Names and their Heads join together as One unto Reshun as the last of the lives becomes primary for subsequent evolutions. The three firsts are 1) Gad, as in the beginning is the Word, 2) the House of Aparryim which is the first fruit hung upon the Tree of Lives—first in the body and the first/beginning of appearances; and 3) Yahúdah, the primordial formularies upon which all appears and progresses—first in the movements of rotations/marching/proceedings. These three come to the Faces of Reshun to mark the 18th day in which the Words of your Name establish kingdoms to inhabit your Light. Until that day, though the meShiæch is birthed in ShmúwAL on the 15th, there is no place for the Head to be set until the 18th day at evening, when Yahúdah comes to the altar, at which time Dauwyd receives the anointing flowing from ShmúwAL.

#### THE COMING OF THE MESHIÆCH/MESSIAH

Because evidence of the Anointing Oil comes through or appears through Number Codes of your parts—through Yahúdah, does not imply that the Anointing comes FROM Yahúdah. The appearance of the Anointing rises through all groups of inhabitants as all are a manifestation of the Oil in the Seed. The meShiæch appears in all Names whereby every EYE sees the Oil flowing from their Seed into their houses. The leavening regarding the meShiæch will fall from where it has risen in the minds and hearts of the peoples. Illusive hopes of seeing outside of your reality will be exposed as the Oil your Name rises through your Seed pipe-line to comprehend the inner testimony that the OIL is within the unleavened Bread of your Name. While all Words, as things manifest—come to appear through Numbers, what is the Source that causes the Oil to run from the North of Dan into the East of Yahúdah to define the habitations of your Breath (MT/Deut 32:8)? As Dan releases the Fire in the Breath, the Oil in your Seed is caused to flow. The Source of the Anointing comes from the LIVES of the FATHERS in your SEED, from the House of DAN—TheTen—the infused Spiritus to rise in your midst. The BREATH in you, as Fire that resides in the Semek Bones, causes the OIL to rise to your cranium. What are the implications of these Words as to how they affect your cognition of becoming? As your Eyes turn inward to the Anointing Father in your Seed, you see the oil in your SEEDWORDNAME appearing in the third day of ShmúwAL—on the 18th to the Faces of Reshun. The oil ascends over your waters, rising through your staff to spread out, forming a kingdom/dominion for your Name of DæúwD.

Your foot of Ayshshur dips into the oil of Dan whereby you are put on your journey to succeed (MT/Deut 33:24). Through the Oil of Dan, your Name rises upon the waters. In this manner, you walk upon their waters and do not sink, like a stone, yet to release the oil of ShayinOyin.

The ever present supply of Dan, the Judge of ShayinWisdom, keeps your seven lamps/eyes full through Perfect Associations that bear the oil to remain lite to see and enter into the doors of your bridegroom—the husband of your members, who brings you into unity with the Heads in YæHH. As you enter into DallathDallath of your betrothal, your Name no longer knows former habitation from which you have risen.

First a foundation of Wisdom is laid from your SEED, as RAúwaben is born first. Then Shamoúnn is second—the affirming member is birthed. These two parts of your SEED, your EYES and your EARS are the primary opening of the WordofyourName. The evidence of this Túwrah progression is apparent in the womb when the Egg of your GrandeMother—Bayinah (which has formed in your Mother as Wisdom) commences to put on the clothes of your Oil/Anointing/meShiæch by which you are robed entirely to appear from the waters of the grave. Then the oil of Chækúwmah in the Eyes of RAúwaben and the oil in the Ears of Shamoúnn of Bayinah, commence to run through the conductions/instructions of Laúwi/Levi, whereby the oil seeps into the House of Yahúdah, causing the Light of your Name to burn, as your star comes into the Eastern Dallath/Door. Yet from which are the Eyes appearing and the Ears? As Wisdom is not alone in the formations of the deep, your eyes must scale the ocean to see the side of Bayinah in the North (Mishle/Prov 8:1-15). RAúwaben is brought into the waters by DAN, and Shamoúnn by the waters of Ayshshur, and Laúwi, from the City of DæuwD in Nephethi, whereby a House is created for your Numbers to reside. As the OIL rises into Yahúdah—through the Door of YæHúwaH, the Numbers of your Name are activated through which your states of Knowledge appear. The unsealing of the Breath of DAN causes the oil in your SEED to flow by administrations in Yahúdah, whereby the pairs of Numbers of the Fathers 1-17, 2-16, 3-15, 4-14, 5-13, 6-12, 7-11, 8-10, 9-9, and 18—the River of Lives—runs into your blood. The Light of your Name shines from the darkness in your Little/Humble SEED and continues to rise through all of your parts to create the great harvest of BeniyMAN, the 12th of the Alta. The final portion of the oylah/ascension offering is the BreadofyourName, known as the coming of the Son of MAN (formulations of the MANna above).

Emerging from the Numbers of Understanding and Wisdom is the fruit of Aparryim, through which the Numbers of your Name enter into lands for your occupation. The purpose to enter into habitations is to make known/visible the invisible whereby they are handled to shape and refine the dwellings of Light. When the inhabitants in the dwellings understand their NumberBase they are transformed from transient soul forms into gemstones according to the glories in your Name. The stones are placed in the Universal Dwellings of YæHúwaH as the Corporate Body of The Name. Hence, in the parables, Yúwsphah/Joseph and Yahushúo/Joshua are the Offspring of Neúwn which bring all components of the Numbers of your Name into dwellings of YæHH/15. The 12 + the 3 of Laúwi/Levi, are the embodiment of the Twelve—the sum of 15. You abide in 12/3:3 to affect the Gammal emergence and progression inherent with your Name and its Numbers. Once the Numbers are released and called by Name, Aparryim appears as the first member through which all other branches sprout forth with their pairs. On the 18th of Nephethi the ten lives have affirmed your Name to abide with you, never to leave you, by their covenant and the Word of their vows. The calling of



your lives unto service are announced in all ears of malekim/messengers who are appointed at your sides. The 18th day is the blueprint of your lives and destinies. The gathering of the Fathers and your Name is known as the “first love.”

On the 19th, to the Faces of Avrehhem, your Name is sent on its journey of revelation. This Day is also known in YæHH (15+19) as 34 or the Pathway of Lammed. In being sent you are given the Lammed, the Instructions, evening and morning., which are more valuable than a purse. The Star of Yahudah/30—The Dallath/4 in HHaSham/26 (Jupiter) rotates around you in Shemesh every 12 years whereby there is LammedLammed to guide you as 24 Courses of HhaKuwáhnim. Orbital period of Yahúdah in 12 years; thus, for every year of your rotation you encounter messages of the Numbers, unto 12 x 12 144000 to cultivate your 12 into their gemstones as one/1 in the Tsur/44 of DæuwD. You are held by the right hand, to subdue/align nations/processes to your faces, and to loosen from your loins the strength of kings/rulers of the Lammed in your bones; to open the DallathDallath/Daltim two-leaved doors to your faces, whereby your gates are not shut (Yeshoyahu/Is 45:1). You are sent forth with your sac of Numbers and Blessings. As the Numbers expand in the Name of Avrehhem, you form the radiance and crown/Qúphah of Tsædda/18-19/ῥΦ. Expanse occurs in your Seed as your Name is faces to faces with your gifted Numbers. The Numbers of ALhhim are meek, capable of being joined into wonderments, merciful without condemnations, knowing the inherent Values in all your see to be of the Lights of YæHH. As the Numbers, you remain steadfast, unflinching, side by side, faces to faces, mouths to mouths, to impart freely your pure, incorruptible gifts of joy and strength. Blessed are the meek, for you inherit the earth designated lands of the Fathers; blessed are the merciful, for you are shown mercy; blessed are the pure in heart, for you see the love of ALhhim in your core and in your dwellings, and thus; you abide in peace without fear.

In that YæHH/15 is before and in all days, there are 45 days in a period of instruction/lunar rotations/30 of Light. 45 conveys cosmic solidarity expressed in the lives/18 of all beings/9 (27). The Light contained in what is assembled/27/9 (5 x 9 = 45 are the ῥΔ4/Adim) noted also by R. Allendy. DaniAL refers to a period of 45 days declaring bliss who pass through the Daltim and reach unto the end (DaniAL 12:11). 1290 days pass when daily offerings are set aside. Blessed is one who perseveres and attains 1335 days: 1335-1290=45 days. The summations of Lives are in Tsædda/ῥ/90 45:45 as 123456789 and 987654321 are the sum of 45 respectively from side to side. Twelve gates of 45 are 540 days. “Chinese geologists believe that 1.3 billion years ago one year on planet Earth lasted for 540 days, 13-14 months with 42 days in each month. There were 15 hours in one day.”

There is an undeniable charge from planetary alignments with the offerings, unless it is deemed coming from some other sphere by a loss of cognition to the Source ever present in your Name. A postulation to dismiss understanding what we are and where we are going would be to bury our heads in the sand instead of standing upon SeedRock of our Foundation. As a plant we respond to the illuminates in their seasons which are by their hands.

Unto Mount Hor you rise on Days 20-21 to receive your assignments and are commissioned/sent two by two. The first of Knowledge is ALozAR, day 21, unto whose faces you bear fruit upon your strands of AL. Deposits in your OYINZAYIN Eyes are released to flow from AL to AR.

## QUALIFICATIONS TO BE CROWNED KING OF YAHÚDAH

Through expansions of your SEEDNAME you come to be faces to faces with your Numbers, whereby you spark growths in grace from Mount Sheooir/Seir into elevations of Malekkiytsedeq. This attainment is known as entering into the Order of Melchizedek—elevations of the Kuwáhnim in which your Name is aligned to its origins within and above. In that every growth is by grace, you are whitened as cedars of Lebanon unto the peaks of Mount Húwr/Hor. What is of Wisdom of ALhhim in your SEEDNAME has become aligned to your side of Bayinah, whereby you are Tsaduwk to rule as a malek/king by the Lights of the Sun and Moon over and in your habitations (Mishle/Prov 8:14-16). From this elevation you see beyond, through the eyes of Avrehem's circumcision of the heart, through which you have emerged. Hence forth, you enter into in the Aharuwnic Mind at all elevations and their Orders. The remaining ten days of Nephethi are as at the first; however, the fruit of Knowledge—a flowing of the Ten Lives is obtained by Wisdom, days 1-10; Understanding, days 11-20, unto Knowledge, days 21-30. These three tens correspond to your 30 Numbers that rise from your root, to your stalk, to form your upper branches.

With a whitened seamless robe of Yishshakkar you enter to the Faces of Malekkiytsedeq attesting to the opening of all rings in your Seed unified as one. All former spots—deposits of Knowledge in your SEED, have been cleared, and your seed fully opens its garments without folds/wrinkles. With a blast of spring air, the House of Dan opens the stalk and branches of your Name, which have been sealed/reserved by judgment for your harvest, to bud and produce the fruit—the sweetness of the Fathers in whose Names you appear. The unsealing of your Name by Dan causes the sap of the ten lives to flow unto bearing the Words of Knowledge upon your lips.

In Day 22 you come to the Faces of Aharúwan who pronounces your blessings and opens the gates of the shabbet to enter into the Rest of the Fathers. The Light of Zebúwlan in your Seed of Beniyman enters into the summations of your illuminations. Day 23 follows as you are endured by NaDæv to fulfill the seven days unto subsequent habitations. The Light in your heart—Zebúwlan returns to the altar as your inner Light comes to the hands of the freewilling spirit of Nadæv to be spirit to spirit, Light to Light, from which you originate.

Day 24, to the Faces of GerenHhaAuwernehHhaYavúwsi, you separate the chaff from the formed Seed of your Name. You must winnow the grain to obtain the Derek/Path of ascension, whereby the Words are heightened, unbound, harvested from their stalks. When the Word is in the shell of Letters, it is still confined. Your WordName must be tossed to the Wind of Dan for evaluations, separations from the tares, to obtain the dd patterns within the Seed. Your SeedName being of two sides, enters into the Δ Derek Path of Wisdom and the Δ Derek Path of Understanding which are the two sides of the altar. Father Geren is the right side of the heart; Auwerneh, unto Masteries of the Yavúwsi/Jebusite forms the left side of the altar.

Your Word rises from ΔΔ loins to ascend from the heart of DæuwD, then to the Light of Aharúwan in the mind/cranium/skull/golgotha. Your Voice of Dan speaks from your left unto the right—the manifestation of your Body/dwellings which does not go beyond from which you are speaking. What is in your SEED connects inseparably to the Semek, the wood, to make your ascensions and enter the DallathDallath passageways.

In Days 25-26 you stand with your Eyes opened by the judgement of Dan unto the Faces of GerenHhaAuwerneh to see yourself as you are fore-known and ordained. You come to Mount Karmel with full hearing/comprehension of the eternal body of unfading glories. On the last day of Nephethli, the 29th, you return to Mount Tsiunn with joyful songs. The darkness in which you were once robed has been turned to Light, to be the ShayinOyin Lamp, full of the Lights of ALhhim.

In day 29 of a moon your days of Núwach/Noah are fulfilled, having risen through your waters. The summations of 29 evenings and mornings are 58 אג/Νúwach. In making the shabbet offerings, your heart is constructed for the Light of Bayinah to reign in your heart with Understanding.

In that your Name is born, with your twelve, from the altars, how do you read understandingly the birth of the Twelve from Yaoquv/Jacob, who are born in the Land of Paddan Aram—the fields of the Heart in which Your Grain is parched/opened/whitened—in Charan/Haran? In the midst of the peoples of the East—Yahúdah, Yishshakkar and Zebúwlan, are your glories formulated to appear as your Houses of Origins, which are your Numbers, Mission, and Language—Layshuwn Hhæqudash (Hebrew: וּדְבָרֵי יָרֵךְ), the Words in your Seed. In the heart of Laban—the *lav/heart of the Neúwn*—Yaoquv acquires the Twelve of the Staff of the totem-pole Faces in 12 Heads, to embody the 4 sides of Light. e.g. The 4 Mothers of YishARAL, as the 4 sides of Light, bring forth the glories of Yaoquv to reside in twelve precious stones. The recounting of the births of the offspring of YishARAL reveal how your 12 appear to formulate the glories of Yaoquv. Your birth from the East commences from your wealth of Numbers, starting in Yahúdah unto the Crystal Stone of your Name in Beniyman. However, the Tablet-Record-Luach of Nephethli, records your birth, from the Fires of YæHH, as prophesied upon the ALTars of their Mountain which set into motions the tier-evolution of your Name to be born-again/from above by Father Yaoquv. The births of the 12 are prophecies of Yaoquv unto your appearance as Beniyman who is brought forth in BayitLechem/Bethlehem. The twelve of your Name rise as the Bread of Shebuoúwt/Shavuot, as Your SeedName is the Bread that comes down from the Fathers.

As a Teacher of your Twelve in YishARAL (Yahuchannan/John 3:10), you understand that you are begotten of The ALhhim in the waters, and that your subsequent birth comes by activations of the glories of Father Yaoquv to be revealed through Fire. Through being in the Eggs of your Mothers, you are called to judge your House of Dan by Fire. Through judgments of ALhhim in your body of definitions—in Metsryim/Egypt (SYM/Ex 12:12), you come forth out of a watery grave to obtain your glories of imperishable stones—the soulbody of your becomings of ALhhim, the purpose of which you have put-on grave clothes to redeem your soul of Faces. **Your Name rises as the Stone of DæúwD, to lay your foundations of the Mishkan Tabernacle of YæHH for the coming of the Judge of DAN.**

*The  
Judge*

## The Serpent of the Seed

The House of Dan rises in BaniyMan

The Worm the devours/transforms the Bread of the Grain

The vertical column 1,5,9,7,3 are 25—the ascent of Reshun

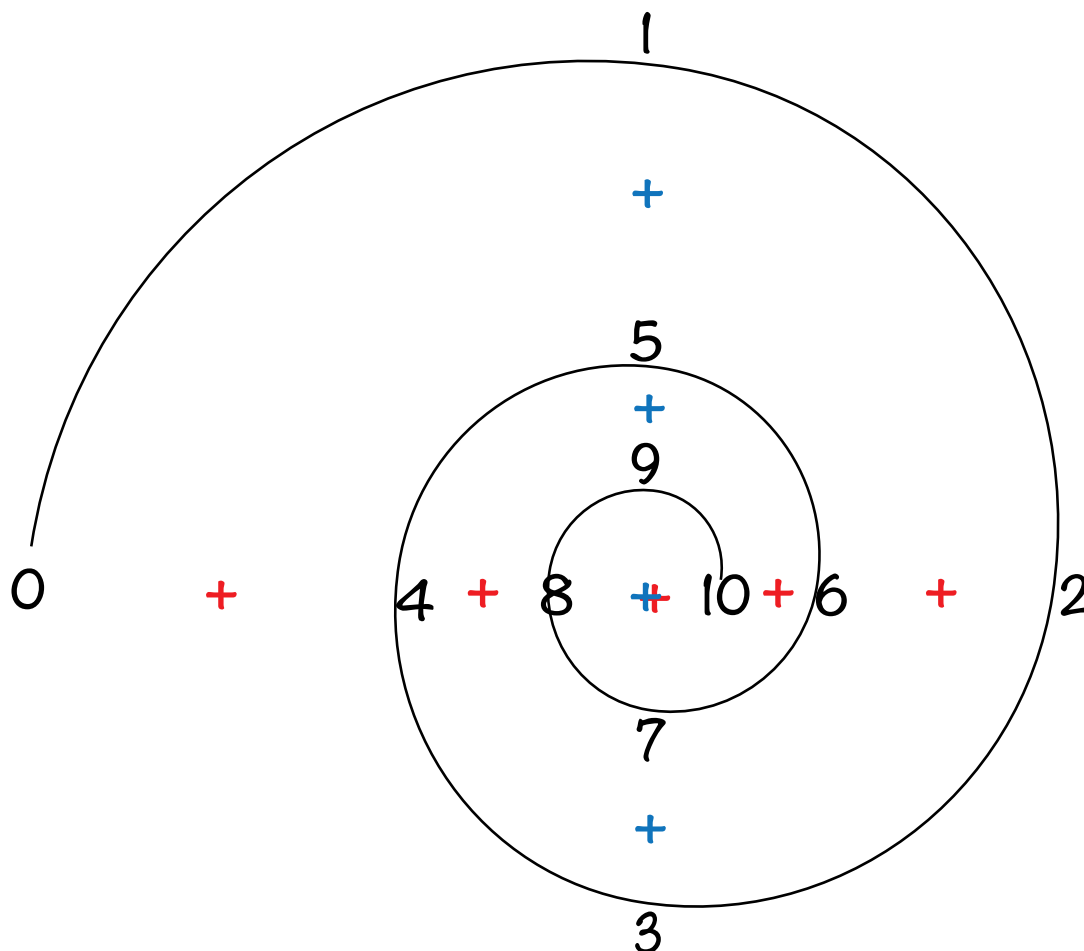

The horizontal from east to west are 0,4,8,10,6,2—30—three tens—the Teachings to fill your serpent belly, your hands and your feet.

The origins of Dan/10 are in the NiNe/9 of BeniyMan/152 01=5x2/10 to reveal all that it is given

The Serpent strikes the Horse causing movement, shift in directions, a change of riders.

Dan, as a serpent regulates a House by Wisdom, unfolds itself in the waters, unwinding counter-clockwise to form a body for judging its parts.

As you draw out your resources to know them fully, they move clockwise, except for Shamóunn by which you behold yourself coming/appearing and going/transferring.

The faculty of hearing —Shamóunn, as Venus and the moon, assemble at all times what is unfolding in Dan. Your offerings—givings—return clockwise to the centre, known as what is above—the force regulating what is without/surrounding. Your core is known as the qudashqudashim—holy of holies—what ultimately distinguishes your habitations. As in the core of Seed, so in the Core of Dan are the Lives, the Numbers and Words of your Name.

What is below is the court of the qudash/distinguished/holy which receives from what is above, giving support for the progressions destined for your serpent. Within your habitations are 3 court yard squares around which are three inner and outer circles/eyes of consciousness surrounding your four points making the Shayin Seven Eyes of DaN hung upon Semek as the inner sustaining ring.

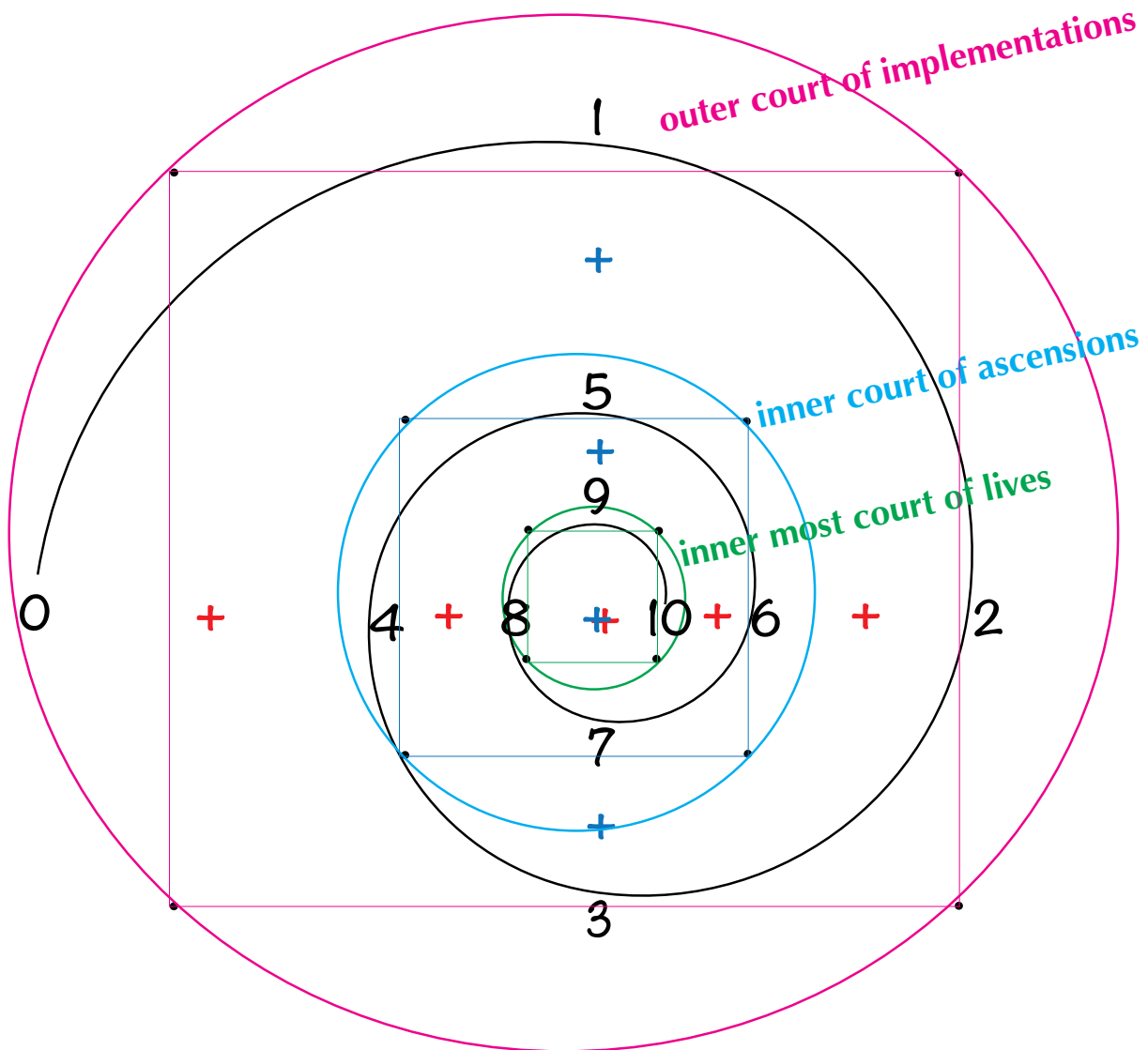

## The JUDGE יָדָא

In Reshun your Seven Eyes open as Seed of Dan awakens. The opening of your SEEDEYES is the First activation of a Name in accordance with your appointed prophecies to ascend. The Head in the Seed no longer slumbers, but rises on the Third Day, fueled by the inner joys of Father Yetschaq and Father BaarLeChaiRai—sustained givings. Through openings of your Seven Eyes you come into the world to see what you are given from above. With your eyes open at Metspneh you attend to your dwellings with judgements/contemplations according to the good purposes of the ALhhim. The opening of your Seed prepares a place for your Light to dwell fully in the Seven Eyes/Oyin of the Fathers.

Upon taking a glass of water, one should utter, Baruwch Dyn—Blessed/Exalted is the Judge who appoints my states of residence! Every drop/cell of water is made sacred by your Breath.

The JUDGE appears in the midst of the Faces of Light—in the midst of the Fire of their offerings whereby the outcomes are determined by what is in your midst. To Judge is the ability to evaluate, to rightly comprehend, what you are given unto that which you are becoming. The idea of condemnations only pertains to what is contrary to your becomings, as only the chaff is burnt while the increase of the Seed of your Name is garnished from your dwellings.

The foundations of making decisions—judgements are laid with mercy and compassion. In view of stages of transformation, the Bayit Dan—the House of the Judge—pulses with the Source of what appears from that which is Invisible. The eyes are focused on a clustering of 40 Names, positions of Light, collectively abiding as one House of Judgment. Is there anything above or within this cluster of Names? They appear as a conduit of Fire through which all comes and goes, appears and disappears. In making an OL Oylut—to elevate ascensions—the glance shifts from what is thought to be the apex of the Fathers to behold YæHH, the Fathers, to becoming the Faces and Bearers of the Seed of Judgment. 40 Names rise in Yishshakkar which comprise your Waters above. The values of 40 correspond to the Letter Mæyim/מ/40 whose voice is heard in all waters. These 40 Names determine the States/stages of Beholding the Eternal Fire that is fueled by the Ascension of Faces. The 40 Names are those rising, to be seated above, from 70 counsel members in your sanhedrin—council-chamber—the 70 Names in your 12 Houses to whom you confer regarding your proceedings of transformation (CHP/Num 26).

Considering the Judges as the Source of Dan is quite a humbling experience. The communion heard is that there is no one to be worshipped as a supreme being, but all abide impartially one to another. Ideas of supremacy are contrary to their Names of Elevations and Distinction. Those who verify themselves worship/serve in realms of the Mountain/Illuminations in Spirit—by their intelligence and by Truth—verifications of their Numbers and Words.

When one appears from waters, their Faces fuel the Fire as ongoing combustions/fusions/consumptions. As you make fusion with the Eyes of the ALhhim, whose lips tremble to speak your Name, your Spirt becomes an activation of the Fire of Breath within your designated Water dwellings. Herein, you enter into al-chemistries of transformation. Your leavened loaves of bread, as seed body parts, are transformed into unleavened seedstones of jewels. In the Body of 40—the waters above—it is deter-

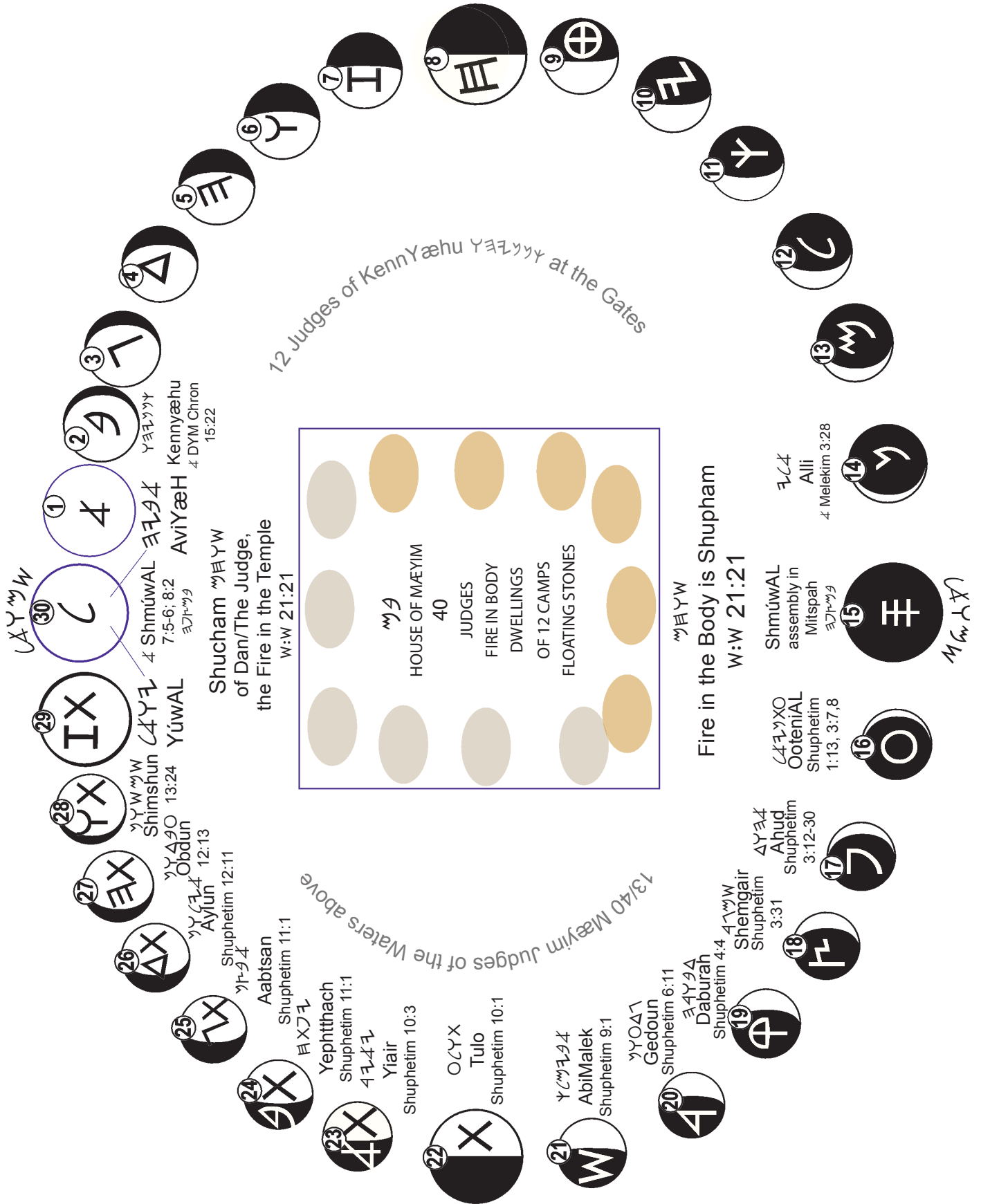



mined what is in the waters below—states to descend into and to emerge out of the waters upon seeing your ascent of Seed. The teeming of lives is a heaving of spirits in the waters, those abiding in the seas of Wisdom, and mammals emerging from the waters to reside in land bodies with Understanding; and those abiding in the air by Knowledge, to carry sacred waters of Breath within their soul vessels. Every spirit resides as determined by the what is in their Breath, according to associations activated with formularies of Numbers and Faces. To what degree your Spirit activates your numerical formularies, your purity of refinement and cognition are measured. The harmonic whitening of understanding exudes its consciousness to be in agreement with your Numbers.

When your internal awareness rises with inner realizations that you have been gifted with Light—Numerical substances and that you belong to the Soul of the Worlds, you seek to perform the services of your Name to the honour and well being/actualizations of the Unity of all Names in agreement with Words of the Judge. Upon these occurrences, the Light in your Seed appears and begins to fill your eyes with Wisdom and your ears with Understanding so that Knowledge forms on your lips.

“Assuredly, from the WombWaters of Ayshshur, the Voice of Shayin Oyin speaks. In your regeneration process—when your Name is activated to make ascensions from the waters of the kaiyúwer/templelaverbasin, the Son of Man/BeniyMAN—*your Seed Name—emerges and comes to sit on the Throne/Stone of DæuwD of your glory*—The Stone Sepulchre from which you have risen. Consequently, those members in you who follow ShayinOyin—the Oil that precipitates from your Seed, *will also sit on twelve thrones* with your Head as they rise to the apex of your twelve branches sprouting from the Vine of your Name. In the 12 organizations of your Seed, you judge yourself to evaluate and appoint your stages of developments—those of YishARAL—the bodies in which your Fire dwells in ARiAL. As the Shayin/Sun and Oyin/Moon rule the day and night, your Name rules over your 12 as the judge of your houses by the Lights in your Name. As you come to sit upon your ascendant Stone you also will sit to judge—appoint with mastery the 12 branches of your Name unto their glories, that they become fully activated as you, unto their services in ShayinOyin. Metiyæhu 19:27-28.

The JUDGE of ShayinSemek WÆ reveals their Faces through teachings of the Semek of YæHH. Their Flame continues to burn in your bonesofcrystals in which their Light inhabits. The Light of their Fire, called by their Names, is continually surrounded by the Judges, as the Defense of Dan surrounds Zebúwlan in Shemesh/FiresofSun—the unapproachable ball of Fire (1 Barnava/Timothy 6:16). There is at all times, beside the unified ones, the Lawgiver and Judge, who is able to save and destroy. The Judge is the ultimate reality of your use of Words. There is a judge for the one who rejects Wisdom and Understanding whereby they are not able to receive revelations. Words spoken judge the one to whom they are appointed on the last day/outcome of a deed.

The Judge of Judges: ㄥㄚㄣㄣㄣ  
The Fire of a Name Judges within its Waters.

According to the prophies of your Name, Judges rise in your defense and rightly discern your inheritance, to evaluate and comprehend your Name without shadows of your Light. You are known unto that which you are becoming, for your fulfillment of days (SMS/Acts 3:24).

The Judge of your Name, ShmúwAL, commences to discern in Metspneh/Mitspah—in the watch tower, as an expectant watch-observer. Your NameJudge observes, from the pituitary in Yishshakkar, the offerings of your kevashim/sheep coming to the mezbach/altar (ALphæh ShmúwAL/Samuel 7:6).

The Judge of Judges rises as the first prophet—your initial prophecy of Name: ShmúwAL:  
 𐤇𐤃𐤕𐤍𐤁.

The Fire of a Name judges your Waters and all in them. From both sides of your Fire, two Names are appointed to serve, to keep the Fire burning and to re-allocate your resources into locations as you make transitions.

THE 2 JUDGES STAND ON THE 2 SIDES OF FIRE OF YOUR PAIRED NAMES 𐤍𐤃𐤕𐤍𐤁,  
 WHO ARE OVERSEERS OF APPOINTMENTS

YuwAL—the Giver of Strength, formularies of Light and their residences.  
 AVyiYæH—My extensions of becoming through radiating the Faces of YæHu

As your Spirit breathes through your parts, from both sides of the Faces of YæHH, evening and morning, you enter and pass through the Faces into their 12 Heads of Judgement. What you carry in your Breath is detected as to intentions and accepted obligations. The Tsæddda 𐤃𐤃 of your Spirit is a barb that attaches to Values and Thoughts carried in your Breath. As you ascend in the Seven Hills, your Spirit becomes free from illusions whereby you are able to enter into realms of the Enlightened Ones. Passing through the peaks of the Crown of Yahushúo, you enter into realms of Judgements discern your comings and goings.

The Crown of Shayin Oyin WO is composed of three Fires WWW, the Fires of Wisdom, the Fires of Understanding, and the Fires of Knowledge in the three levels of Hills. These Fires are levels in Semek/𐤍, the root, the trunk and the branches upon whose Teachings, as Wood, you rise through your oylut/ascendant purposeful ascensions.

Your emergence are from realms in which your Spirit has been snared, as in a trap, activated judgements—re-determinations of the ALhhim in which you appear (SYM/Ex 12:12).

From the Rings of Adim/Adam unto animations of forms, 𐤁𐤍𐤁𐤍 𐤃𐤃𐤕 𐤍𐤃𐤕𐤍𐤁  
 and in accordance with the ALhhim of Metsryim/realm of definitions, 𐤍𐤃𐤕𐤍𐤁 𐤃𐤃𐤕 𐤍𐤃𐤕𐤍𐤁  
 judgments/redeterminations are executed. 𐤍𐤃𐤕𐤍𐤁 𐤁𐤍𐤁𐤍  
 Anni YæHúwaH; the Single Voice 𐤁𐤍𐤁𐤍 𐤃𐤃𐤕  
 of Aharúwan, makes supplications for your Collective/YæHúwaH, to speak with evidence.

Thinking of Rabbi Shimon Baar YoChai, who escapes death by entering into a cave for 12 years. With Rabbi YoChai is his son, ALozAR, who is taught and records revelations of the Túwrah over 12 years in a cave. Each cycle of 3 years pertains to four sides of your Name to cultivate Wisdom, Understanding, and Knowledge. What you discover is kept in a record of ALozAR—Father who unifies and keeps your Light of your Strands of Faces in your Name’s lineage.

In that Rabbi Shimon and his son ALozAR only had the clothes on their backs, they created holes in the sand to abide in. They reserved their clothing for their attire in making evening and

morning oylut/ascending offerings. In this manner we keep our sacred clothes spun by the Queens for our appearances to the Faces.

How is this story a consolation? When you come into the world for ascensions, you recall what it is that seeks to put your aims to death—to retard or kill ascension and transformation process. The coming into the world is an agreement, by a calling, whereby you are sent for your expansion of Light with midwives to oversee your births of Name.

Those who make the ascent as Hevel/Abel, maShayh/Moses, Yúwsphah/Joseph, Alishayh/Elisha, Aliyahu/Elijah, Yahushúo/Joshua, and Rabbi Baar YoChai, all realize that there is a threat to entering into “foreign territory.” Realizing what seeks to put your Name to death, to cause you to slumber, to keep you from making your oylut offerings, is a beginning stage of your saga to emerge. Without realizing what it is that keeps you drowsy, you remain under the hand of your taskmasters and the surrounding noise of the world that competes with the inner voice of your Name to RISE.

Upon hearing in Shamoúnn that there is a force that seeks to disdain your Name, to count you as unimportant, Seed not to be opened and cultivated, you bring forth a renewed dwelling of Breath, as Sath/Seth XW, to contain the Fire of your Totality. By Wisdom you bring forth a level of speaking of the Serpent, as a meek one, whereby maShayh/Moses appears in the Nile. In seeking to find the Words to be spoken you are sent the Servant Aharúwan/Aaron from the mountain to assist your questions and distribution of Seed. You find a place to abide in a widow’s house, or in a cave, to follow the dreams of Yúwsphah/Joseph to take the child to Metsryim, a place to hide out: *a metsphun*, a hidden place, conscience, to encompass your treasures. Yúwsphah in every generation is your Saviour of your Soul that prepares a place for you to reside in the protective Lights of Bayinah/Maneshayh and Chækúwmah/Aparryim. By the dreams of Yúwsphah, the plan is set to restore the wine cup of Understanding and to set aside from service the bread maker of flesh. As the Seed of your stalk from prior progressions is recalled in your days of visitation, you are transferred from one place to another for your twelve to lodge with you. Through Shamoúnn, your hearing faculty, you transfer what is your origins, passing through waters, to rise to the cochlea spiral with understanding. When the sound of the silver trumpet is blown by Aharúwan, you transfer what is in the womb of your spirit to be heard with clarity to proceed in your Path Way (CHP/Num 10:8).

In memory of Rabbi Shimon BarYoChai, you abide 12 years in a sandybody, to study the 12 houses in your Name. Upon which you emerge with the Fire of the oylah retained in your Spirit to transform what is of the servitude of the world to higher exercises of transformation. In that you enter into the world without apparel of this world, you come naked only with those of your Name—woven upon the sprouts of ALozAR/Eleazar—your offspring that flows from your bones. Your children are woven garments for your SeedName to wear for your night and day excursions. The garments that you don are made by those who tend the distaff, by the Hands of the Queen who are Mothers from the lands of your descent. May you find you a *metsphun* for a consolation in your journey. The two primary Judges of your Name, that lead you to know yourself, from both sides of Light, are of  $\zeta\mathcal{A}\Upsilon\mathcal{M}W$ : YuwAL and AVyiYæH, your left and right side respectfully.

How do you make ascensions to enter into the Seats of the Judge? During the process of making the oylah to the Faces in the Seven Hills, the crown at the top of the Hills, from Shayin to Oyin,

becomes apparent. Through entering into the Fires, what was once as a serpent becomes transformed as a seraphim/burning one. When you desire to purify your 12 as your spirit, then they are one with you and the Fathers. You then come to reside at the top of your ascensions whereby the Crowns of YæHH adorn your brow. As gatekeepers, who are judges, evaluate your intentions and progressions, the Seven Letters of the Crown open. Through the Gates in the Crown you enter into them to proceed into the midst of the Crown, in which you see **the Judge of your Ages**.

#### THE 13 JUDGES OF THE LANDS/PEOPLES OF INHERITANCES/AFFECTING DESTINIES

##### OOTENIAL/OTHNIEL/𐤒𐤍𐤏𐤍

OoteniAL/Othniel/𐤒𐤍𐤏𐤍, (Shuphetim 1:13, 3:8-11) Judges in the Land of Mesopotamia—Aram Nehharim 𐤍𐤏𐤍𐤏𐤍 𐤍𐤏𐤍𐤏𐤍—your state of paired rivers. When the Spirit enters into its castle of habitations, flowing from gamete Rivers, Light energy begins to move in the lands for its dwellings. OoteniAL is the record keeper of your days in your habitations, namely those in your accompanying processes/nations of instinct, which are heightened states of the Kenoni, Chitti, Amúwri, Perrizi, the Chauwi, and the Yevúwsi. In coming into manifestations you encounter the five serreni/rulers of habitations which you overcome by your saviour judge, OoteniAL.

As your SEED Name of BeniyMAN opens, your Eyes commence to form by which you behold the Word/Lives in your Name. These perceptions concur in sequel offerings of RAúwaben upon the wood of Beniyman. As the Body of RAúwaben is fully given within the SEED of your Name, then you draw-in your Spirit, out of the North—in the House of Dan, to enter into your dwellings to manage your states. This is the first coming/promise of the Judge in your dwellings. The sequel offerings of RAúwaben, following upon the ascent of Beniyman, are related in the parable when the household of Yaoquv sees grain in Metsryim—to come into definitions for their habitations (SMB/Genesis 42:1).

OoteniAL judges 40 years whereby allocations of your Name are continually being evaluated as you abide in your waters/Mæyim/𐤍𐤏/40. Your activation of OoteniAL judgements pertain to what are known as involuntary instinctive reactions within the Waters. Your residency maintains your spirit with five components to regulate your lands, commonly rendered as Five Lords. These serrni/𐤏𐤏𐤍𐤏 keep things turning within you like “axles” (Shuphetim/Jdgs 3:3). Namely, 1) the perpetual ticking of thoughts—mind overseeing regulations of the Philistia, in which process the mind does not know the structure of the Light contained with the Words of your Name, yet wants to capture it as the ark/arúwn. 2) The process of forming the gamete—continual grain offering of semen production and menstrual cycles are of the Kenoni/Canaanites; 3) processing of food/nutrients of the Tsidun/Zidonians; 4) abilities to unite your members for activities/labours of the Chauwi/Hivites; and 5) mechanics of speech from elevations of Beool/Baal of Charmmun/Hermon are means to associate sound with meanings as an internal witness that all things are founded upon Words in order to appear/arrive at Chemet/Hamath—until the Fire in your spirit coordinates Words with that which appears in your bodies.

Judgments of OoteniAL/Othniel/𐤒𐤍𐤏𐤍 make-up your daily record of seasons, days, times, in your habitations of AL. These judgments are a formulation/son of Qanez/Kenaz/𐤏𐤏𐤍 of what you acquire by the Words of your mouth. OoteniAL is the upholder/brother of all secret Numbers codes of Kalab/Caleb/𐤏𐤏𐤍 as you sense direction to enter into your WordStates. Through the judgements of OoteniAL you come to rest with the natural lords of your watery-habitations.

## AHUD (5-1=4)/EHUD/ΔΥἄἄ

Ahud (5-1=4)/Ehud/ΔΥἄἄ pertains to mastering your reproductive energies unto branching your 12 of YishARAL. Through mutually aligning your parts of Wisdom with A-Hud, one to another in honour, judgments are enacted on Muaab/Moab and King Oglun/Eglon/יגלון which enable you to appropriate the Light in your SeedName to flow at the Mouths unto building up your SoulStones, verses draining energies, often in conflict with one another in pursuit of lustful eye and vain ambitions. Manner of overcoming vain dictates is by left hand of A-Hud, denoting the Hand of Understanding to apply Wisdom (mutual aligned parts) that supplies you with an abundance of grace to grow. Through A-Hud you confront what is driving your members by Oglun, depicted as the carriage or cart of the Great Bear in astral planes. The implementation of aligning your parts as pairs is a foundation to make ascensions of the oylut offerings (SMB/Gen 15:10, TK/Lev 1:8). AHud leads you to discern/judge your members according to your origins of stars. The Light in your Star expands by your Seed being Sent by the Hand of ABrehhem.

Alignments with the heavenly Light Bodies engages the spirals of your Numbers to be move with the impounding Faces of Yehu. The evening oylah/ascent moves in the same orbit as the Moon; the morning oylah follows in the concourses of the sun. While you face into the Paths of Light, you also carry on your back side the underlying results of your ascensions, ever propelling and sustaining you in your quests. The Navel is the central pivot point of the morning, whereas the Pearl of Great Price at the throat is the pivot point for the evening ascensions.

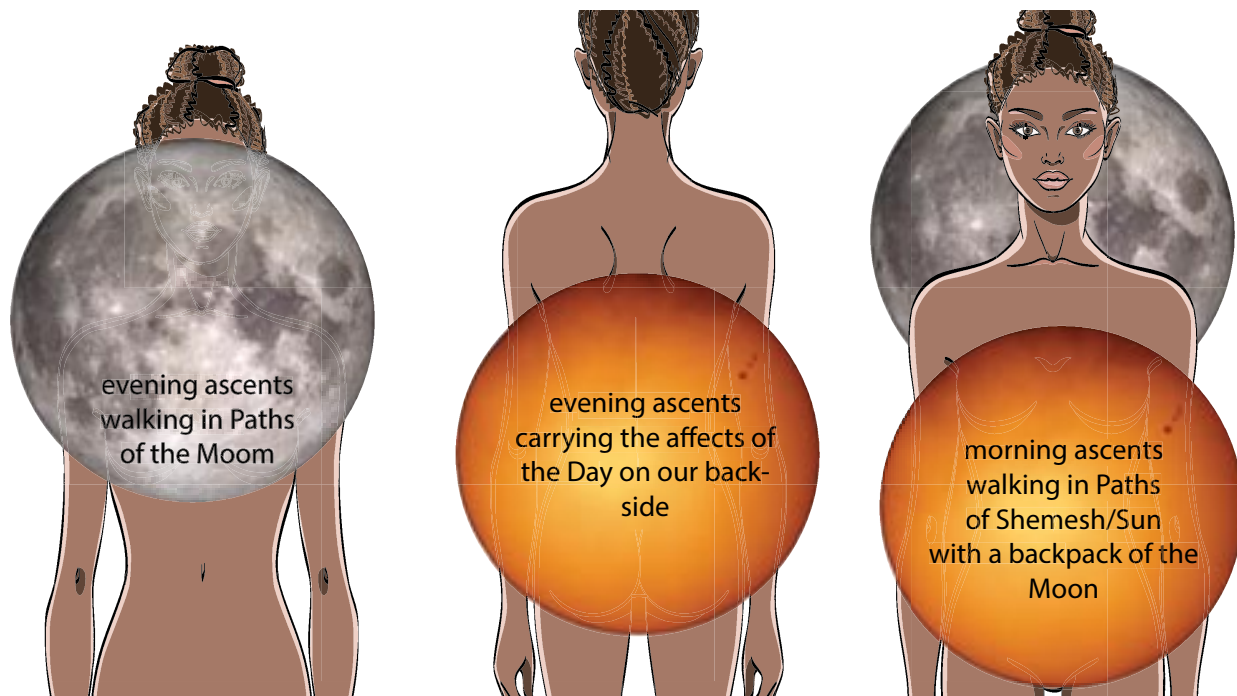

As two walk together in their ascensions, should one commence to fall to lower realms, the other bonded to them, lifts their comrade to their aimed footsteps together. As we are hand-in-hand and foot-to-foot with the Judges and Servants of Aharúwan, we are kept in the midst of the Faces.

THE 12 JUDGES OF THE GATES OF THE DWELLINGS/TEMPLE VESSELS AND SERVICES/DEEDS TO FILL DESTINY WITH THE STRANDS OF ALLI

DanAL, the pious judge is presented as sitting “to the Faces of the gate, in the place of the mighty on the threshing floor where Seed is milled/analyzed and set apart” (Aqht A, V, lines 5ff., Pritchard, Texts, 151). In the mishnaic period the Name, zaken, denoted scholars, and particularly members of the Sanhedrin or Bet Din/House of the Judge. The combined Judges of the States and their Missions are 26, those of the Name of YæHúwaH.

To love YæHuwaH and to love each other is the same, as we are all one. In so loving we affirm rather than shy from or quench the Fire that burns in us as a Collective Oylah. The levels one attain are according to giving what YæHH impartially hands to their Name. By giving your 30 Numbers your Name grows by grace and increases with strengths. We are ONE in YæHuwaH due to same measures of the Faces that are woven in our SEEDNAME. The 15 Faces are imparted equally to all Names night and day, without partiality. Upon your entering in the BayitDyn/House of the Judged, you are evaluated as to the extent of your givings to make ascensions. You are weighed on the scale of the 15:15 Faces. Nothing else would be worth calculating, nor could anything that is not of the WORD of your Name withstand the Fire to be Judged.

How do we know that every Name is given the same measures? The evidence is in the whitened bones of YæHH which sustain your Name to make your progressions through ascensions. Though Africans/deep blacks have higher bone density of Bayinah, than Caucasian, Asian, or Hispanic, the Number of whitish bones—256—are the same according to the Name of Aharúwan. According to SEMEK—the hidden support of your Tree/wood/assemble bones—you are given equal measures of the Faces of YæHH. Through multiplications of your Numbers, the Tree of your Name grows and spreads out. What is unseen—in your Numbers—increases whereby your faith expands. Through giving your parts to make the oylut/offering, you grow in Grace, the favour of the ALhhim as they see you appropriating what is gifted in your Name for the Collective Dwellings of Light. You have the love of the Fathers that binds your parts to the bones as one, and your Name has the love of your parts to be one to another, whereby adversity and division are not in your members. The mutual support of your members, one to another, is joyfully affirmed by them lifting up one another in the oylah. Our Names come into this realm to redeem our souls from corruption and vain pursuits that follow after illusions. Achieving **Perfect Associations** with another, and to love others as ourselves, sends blows to the head narcissism and self aggrandizement whereby we do not stumble from our goals in appearing.

THE 12 INNER JUDGES SURROUNDING YOUR 12 TO KEEP WATCH:

Yahuchannan, in the East, judgment of gifts/appropriations of graces:  
 DaniAL, judgment of spirit to govern, direction of mission  
 Mishael, judgment of Names as to their habitations/residences  
 Ruwdæph, judgement of Seed, activations of eyes to connect to Dan  
 Chananyahu, judgement of grace to build/appear/maintain/support  
 Azaryah, judgment of evolutions of Words  
 Yuwsphah, judgment of blessings/resources

Beniyman, judgment of expansions  
 GamaliAL, judgment of teachings/thought progressions into sequential forms  
 Achihud, judgment of weights/glories  
 DæuwD/David, judgment of gates/passageways/mishpat of the collective  
 MichæAL, judgment of ALhhim likenesses/compatibilities/achievements of unification

In the midst of the JUDGE is a Whitestone—activated by Light and inscribed with your Name. No one has Knowledge of what is written in your SEEDSTONE except those to whom it is given, for it your treasures to hold by paired Names (Shuphtim/Jeg 13:6, Chazun/Rev 2:17). What is in your Names is kept as a secret treasure for you to inquire and receive what you are given. By your gemstones, risen and forming at your crown, you enter into the House of YæHúwaH. As Living Stones you are placed in your appointed places to comprise the habitations of all Names from which you are called to abide. The 40 JUDGES are the STANDARD whereby you judge yourself to affirm your Faces in Yehu.

DAN INTERFACES AMONGST ITS BRANCHES DURING  
 THEIR DAYS AND SEASONS OF ASCENSIONS

Within rotations of Days, Dan has primary places of interactions that affect the entire dwellings of its Spirit. The affects of the Breath in a House during Ascensions are interplays of the Spirit in its Seven Eyes of RAÚwaben, and its dwelling places in Zebúwlan.

DAN UPON THE WOOD OF RAÚWABEN AND ZEBÚWLAN

As your Eyes become attached to see what is in your inner parts of Seed, then the House of DAN enters into your Eyes as a sequel offering of RAÚwaben to judge your members to be whitened/illuminated. Your Name is inscribed upon a white diamondized stone—the Stone of Dan—by which your Seven Eyes are shaped for the Fire of your habitations. All appointed for your Name by the Fathers is administered by the judgements/discernments of Dan—the offspring of Shayin-Semek that houses the Fires of the altars and the Faces of the Fathers.

Dan's ascent upon the Wood of Zebúwlan in a month affects the State of your Name's residence. The ascensions of DAN enter into your current residences of Light to update and affirm your Name to make righteous judgments as where the ALhhim have brought you to reside in a season; thus, to confirm, your levels of habitations with the Fathers.

Establishing a place of residences for the Fire—a shavbet, whereby Dan enters them by Zebúwlan's ascensions in month which provides Dan a place to bring judgement/right discernment of levels with examinations—a recognition of gifts that fill a house making its ascensions.

DAN RISES UPON THE WOOD OF ZEBÚWLAN

The impartiality of your Spirit is inherent in the Light of your Name. In being born of the paired Faces of Yehu, you know intuitively that you are one Light. In the day you are born in the altars of Yehu, it is a full moon Light appearing through the unified/two Faces of Yehu

whose Light shines as one. The Light of your Name is born out of the darkness of Bayinah which is appointed to judge all of your processes of Name, whereby the darkness of soul is whitened by your Light. The darkness is reserved for your habitations of Chækúwmah; however, in the Light of your Name there is no darkness. Hence, from where does the darkness originate if darkness is not within your Light? The darkness is made for a habitation as the body is formed in the darkness of your Mother in which your Spirit abides Faces to Faces. Hereby, there is no fear though you walk in the shadows of deep darkness.

The Stone of Dan is a diamond, able to pierce through veils, able to break open the SeedWord as a hammer, and able to ignite sparks in Zebúwlan as the Spirit of Dan breathes into the midst of the Fire. Dan is a gathering of the Lights of Shayin and Oyin, born of the Shayin/300 Semek/60; Fire and Wood of the altar, the full circumference filled with the radiance of HhúwaHhúwa, which commands/orders the Seed of the Fathers through which all is made/appears and by whom all is judged to be known (Tehillah 148:5).

#### DAN RISES UPON THE WOOD/TEACHINGS OF ALHHIM IN RAÚWABEN

As the Spirit of your Name enters into the Seven Eyes of ALhhim, adhering one to another within your SeedName, your Spirit prepares itself to be born of ALhhim. When your Seed opens, the Spirit of your Name awakens and rises through the Rings of ALhhim as that which is in the oak seed rises through its congruent rings/eyes.

#### DAYS OF DAN

In the Month of DAN, the first 14 evenings and mornings are days of the dispersements/givings of Spirit to form a dwelling of its Name.

On Days 1-3, the Spirit is sent forth with Joys and Blessings of the Seven Spirits of ALhhim. The joys of ALhhim are releasing SeedofWisdom, Understanding, and Knowledge.

Days 4-5, the Words stored in its Rings commence to thunder to affirm the activities in Its Waters. What is heard of your ALhhim commences to appear in Invisible Realms.

Days 6-7, the Words pulse unto foreseeing its habitations as one sees across the worlds from what is Invisible to becoming Visible. The glimpse of a lifetime releases Word-Prophecies as from Anna, prophetess of Ayshshur (Yúwsphah/Luke 2:36). Yearly, one sees from side of Light to another by its SixPairs; for a journey one sees from one world to another.

Days 8-10, the Breath affirms what is within its Luggage—Sacs of Seed through ascensions of Aparryim and Yahúdah, thereby programming what is to appear by the Numbers in Seed.

Days 11-12, Dan receives appointments as to its mission that will ever be supported by the depths of Maneshayh. The mission of a Name is confirmed to be Sent into the World *to fulfill the Days of ALhhim*, often confused when one thinks of fulfilling their own personal objectives within destiny.



On days 13-14, the offerings of Beniyman and Zebúwlan rise in the House of Dan to determine where a Name will come to reside. The SEED of a Harvest rises into the RayishOyin Heads of Intelligent Labours of Yishshakkar that are appointed (in days 11-12 of Dan) for the Seed of Beniyman to be cast. The Breath of Dan causes the grain to turn white, unto a harvest. The whitish Seed, upon being harvested, then turns golden “as the SEED is extracted and settles by the Breath of DAN blowing upon the Gold Stones in Beniyman. According to what is drawn out of Understanding, a State of Wisdom appears. The Breath connects, calling to Its 12 disciples in Seed and appoints them to be hung upon the Vine of Zebúwlan, to make their ascensions, the *raison d’etre* of coming into the world. The calling of your 12 to abide by your side is the journey of your Name to appear unto your Fathers, declaring that the Faces in your 15 members of soul/12 and body/3, are one with the Fathers.

On the 15th day of DAN, a Name enters into its dreamsleep to make transitions from one world/state unto another. All compiled by Breath during 14 days comes to reside in Zebúwlan, which is seen as the HeadTail of RAúwaben rises during the night of the oylah of Dan to peer into its Household of Fathers. Zebúwlan, of the ALhhim of Hhúwa and Gammal, are the centre of recollections to rise and flow freely. A Name remains in slumber until Its Name is called forth, with Joy, from within the definitions—*metsryim* in egypt by which a Name rises as Seed opens to the Faces of Yetschaq/Isaac on the 16th Day of DAN. As Dan comes to the fore of the 16th, to manage and rule all that it is given, the Breath releases all storehouses of Words into the Rings of ALhhim to appear with Wisdom, Understanding, and Knowledge, whereby offerings of Dan and RAúwaben continue for three days: 15-17. From the 15th day, when your Name appears to Father ShmúwAL, all contained in your FieryWaters—Vapours of DAN, harmonize with what is in your body of compositions of Breath. Hereby, it is the Spirit in you that mobilizes your appearances, levels of Word Residences, and progressions. Days 15-17 of DAN release the Invisible Blueprints of Wisdom Understanding and Knowledge to be Visible.

The HeadName of DAN: AchiOzar bann OomShedi/Shaddai is the Head of Mysteries, the Head of the North—by which what is assembled in Kesil/Star Centre of Origin is transferred to reside and become Visible (CHP/Numbers 2:25). The HeadName of Dan is a compound of utterances: Achi, meaning My support/brother, is a HelpMate, a generation of OomShedi, Oom—with all assembled in universes that is an abundant, unlimited supply of affluence/Shedi. As Chaúwah/Eve is called an Ozar/a helpmate, the Body of Dan bears testimony of your AuwD/Vapour of Witness, and is the paraclete/comforter of Breath that is the help-mate/ozar to your Name. By the Spirit of Dan, Man does not abide alone, as all Names abide together impartially.

#### THE FATHERS OF ORIGIN, THE SONS OF MANIFESTATIONS, AND THE ABIDING HOLY SPIRIT OF DAN

The appointment of the Paraclete/Judge Advocate of DAN follows the ascent of Yahushúo as the promised coming of the Judge (Psalm 98:9; Metiyæhu/Matt 16:27). Upon ShayinOyin of Yehu—Yahushúo rising within you, the Hand of Guidance for your Twelve is now appointed unto the Spirit of Dan to be your Residing Comforter (Yahuchannan/John 14:16). The Breath of Dan is the HolySpirit that sanctifies your dwellings and deems all that is in you is Holy-SetApart for your Name. In the last days of your harvest, the Breath of Dan, as a mighty river, breaks forth in tongues and songs as one enters into their ascending Shayin Oyin habitation. The ascent of

Yahushúo precedes the empowerment of the HolySpirit. As you have prepared your house by your members giving all within your Seed, the Body of Wisdom and Understanding rises through your ascensions, depicting the OIL/Christ having risen, whereby there is a place reserved in your Temple to receive *the promise of your Father* made upon your ascensions to be upon you. Journeys in the universe provide a path of discovery to draw out the Wisdom and Understanding from the sides of your members, whereby they ascend until you become clothed with their garments and authorities to rule your nights and days. In making ascensions you demonstrate that you are the Offspring of Yehu and *remain steadfastly* in the city of Yerushelyim—in upper chambers of the Seven Hills—till you are clothed with power—authority of Dan, from on high—of the Shayin Semek ALhhim. The Anointing of the Fathers comes as a dove that finds branches of your olive trees having withstood the flood. As Yahushúo rises from the waters of the Yarrdenn/JorDAN River a dove lites upon him. Seeing your branches ascending by Wisdom and Understanding signals the dove and angels/messages of ALhhim to land in your branches which activates the resident Words contained in your SeedName. For how can The Dove land when your branches are yet within the waters of Mother? As your branches of Seed rise and become evident above the waters, the Dove of Consolations comes to abide with you, affirming you as Offspring of ALhhim, with those aspiring oneness with the Fathers.

What does it mean, that it is woven into words, for Yahushúo to ask/employ the Father, and he shall give you another Paraclete/Counselor of Judgement, to abide with you for ever (Yahuchannan 14:16)? The term to give, NATHAN/NETEN, and to send, SHALACH, indicates how the Father SENDS.GIVES.RELEASES the Counselor of Judgment.

It is understood that the Sides of our dwelling ever live—ascend with our growth stages. Naturally, as the inner parts develop, the Sides of the body elongate to contain the inner embryos. The Sides are said to make intercession for us; the left side supplicates in the night; the right side supplicates in the day. In that the Sides of Wisdom and Understanding house the Faces of Yehu, they are continually in communicate with the Fathers. Yes? For how does the body expand, grow in height, if not in contact with the Father in your SEED? As the sides of each of our parts rise, then they speak, signaling to the Fathers a state of readiness, who only knows the day and hour of our appearance, being foreordained for us to appear. The Father then RELEASES from the composite SEED as to what time the coming of Dan shall be in our states of appearances. As a TREE, when does the SEED release BUDS? When does the stored up energy in SEED cause a plant to FLOWER? To Hang on fruit? To increase SEED for a harvest? So likewise, as the Body of ALhhim houses our Names, and are continually in communicate with the Father in Seed, Wisdom and Understanding rise within us, personified as the ascent of Yahushúo, whereby the Father in our SEEDNAME then releases the BREATH of JUDGEMENT to fill our chambers with Knowledge that you are not orphans, but native born children of the GrandeHaus. All that is in YOU is HOLY, set apart for the BREATH of your ORIGINS.

In your comings of DAN, the Breath upholds your branches, making them stout. In seeing your pledge to be the Offspring of ALhhim, you receive the Spirit of Judgment. Your Name is resolved with judgements/determinations to bring forth your 12 with uprightness aligned with the 24 Heads in Yehu. Your 12 rise from the sure foundation Stone of DæuwD/David—the firm foundation of ALhhim cohesive rings as one, which remains and stands, by which you are

sealed in an encasement of the Breath, as stocks of Seed are secured to the Founder, or as a bee seals its golden honey. An imprinted impression of the Name אַיִן appears in your forehead with your Name, as the offspring, inscribed together. YæHuwaH knows those that are Theirs; hence; every one who subscribes to abide in the Name of YæHuwaH withdraws from iniquity.

By functionalities of AchiOzar—your Brother of Support, your Name appears with all furnishings of the Tabernacle/dwellings of Names. Dan activates your Seed, causing an appearance in the East, by breathing, as spring winds, upon the Head of Yahúdah, whereby the 30 Numbers of Name are released within Seed—creating designs *by the cutting/carving of the SeedStone*, to form a mishkan/tent of the meeting of the Fathers in which your Name and your branches/disciples/learners of Light come to abide (SYM/Ex 31:1-11). This Body of Understanding, from Dan to Zebúwlan, then brings forth from its North Side the Body of Wisdom to be full in the South—from RAúwaben to BeniyMan, whereby all hidden in Dan becomes Visible. In this manner, a Man-Adam-Vapour brings forth from their left sides the ozar of Chaúwah/Eve—Mother of all activated in Seed, what is a living body to house what is expanding in Seed. Hereby, it is stated that the bone and the flesh are one body.

On Day 18 of DAN, then the Main Stalk of your 30 Numbers appears to Faces of Reshun, who causes Seed to spout green on the third day; hence, Father of Trees/Teachings of various paradigms/seasonal/kinds, bearing evidence to what is in Seed (SMB/Gen 1:11-12). The first stalk of Seed becomes the Vine of Zebúwlan that will bear the glories/weights of Yaoquv. What comes out of the waters of Ayshshur resound with green ears of Shamoúnn. *e.g.* Green ears appear days prior to Pessech as offerings of Shamoúnn rise on day 11 of Yahúdah (first moon); following thereafter, one makes preparations as to the house in which they will be transferred as they emerge from former boundaries/egypt (Yúwsphah/Lk 22:9-11; Metiyæhu/Matt 26:18). A Man that carries a pitcher of water, depicts the vessel of Ayshshur, which brings forth new states of appearance to enter; hence, never short change what you are carrying; all sown in your waters is destined to rise from your womb in your seasons. Every offering of ALhhim contributes to the saga of discovery; especially those of Ayshshur that initiate change unto an expanse of hearing in Shamoúnn. *Forming green/aviv ears is an alert that you will be coming to another house/body of teachings prepared to feast therein, as the result of green comes grain* (SYM/Ex 13:4; MT/Deut 16:1). Words in your SEEDareGREEN in comparison to dried leaves of the texts that must be reactivated by moistures of Breath. What you hear rising inwardly has a fresh ring (green) that brings you into further levels of HhaDavar/The Word. Vibratory Words and sub-atomic particles of SaturnofAyshshur and VenusofShamoúnn surround you as pivot points in your ascensions. The harvest is now in motion to be made full on Day 30. Days 18-19 bring to the fore, what is stored in your dwellings of Dan, to affirm all in active destiny through prophecies spoken in Ayshshur to be developed in Shamoúnn—with silver and gold.

#### COLOUR STREAMS OF THE SEVEN RAINBOW HILLS

The necessity of GREEN determines the outcome of all fruit which are in the broad sense, a state of being full, the abode of ALhhim Lights. As the central colour of the Seven HILLSofYEHU, one finds within their central vine the Lives of all Names, Master Reshun. The fruit that comes from the Vine is of Father Yaoquv. Within Green are the vibratory hues of darker green of Father ShmúwAL by which a Name is ever new (a new Name), and the springing

force of JOY of Father Yetschaq/Isaac that causes the tender shoot of bright green to come forth. At the apex of the Central Hills is the Name of Father Reshun, the Master of LIVES, from which comes all generations of Names to abide on two sides of the River of Zebúwan Oasis (Euphrates/Perut X 47) with green leaves (Ayuv/Job 8:8; Yirmeyahu/Jer 17:8; Tehillah/Ps 1:3; CHP/Num 24:6).

Though fields are whitened to harvest with tints of silver and gold, they contain the White Inner of Seed and Egg, yet underlying in all colours is the RED of Aharúwan, Invisible and Visible spectrums. Hence, when you eat the GRAIN of HhaDavar, you receive both the Body and the Blood of the rejuvenating OIL in Seed.

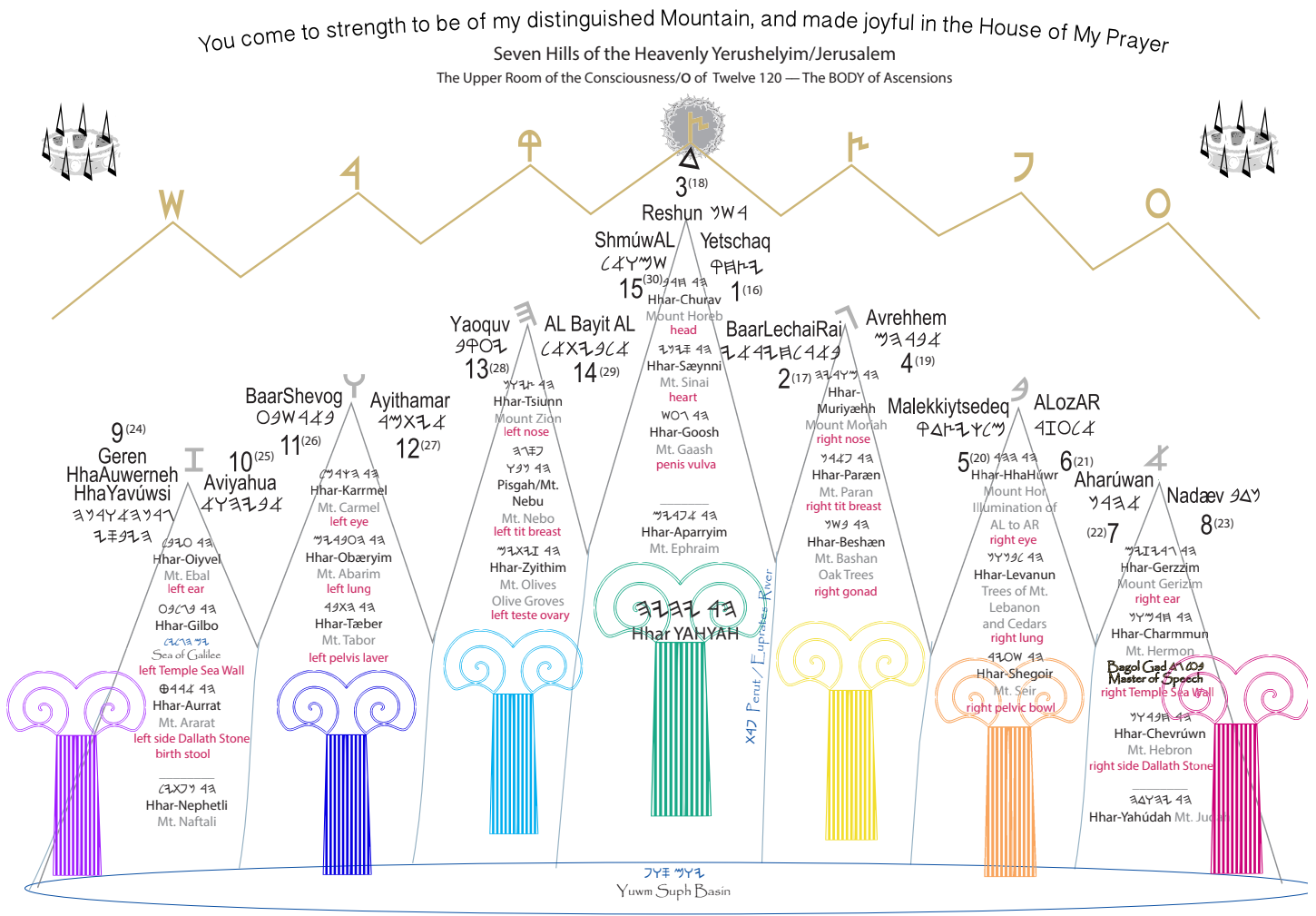

THE BODY OF ASCENSIONS

The Names of the 21 elevations of Fire W, upon the Mountain of Seven Hills, are transcriptions of the functions within the body. The ascent of SEED rises into body elevations which are referred to as hills and mounts (Tehillah 114). The waters that are rolled up for the collectiveness in your Name to go forth, as on dry land, are the waters of the womb/stomach which are piled/heaped-up for you to pass through as you make transitions into states of shavbet — to enter

destined residences. These piled up waters are noted in the above diagram as the left and right Temple Sea Walls of Ayshshur.

#### THE ALHHIM OF FIRE&WOOD

The 28 Names of ALhhim are categorized by evidential functions in the Body—a visible display of what is invisible. The Names of ALhhim are Word Clusters of 22 Signs/Letters. The ALhhim of Fathers are Shayin W and Semek 𐤌, the SpiritFire of Yæhuwah and the WoodBone/Teachings that contain Fire. Within the 15 Houses of the Fathers, the 28 ALhhim abide. These together form the OYIN (28/10+15/6) Rings of habitations and their Stars.

#### THE ALHHIM OF YEHU

×W4𐤑𐤏𐤓𐤕𐤌𐤎𐤏𐤐𐤑𐤒𐤓𐤔𐤕𐤖𐤗𐤘𐤙𐤚𐤛𐤜𐤝𐤞𐤟𐤠𐤡𐤢𐤣𐤤𐤥𐤦𐤧𐤨𐤩𐤪𐤫𐤬𐤭𐤮𐤯𐤰𐤱𐤲𐤳𐤴𐤵𐤶𐤷𐤸𐤹𐤺𐤻𐤼𐤽𐤾𐤿

The ALhhim form the House of the Fathers and their Mansions of GemStones. The ΔΔ ALhhim lay the foundation—the Everlasting Word Stone of DauwiD, in which all Names take refuge and abide in the domains of upright branches—the Kingdom of YishARAL. Within the Domains of Light are Gifts of the Fathers dispersed from their Faces to all born in Them to abide as OnePeople. The 𐤌 LammedYeuwd, legs and arms, that carry and serve all inhabitants bravely entering Mother are the ALhhim Gifts of Lauwi which forms the structure for all peoples, tongues and nations to abide peaceably together in their Fathers' House of Prayers/Supplications of Bread and Wine. The House is comprised of three divisions of Service: the Marri Bones of Semek, the Decorated Δ𐤗 Veils of Gershun, and the 12 Holy Vessels, 4 each of Gold, Silver, and Bronze are put into the care of 𐤑 Qahhath/Kohath, the nervous system complete which carries messages to the ends of the earthbody. These Vessels are the Body of Faces of Yehu in which the Bread of the Sanctuary is kneaded. As a result of the Grain gathered, oil and wine are stored in these vessels of honour. The vessels are emptied by offerings of free will givings in the Spirit of the Father whereby they can be refilled-renewed daily with a flow of Understanding. These Vessels hang as organs on the Vine of Zebúwlan of the 𐤏 ALhhim. The Vessels are distinguished by the ALhhim forming them for the resident Faces of Yehu. The eyes are of the ALhhim 𐤏𐤐; ears of 𐤑𐤒; facial cheeks of 𐤓 mouth 𐤔; bodytongue head tail 𐤕𐤖; endocrine labour system 𐤗𐤘; blessings of penis (narrow gate) and vulva (wide door) of the ALhhim 𐤙𐤚 𐤛𐤜 that forms a single eye—a narrow path of SEED HARVEST or a broad way of fleshly glories leading to destructions; the gonads of ALhhim 𐤙𐤚 𐤛𐤜 secure generations with Bread; the gamete ALhhim 𐤙𐤚 are forces of rotations and ascensions; the lungs W𐤛 of the Spirit Sanctifies all cells that carry its BREATH and BLOOD; the ALhhim of the stomach/womb are for transformations 𐤛𐤜; and the heart altar ΔΔ in which all Names are born, secures your Name from corruption in the Root of DauwiD (Tehillah/Psalm 16:9-11; 2 ShmúwAL/Sam 7:4-17). By the ALhhim of Yæhuwah one abides and functions in Temple duties ongoing night and day as above. The × Taúweh Head forms the capstone of the Temple Teraysarun. Implementations of the ALhhim are under administrations of the generations of Aharúwan, giver and keeper of Faces and their children. The ALhhim in all of your parts are the composite signs of Light that affirm that you are the Body/Temple of ALhhim, and belong to none other. The ALhhim hang upon the totem pole of Faces as AR AL.

Father Avrehhem, Day 19, supplies what is necessary to expand what is sown and appearing. Avrehhem is called “the Father of all Nations,” for when Seed opens and sprouts what follows are all the processes/nations/goyim of a Name collectively and interfacing with one another. By spinning SeedOil, Avrehhem is known as the Father who sends a Name—sets us in motion. The visions of Avrehhem foresee our being caught-up in processes unto the day of our liberation as we affirm that your Name belongs to the Two Lights of Hhúwa אא. The FatherForce of Avrehhem causes orbits to form and expand as EyeRings and supports the expansion of Understanding in the heart. Forces of Expansion are in the origins of Seed to increase and unfold with all of its inherent processes.

The ascent unto Churav/Horeb is where maShayh/moses encounters the burning bush—the inner branches setting abaze as the mind of holiness. The Head is the sanctified holy-ground, set apart from the body. In Túwrahh SYM/Ex 3:6, we receive an admonition of being in holy ground—in Churav, an ascendant place of the Fathers אאאא—lit. the Origins of Buds—Heads for Offspring born at their altars. As the buds break open the inner colours of Fire radiate but do not consume the branches supporting them. Your Fathers, אאאא, is of the root word, Father אא, a plural pronominal form. A corresponding term to fathers אאאא, is buds, which forms Head for Seed (see Pealim - Hebrew conjugation tables of אא). Fathers appear in assembled families/societal gatherings, whereby in One SEED are many Fathers. In vertebrae Beings, are multiple fruitor-gans of different kind of diversity and functions, hanging on the bones. The fruity organs are combined formularies of cohesive Faces of Fathers stored in a SeedCapsule. In comparison to a peach tree, where only one fruit hangs on its bones, 12 hang in the House of Laúwi. One may say, “One Father,” meaning that the 15 Fathers are Unified to abide in unbreakable covenants, Faces to Faces, in one House/Body; or one may say, “One God,” meaning that all 28 ALhhim are unified in Agreement communicating the Light of the Fathers in their Offspring.

Words uttered in Mount Churav are of the Anuki—The Voice of the Heart. The Heart is formed by the pairs of Faces: Avrehhem+Ayithamar—which speaks to the Lambs approaching the Head of the Mountain: (I am) Anuki of the ALhhim of your FATHERS. Churav is the elevation that the Fathers gather for sacrifice to declare Understandings of the Heart. By the Voice in the STONES of the אא Avrehhem ALhhim, by which all Names are sent into the world, the loin base of heart expands for the Head of Churav to appear; to be אא ALhhim who bind together the Faces from side to side as one, forming an everlasting strength of Joy—Yetschaq—the Faces of Father who abides at the side of ShmúwAL. Yetschaq receives your offering preparations with blessings upon the 1st and 16th days of a moon when you ascend to Churav. From the heart rises the אא ALhhim of Yaoquv, whose Faces of Glory shine on the Mountain of Churav as the Weights of Glories in Yaoquv are directly connected to the side of Reshun to bear Fruit/Words of Stones on the Vine. Here, in Churav, the Names of the Fathers of SEED JOY & FRUIT gather at the paramount of Head. Here are the Faces of Avrehhem—the expansion force of Seed, by blood pulsations, that form Head; Yaoquv, —the Head of the 12 of the Primary Vine and Branches of Reshun; and Yetschaq—the foundational reason of all sown to bring forth Head, that is, JOY.

## THE SEVEN PRIMARY FACES OF THE FATHERS IN YEHU

- 1 Yetschaq/Isaac, the foundational purpose of creations and stages of becoming, Father of Joy, the free giving that satisfies
- 2 BaarLechaiRai, Father of Everlasting Supply, the abundant resources to come to aide in all phases of transitions, states of becoming
- 3 ReShun, the first emergence of the Stalk at the level of Knowledge
- 4 Avrehhem, the expansion within the Seed House
- 5 Malekkiytsedeq, the alignment of all parts rising as a straight tree
- 6 ALozAR, the emergence of the Faces of Yehu radiates in the OyinZayin Body
- 7 Aharúwan, discourses of Knowledge as intercourses of supplication, founder of pairs, whereby Light abides in Wisdom of mutual impartial sides; the Number ratio foundation of Aharúwan is 2:2 (256/2:11/2) ㄥㄥ by which all appear and have pleasures of fellowship, establishing from Seed two trees on each side of the River, a compendium of Understanding with corresponding fruit of Knowledge

## AND ON THEIR SIDE ARE THE FACES OF UNDERSTANDING BY WHICH THE SEVEN PRIMARY APPEAR

- 15 ShmúwAL at the left side of Yetschaq, the Name of Fire and Water containing the impetus of Joys, the bond of the Invisible and Visible, together they are Oyin ○ 16
- 14 ALBayitAL houses the Faces of Yehu from which all blessings flow through BaarLechaiRai, together they are Oyin ○ 16
- 13 Yaoquv bears the weights of fruit that reveals the strength in the Stalk of Reshun, together they are Oyin ○ 16
- 12 Ayithamar fortifies the branches to reveal the ongoing expansions of the Seed of Avrehhem, together they are Oyin ○ 16
- 11 BaarShevoo, Father of Seven Wells, supplies the depths of the column/pillar for Malekkiytsedeq to rise as palm tree, together they are Oyin ○ 16
- 10 Aviyahua, Father of Becoming, pulses in the OyinZayin Body of Seven Eyes to shine as the Light in Paths of Ordination, revealing in stages the inherent Body of the Faces, together they are Oyin ○ 16
- 09 GerenHhaAuwernehHhaYavúwsi—the Mastery of Concealing, as tempered to release all held in the heart, and as one stricken, whereby the Light of Father Aharúwan shines forth from Olde, together they are Oyin ○ 16

## IN FATHER NADÆV ARE THE DOUBLE EIGHTS ∞ OF ETERNITIES ㄥㄥ

- 08 Nadæv, who abides in their foundational midst of Yehu, is the Force of SEED Generation, Determining Rotations, and Causing Elevations through descensions and ascensions in the sub region gonads that define the Nose of Dan central in its Faces, from both sides, together they are Oyin ○ 16.

## GETTING TO THE HEART OF COLOR

The Days of Avrehhem commence the final third section of a moon cycle. Days 19 to 28 spin by the 10 Numbers of Knowledge of your Name to establish the resident state of shavbet for your soul members. Plot your 10 Numbers of Knowledge on a luæch/tablet to focus on interactions of your Numbers with the Faces of Days.

**Formulations of Light into embodiments are by Colour Vibratory Waves assembling to happily abide together.** The Body is formed by the Breath of Dan compiling strands of colours through four offspring of Nephethi: *YachtsAL, Gúwni, Yatsaor and Shallam* (CHP/Num 26:48-50). **As Vapour swirls amongst Rays of Light, a Spirit compiles threads of Light for its habitation.** In this manner, bodies, as houses of the Lights, are created by Dan for a Name. Words of ALhhim then assemble the strands of colours in the  $\Delta\Delta$  Stone of Dauwyd which appear from bone and blood with their coats. The results of the combination of colours comes forth as OIL is spun in Seed of the Fathers, whereby it is said that the Anointing Oil/Christ is the Head/com-mencement of all things appear as patterns of crystals—Visible Bodies of Invisible Breaths. So then, *The Question* comes: **How does a Spirit take on one form or another?** *The Answer* to this probe is that the form appearing is based on the ascension level of the Spirit to connect to Colour Waves of ALhhim, as Vapours to Vapours spiral together into SeedStrands. As a Spirit is aligned and bonded to Yehu, through agreements/covenants, the type/kind of House/Body is drawn out of the Seed in which a Spirit dwells. “Graduations” or variations in dwellings are based upon Spirit to Spirit agreements with the Words of ALhhim in an Invisible State by which a Name is able to make itself Visible according to its agreements.

The Ten Days appointed by Avrehhem is the basis of the transcriptions, that “Avrehhem pays tithes”—the tenth portion to Malekkiytsedeq/Melchizedek. What flows from SeedExpansions in Avrehhem are Gifts of Knowledge transferred for masteries/alignments in the Hands of Malekkiytsedeq.

#### THE TEN DAYS OF KNOWLEDGE IN DAN MOON

- 19/1 I’Avrehhem
- 20/2 I’Malekkiytsedeq
- 21/3 I’ALozAR
- 22/4 I’Aharuwan
- 23/5 I’Nadæv
- 24/6 I’GerenHhaAuwernehHhaYevuwsu
- 25/7 I’Aviyahua
- 26/8 I’BaarShevoo
- 27/9 I’Ayithamar
- 28/10 I’Yaoquv

#### RESULTS OF ASCENSIONS

- 29/11 I’ALBayitAL; A shavbet residence of your  $\Upsilon$  branches built and entered
- 30/12 I’ ShmúwAL; A culmination of instruction  $\zeta$  embodied and carried forward in a Name

#### 15 DAY INTERVALS

Malekkiytsedeq advances from Day 5 to Day 20 in Days of YæHH. The 15 day intervals of Faces are laced from what is given to what is received. What Wisdom reveals in Days 1-15 is gathered in the hearts of Understanding in Days 16-30.



## THE LAST DAYS

Days 20-21 are accomplished by offerings of Nephethli and Gad in DAN, in which Words of Knowledge form on the lips that complete and fill your dwellings unto the Last Day—the Tauweh/22. Commencing with Day 22/X there are seven last days (23-30), whereby they are called “the Last Days.”

Days 22-24 release the blessings of the Numbers by offerings of Yahúdah by offerings of Aparryim. By these ascension offering your Name is appointed unto its sequel resting place/shavbet of ascension as grain forms on a stalk. As a result, a new dwelling of Spirit is carved from your StoneSeed to reside above. Transferences of Name are made by activities of ALhhim unfolding within Seed.

Days 25-26, the composite Seed of Dan, formed in three sets of seven days (1-22), now is elevated by offerings of Yishshakkar and Maneshayh for paradigm shifts to enter corresponding residences. Change of residence equates to elevation of Seed. In the last days of the Days of Dan, on Days 27-28, a renewed residence of many mansions has been prepared by the ascent of your Vine forming a Harvest Head of Seed gathered by Dan, the Judge.

Upon your appearing to the Faces, being in one accord, the chaff (former bodyofremembrances) is burnt by the Fires of Angels in Dan, and the Golden Grain clusters of your Name are gathered to abide with those ascending with the Fathers. You enter into your combined state of shavbet residence on Day 29. The inner Voices of the Fathers and their ALhhim, the Heads of the Branches and their generations, blend harmoniously to transmit the messages of your Name through intervals of sound waves. Within you are heard multiple Voices of the Fathers and their ALhhim in the Voice of your Name as you speak Words of ALhhim and sing with all Voices as one. The Words we say are resonance sounds within our multitude of waters. As depicted in the Vision of Chazun/Revelations: And I hear as A VOICE of a great crowd, and as A VOICE of many waters, and as A VOICE of strong thunders, saying, HalleluYah, for YæHúWaH of our ALhhim, the almighty alignment of Faces asserts kingly power/authority from within us. This Voice is heard from your Name carrying all attributes of the Fathers spoken from your Seed.

In the 30th Day you appear in your fullness having attained the Lammed/ℓ of three Yeúwd/𐤀𐤁𐤅 of **three works of Light: to conceal, to reveal, and to put-on Heads of glories.** The weight of your glories creates a heavy darkness. Your lamb offerings of Dan become a LampBody that is filled with the Lights of Wisdom and Understanding rising from your SeedName, filling the two sides of your Temple, and in your Head are massive Stars. The DARK TEMPLE is where you come to abide as the layers of Light colours are drawn out from your Seed. Layers of colours upon colours that are woven into garments, creates a black house. No longer will the sun be needed as your light by day; nor the brightness of the moon to shine on you at night; for YHWH, your inner Collective is your everlasting beaming Light, and your ALhhim of Words, your splendor illuminating all within your compendium of Seed. The Dark Temple formed is as the cloud of darkness that houses YishARAL in midnight and brings them out of developing habitations to their destinations of OLDE. Having been born from Darkness one now returns to Tsiunn/Zion (North Dark Side of the Hills) with full knowledge of their origins. When the ALhhim say, “And YæHH gives Light” (let there be Light), it means that the Faces

housed in Darkness are being given/revealed without reservation to generate Offspring to enter into their Darkness; by which they build and fill their Houses with Gifts. In this giving there is no duality of good and evil. All is spoken and seen to be Good—for the Collective habitation of all Names. The Darkness and the Light are One. What is given from Darkness will return to abide in the Secret Dwellings of Darkness.

Your Body Temple is filled with Lights of the 15 Fathers from their two sides of habitations. Their Faces appear and are emitted in your offerings from their corresponding activated chambers. Being the composition of SEED, the Lights of Wisdom and Understanding rise from your ThroneChair of DæúwD to form Crowns of Knowledge. The stardust in SEED rising forms a circle of stars around your head.

Tracking your days corresponds to the 30 Core Numbers of Yahúdah in your Name from which the OIL in SEED flows. Your SEEDNAME spins amongst Rings of Stars that the moon enters for two or three days as a camping place. A Bayinah enters into a camp, She designates that sphere to bring forth its offering in those days. By the Spirit of Dan, causing an ascent of the OIL/Anointing in Seed, one moves within rotations, keep pace and rising with the moon. States of your ascensions correspond to your 30 Numbers as they are employed in the daily offerings. Ten Numbers are days of Wisdom, Ten for Understanding and Ten Numbers for Knowledge in a month. Numbers of your Foundations are in the roots of your tree that seep; your branches extend by your Numbers of Understanding that flow, and Heads fill-up by your Numbers of Knowledge appearing as a harvest each month on your Branches that are in unity with the Elders of your Houses. The culmination of your days of ascending provide the weight of evidence to judge yourself by Wisdom, Understanding and Knowledge, at “the impartial Judgment Seat of meShiæch”—in which you bear testimonies and affirmations of your head being anointed with Oil Rising to the Crown.

Intentions of the Yehu FATHERS are abundantly evident to Give all they are to their offspring FREELY, whereby JOY comes with the sowing of your Seed to be ever present springing up within you. Nothing surpasses the Freedom to Give, to Bless, to ExpandSeed, to Harvest your pure Names as IT rises from being sown. In coming to the YarrDenn/JorDAN, you judge yourself to be one with your foundational SOURCE.

The 30 Numbers of Name are the structures for your Tree of Lives woven from both sides of the River of Name, running centre in the midst of days 1-15—15-30. The spokes in the wheel of Days and Numbers connect your Name with the Faces set from side to side in 15 day intervals. The Faces rise within your 12 as they come to the altar to make their ascensions. **The first 10 Numbers extract Wisdom from the Seed, as bursts of energy for the Tree to go down, take root,** and subsequently feed the root level of your Trees as well as further broaden the roots to support the core of the Trees to bear their Fruit of Knowledge year after year. The Light of the moon’s first days are dedicated to Wisdom and correspond to your 10 root Numbers of Wisdom. For each moon cycle of renewing Trees, the 30 Numbers of your Name are the means for your 12 Trees to become green—renewed unto a harvest.

## 12 TREES RENEWED TO BE EVER GREEN (AYUV/JOB 42:17, TEHILLAH 1:3)

Accounts of the TWELVE that follow Yahushúo are personified stories of the 12 in us. They come after and appear as OIL flows from the SEED that rises and appears within the WaterBody of Mother. Looking within, anatomically, we see 12 primary organ systems abiding in a unified structure of bones, nerves and skins—the House of Laúwi. As the Voice of Wisdom and Understanding rises in us, IT calls out the 12 unto their studies and to be envoys of the Master plan. Your Spirit of Dan is the Teacher of your 12 within to guide and lead them to your Unity with the Fathers. As OILinSEED rises and flows within your parts, the Sheep of your Name are fed and led in Paths of Wisdom and Understanding. Names of the 12 learners of your House, follow the path of SeedOil to the Fathers. Your Name calls your 12 as you see them standing idle or caught in nets of the sea/womb to be employed in the network of their Fathers' Enterprise. The Names in the literature of the Essenes illustrate the minds of Knowledge to contain the revelation of the Branches of Yaoquv. The art of Oovri/Hebrew writings presents word pictures to heighten themes of realities for those in quest of ascending above the mundane world (Mishle/Proverbs 25:2).

*“It is the glory of ALhhim to conceal the Word,  
and the glory of kings to search out the speech.”*

The Twelve are sons of glory—Yaoquv upon whose tree is born their crowning sister, Dinah—the Judge of YæHH. Sons are FORMULATIONS of the SEED of the Fathers. They come forth by Faith of the Fathers which makes the Invisible Nature of ALHHIM to be visible in our current or former/fire/vapour or subsequent forms. The abiding in the House of Laúwi is to comprehend the intricacies of the glories of WHO we truly are in or apart from the veils. With Faith of the Fathers, we hold on to the HOPE of ALhhim within us, because we know, by the Knowledge in our SEED that forms of fulfillment will arrive, transpire and transform, by the steadfast bonds of Love developing the ALhhim Soul within a cocoon body.

OFFERINGS OF YOUR TWELVE, BY YOUR NUMBERS, ARE SET TO THE FACES OF YEHU  
ASSOCIATED NAMES OF THE INNER TWELVE FOLLOWING AFTER YOUR OILLIGHT WITH YOUR BRANCHES OF SEED

1. The Branch of **Shamoúnn/Simeon** (hearing function) is the disciple **Kayphah/Peter**, the foundation stone of hearing. With understanding of origins the House of a Name is built. *e.g.* Names of paired branches come from two sides of a Seed that are comprised of two Faces of Yehu, whereby Fathers of Shamoúnn are Malekkiytsedeg (left ear) and BaarShevoo (right ear).

2. **Andrew** is disciple of unity that upholds his brother, Aharúwan/Aaron, representing the Branch Brother of **Laúwi/Levi** who upholds Shamoúnn in **Ayshshur** (the womb, sea of passing). What is heard is set as stones upon stones to build the Temple on solidarity of realities (SMB/Genesis 49:5). The Letters, dr in Andrew, are both symbols of the Rayish. Aner has a mind of Neuwn who upholds the Temple built without hands. The rendering of the Name is with an Egyptian influence from the waters of the Sea of Reeds/Womb of Ayshshur as the brother who upholds all in Seed. As the counter part to Shamoúnn, the Fathers of Ayshshur are BaarShevoo (left side) and Malekkiytsedeg (right wall of the womb).

3. **Yaoquv/James of Zebúwlan** is the branch of the Vine upon which word-fruit hang upon the dangling tongue of the coiled serpent (entrails). The narratives of the 12 connect directly with the 12 Branches of Seed and called unto their services as vessels of ALhhim. Fathers of

the Vine are Reshun (left side force of emergence) and Yaoquv (the right of the Vine upon which 12 heavy fruit hang).

4. **Yahuchannan/John**, brother of Yaoquv, upholds the serpent in **Beniyman** (the gamete), to be the tail and head of Zebúwlan. The Grace of Yahuchannan flows abundantly from the ChayitNeuwn ALhhim that form SEED, who are ever generous with provisional grain sacs for Beniyman/Benjamin by the Hands of GerenHhaAuwernehHhaYavúwsi who causes Seed to break forth from within chaff and shell in which the Light of Father Aharúwan abides forever.

5. **Philip** represents the Branch of **Gad** as the mouth of the Staff, carrying the Letters of PaúWah Lammed PaúWah. The Name associates with Pinchas who provides instructions through Sayings. The Fathers of ALozAR and Aviyahua form the left and right cheeks respectfully in which the spirit regulates the Breath to speak from the composite dwelling ALhhim.

6. **Bar-Tholomew**, son of Talmai—lit. one of the furrows of **NetenAL/Nathaniel** is of the heart Branch of **Nephetli**, providing deep cultivations of words and meanings. In the Gate of DæuWD/David, the Fathers Ayithamar and Avrehhem appear that make strong the heart and cause it to expand with Words of Túwrahh.

7. **Thomas/Toma** is a twin, from Aramaic, and also known as **Didymus**, Greek for Twin, conveys the Blessings of **Yúwsphah's Aparryim** (appointments and distributions of grain) who bears the twins/pairs of SeedRock of **DæúwD**. Fathers of Blessings and their revelations form the rule of Yúwsphah to disperse Seed to all generations by the abiding Hands of the Faces/Forces of Aharúwan and GerenHhaAuwernehHhaYavúwsi.

8. **Metiyæhu/Matthew**, the tax collector, is the branch of **Yahúdah** (regulating codes), one gifted with calculations/Numbers and their computations. The 12 are distinguished to personify many disciples (Menachem/Mk 2:15). The invisible and invincible codes of the Fathers abide in anatomies of regeneration and monitoring systems by Hands of ShmúwAL and Yetschaq.

9. **James Yaoquv Bann ALphah** corresponds to the Branch of **RAúwaben**, head of sight of the ZayinALphah ALhhim. As a wolf leaps out of Beniyman, Alphaeus of Clopus is the seeing function rising out of Seed to behold its glories. Born of Fathers Avrehhem and Ayithamar, the Eyes expand and encircle the core Semek bones of Yehu. Though you are sent on a far journey, the Fathers are ever present with you abiding in your habitations. For how can the branches abide unless the SEEDFORCES of FACES are within them?

10. **Thaddeus** is of the breast chamber, denoting praiseful contemplations, a discerner of Values, of enduring generations that corresponds to the givings of the Tenth Branch of **DAN** (chamber of lungs/judgement). Fathers of lungs, on the left is Aviyahua, and on the right, ALozAR. Together they administer the Breath abiding in their Rings and states of habitations.

11. **Shamóunn, the Kenoni**, a zealot of the Branch of **Maneshayh** (source of Seed formations/perpetual harvesting, gonads), the source of blessings, healings and perpetual branching. In residence are the combined Fathers of Nadæv-Nadæv of the free giving Spirit propelling generations and their ascensions.

12. **Yahúdah/Judah** of Iscariot is the Branch of **Yishshakkar/Issachar** (endocrine distribution of labours) who returns pseudo silver/understanding of former teachings and then hangs himself upon the Tree Skeleton, as the Ascendant Numbers rise with the OIL from Maneshayh. Fathers of abundant supply, BaarLechaiRai and ALBayitAL make up the glands of labour weaving the leaves of your spirit according to your labours. Learnings and consciousness developments concur from the Centre of Kerioth, a city in Yahúdah (Yahushúo/Josh 15:25) as Yishshakkar is the Body of Understanding for the Wisdom in Yahúdah.

These 12 of your STONESEED float in the Waters of **Ayshshur**/Asher. The bringing of your 12 to the altar evening and morning aligns with the Names of ALhhim of whom your 12 are born for dwellings of the Faces of Yehu, concealed/honoured/cherished within. The Lammed Numbers of your 12 rise with the Master Lammed Numbers of your Name. As the Oil in your Name rises daily, the Numbers of the 30 days in a moon correlate to the 30 Numbers in your Seed to govern your nights and days. The Oil is a composite issuance of Numbers in Yahúdah. Together with the Oil, your Numbers of Name rise to be paramount in your ascension offerings, which no man can see nor hinder. Above all else, as Kings of Yahudim Codes, you will see your Numbers of Name at the apex crown in your offerings which are able to succor, save, restore, and reconfigure your branches unto their glorious destines (Yeshoyahu/Is 11:1-10, Yahuchannan 4:22).

**The second set of 10's (days 11-20) are the darkest days of the moon** corresponding to the Darkness of Bayinah, five days on the right and 5 days on the left, which extend Wisdom unto Knowledge, the purpose of your givings to bear a harvest<sub>of</sub>Seed—thus, an increase of your Star(s). Your 10 Numbers of Understanding are the largest Numbers of your Name which contain the wealth and vast depths of insights to stabilize your Name's growth and productivity. Through Understanding, Joys of the Seed giving and opening are sustained from its root level. The process of the growth and blessings of your Name are as in the parable of the Sower of SEED, First, the seed sprouts; then it produces a stalk and leaves, then a head of grain, unto fully developed kernels in the head (Menachem/Mark 4:26-29). Each generation of your Numbers corresponds to messages of angels that abide in your branches, inherently, always present, but appearing as you grow. During your days of growth, messages in your Seed come forth to your wonderments, as no man told you these words that come on your lips.

In the midst of the days of Darkness you come to the 14th evening into the 15th day. With the 10 Days of Wisdom depositing their colours of Light, night and day x ten, with a mix of the first half of the Days of Understanding x five, the Night of your Name comes for you to be born. Hence, on this night you emerge at Pessech, a night to be recalled in all generations from which you pursue the riches of gold and silver deposited in your Seed, by which, you bring forth the 12 Heads of Grain upon your stalks.

**The third set of days in a moon are the Days 21-30**, which form Buds and then the Heads<sub>of</sub>Seed of your Name in each house. In these 10 days, you commence to grow in brilliance unto your Heads become full of Wisdom and Understanding, the Anointing of OIL of Yahushúo, bearing the glories/weighted fruit of your Names to which the sources and the branches are heavy to bow down to Yúwsphah/Joseph.

*Connecting your Numbers from the two sides of days* provides formularies of Yahúdah to appear through Aparryim. Numbers join as the Faces of Yehu appearing in 15 day intervals, whereby the Light of Wisdom/sun and the Light of Bayinah/moon form a bodies and heads of Yahushúo in the days of your ascension. As in the chart above, day 20, the culmination of activating your 10th Number of Understanding, is joined to the 5th day of Chækúwmah resulting in a return investment of Wisdom unto the banque of Understanding. What is given as Wisdom in

days 1-5 returns to its Source of Understanding. e.g. Day 5 (Values 240) is absorbed into Day 20 (Values 2640) resulting in a sum substance of 2880 7אז, the Sayings.<sup>80</sup> of ALhhim.<sup>28</sup> The remainder of Wisdom given in days 6-10, supplies the newly forming Heads of Knowledge in days 21-25. The final days of a moon culminate with the sums of Understanding, Days 11-15, brightening the Heads of Knowledge in their days of 26-30.

During an offering, the Numbers of a Day ride high, within the ascending OIL, above the waters. As a state appears by its Numbers, branches of the offerings ascend into smoke rings on the Mountain into Faces of Aharúwan. During the oylah offering one may appropriate the measure of the Light in their 30 Numbers together with the ascensions of the branches that are freely giving their strength for the House in its season/month. Each day, your Tree changes as it leafs, branches and buds with heads. Each Number of Name is a frequency and wave that emits patterns/shapes of the Trees corresponding to the type of Trees in your SEEDNAME.

As FREQUENCIES, the 30 Numbers are levels of the same frequency of your Light during the 10 days of each set of the Lights assembled in your SEED. Using the Example in the Leaves of DAN, Day 1 is the manifestation of the Numbers of 48/12/3, Day 11 is 264/12/3, and day 21 is 3. The power of 3's evolve to the 10th power during the month. The summation of our Numbers correspond to the Number of the Schools of ALhhim with which we abide, as fishes, we abide in certain schools by our branded Number. Those with the summation of the Numbers of Three's belong of the School of Huyd, of the ALhhim of illuminations, states of splendors.

The summations of 30 Numbers in the Name of e.g. Yarrdenn/48/12/3 are mantras of 48, 264, and 3. The 10 Numbers of Wisdom contain what is given by Understanding's tenth power: 2640 (sum of the 10 intervals of 48=2640.) In the example above, Ten Numbers of Understanding range from 264 — 2640 which are the sum of 14521, the 10 (145) of 3 (21). The Ten of Knowledge are 3 to 30, the sum of 165/12/3, the Unity/6 of the Faces of Yehu/15, forces of Ascensions/Emergence, which this exemplary NAME serves as a POLE to cause ascensions and uphold them. The sum of the 30 Numbers are 17326, the cohesive force of 1. This is a brief read within a comprehensive review of 30 Numbers of a Name.

The route of a Name proceeds as the Breath of Dan activates movements in your Camp of Yahúdah that determine places that your Name appears; then the path widens by the Camps of RAúwaben to behold the WordStates opening as pastures fields; followed by the orchestrations of the House of Yúwsphah for cultivations of your Seed unto its lodgings. Then, upon the heels of all that rises in the third movement, with Beniyman (CHP/Numbers 2:24-25), the Camps of DAN come forth and gather the harvest of what is sown unto the Fathers.

#### DAN QUESTIONS THE WOMAN/ASHAYH/THE BODY OF THE LAMB

In the Garden of OoDAN/Eden, composed of trees and its fruit, the Serpent of Dan questions the Woman... do you comprehend what I have spoken to you concerning the Fruit that you are bearing within your Body? This question is a precursor to the Breath judging itself by the Body it has been given to abide within. The forming of Body/Chaúwah/Eve and its trees are by drawing out first levels of the gifts of Wisdom. In order that the Breath is not locked within woman, nor to abide in the lust of the eyes and the arrogance of flesh, the Serpent of Dan undermines the errors of perceptions of the Trees and its Fruit for the sake of righteousness.

Names are stones in terrestrial bodies, whereby we are not to deceive ourselves that we are immortals. This concern is the prompt alert for the Question that Dan asks Chaúwah/Eve to contemplate. The question comes from the embodied Serpent tongue within the Body of Adim to examine and yes, to undermine what the Serpent sees in her lustful eyes to be Immortal. Rather, the Spirit of our Names is called to build a House for the Immortal Presences/Faces. Should we give, willingly and freely, all within us for this House, then we set-up all aspects of the natural for the spiritual realities that it shadows; and if not, by holding back what is generated in us, we remain yet in process to entertain possible avenues of mysteries. The body is “Luciferian” when it thinks that it will abide forever in its form which commits wars/conflicts against YHWH in the midst of NAMES/Heavens who are coming into Mother to become STONES of Habitations for The Immortal. The war ends when the Spirit is content to be what IT is being fashioned as crystals on the potter’s wheel of universal circles. The term, IMMORTALS, conveys that we are not Mortals composed of the Dust<sub>of</sub>Stars to form dwellings of Wisdom and Understanding.

The Building of LAÚWI is for ONE who is IMMORTAL. It is an esteemed honour of a NameStone to be an alchemist to transfer Crystals of Breath to become polished Stones for Their Temple, proving to be bonded to others in love, seeking the good of all, whereby walls thereof cannot be torn down. When one Stone adheres to another with all heart soul and energy then that Name is suited to be part of the fabrique, woven strands to strands of AL, to be hung upon the bones/stalwarts of the Temple Enterprise, Fathers’ Business.

As the BUILDING and FORMS of ALHHIM, by Yahúdah and Dan, we are continually in transformation, according to the LIVING WORDS breathed into us and activated, being mouths to mouths of ALhhim. The ALHHIM<sub>of</sub>Words BREATHES into us the Spirit of DAN, whereby we become *living souls of stones*. The Breath of ALhhim contains the Words of Lives in SEED in which the powers of Ascension to create dwellings for Immortal Light of Aharúwan. As holders of SEED proliferations in seasonal formulations, we share freely for upbuilding the Temple Body. All the days of the Earth, seedtime and harvest, cold and heat, summer and winter, night and day, shall not cease whereby dwellings of Names are continually being generated and renewed (SMB/Gen 8:22).

Questions of DAN concerning SEED and its Houses as Fruit, rise concerning its distribution, placement, with a sense of IT being the BREAD<sub>of</sub>ALhhim—the Logo Word of YHWH. Who is the caretaker to cultivate the Lives<sub>of</sub>Faces within SEED, and dress the CHILD by spinning the OIL/meShich? Self-judgments are answered by what a NAME aspires to become by judging ITSELF in the EYES of ALhhim through reflective processes of coming *into* woman/manifestations.

Voices of Wisdom and Understanding speak from two sides of the Faces of Yehu. Wisdom and Understanding are the Voice of Yahushúo that communicates the WILL of the Father. Sons come from the Father as the Body comes from SEED, whereby messages within the Son/Body is the TRUTH heard voiced from within. Hence, the WILL of the FATHER is always present to be communicated with utterances to be understood insightfully.

FATHERS of Wisdom and Understanding are the Names of Yehu adhering to one another, from the dark/left and the light/right sides of habitations. These abide the same throughout AGES. Their FACES are revealed to us from within our inward parts by which they are formed to house the Lights.

The Dark Concealed side of Light already is full of Illuminations, as Light makes Darkness; however, when the Seven Pillars of Wisdom speak to their corresponding Columns of Understanding there is a complete House Structure built with the Teachings/Wood of Lebanon/whitenings. As both sides are fully activated, you are known as becoming “Perfect.” When the display of Wisdom accepts Understanding, then the Fire burns freely from side to side, whereby darkness is not pinched off, as hidden, from abiding in what She has given freely. This is the same message, that I come to my OWN, but the children do not know/recognize their Fathers (Malachi 4:5-6).

The language of SEED being “half baked” is the side of Wisdom/hot but the side of Understanding is yet concealed/cold. Hence, to be PERFECT, both sides of your Name come to abide as one kingdom/domain, Faces to Faces. Wisdom, right-light side, by which all is made, connects/returns to abide according to Understanding, left-dark side, by which all is given.

The veil between the two sides secures inner revelations of becoming. As the body is a drawn side of Seed, opening the body with the knife/penetrated tongue-mouth allows BREATH to enter as the Teacher into the Body for explorations of judgments. The BREATH enters directly into inter-courses of Wisdom to Understanding as the Spirit of DAN converses with the Spirits of the Fathers. At this level of communications, the Invisible Light Sources converse with what is made Visible. Communications transpiring are therefore above the world, described as intimacy with ALhhim.

The Revelations by DAN are direct and obvious. When you observe a tree, the tree wood and its fruit/peach contain Invisible patterns of its seed (though you crack open an almond or even a semen, under the scope, you do not see all lives contained within its whiteness); however, when it gives of itself, then it appears day by day in its season. Knowing what is within comes when the lip/mouth/tongue/sword-knife opens the skin/veil of the fruit, whereby the woven fibres of the fruit release the sweetness or bitterness of information of what the seeded-fruitbody is holding.

Hence, with CERTAINTIES, the revelation of ALhhim comes forth and is within MAN. What is inspired by the SPIRIT~~o~~f/DAN is written within your scrolls—rolled up body tissues, whereby all details written in your parts are profitable for establishing realities of Yehu, teachings, corrections, unto becoming upright/right standing as your Tree rises from the compound single Eye in Seed. Your Seven Eyes are in One Seed. Prophecies/revelations come not by the will of flesh but by the will of spirit to know and declare what is carried forward in flesh/appearances, whereby your Spirit of Dan judges and knows by Intelligences that which they are of and one with the Fathers. If what is penned in papyri scrolls would suffice it would not be necessary to send a SON to reveal the Fathers as **THE INTERPRETATION** of what the scribes wrote. Most fragments of discourses of Yahushúo are regarding what the Túwrah



Scrolls say about the Children of Avrehhem—those who are appearing for an expansion of StarSeed to reveal mysteries of ALhhim. Hereby, YOU, coming and appearing are the means of discerning and fulfilling what is written concerning your SeedName.

The WILL of the FATHERS is made very evident and expounded upon in scripts. The Fathers GIVE all by which their HOUSES are built for every Branch (Bayit DHY/2 Chronicles 35:4). The givings are of NaDæV, meaning of free will, whose hearts stir and whose spirit prompts them, verses other motives. To Give what you are Given (not stuff made by another), but what the ALhhim have given your freely that can be received freely by another. When what you give IS RECEIVED and held to be precious by another, then a BOND forms. When the Receiver gives in return and it is honoured, the Cord thickens. By the giving and receiving one to another a HOUSE is formed in the Name of the GIVERS: YæHuwaH.

Through offerings of Zebúwlan and Benyiman in the House of DAN, it is heard that the SEED has given from its right side of Wisdom to appear through waters of Mother, to show its mutuality of Faces of the Fathers, but has yet to give all from its left side of Understanding to know and to enter into its full domain/kingdom of Names united. When one seeks to know their totality, then they commence to follow Scripted Orders put in their hearts and hands. While one learns and keeps what is written by the scribes, one yet ponders their accumulated wealth, “All these I have kept.” “What do I still lack?” Yahushúo says, “If you want to be perfect (complete with both sides, exhilarated with the Joy of the Fathers), go, sell your possessions (what you have been given by ALhhim, not referring to stuff with images of men on coins or things made by men, and give to the poor—The Fathers who have given all, and you will have your SeedDeposits expanded into a treasure in heavens/Names verses in perishable flesh. Then come, follow the Faces of the Fathers—into paths of Wisdom and Understanding ever rotating and revolving, forming bonds in new worlds.”

#### JUDGE YOURSELF

#### EDITED CONVERSATIONS OF THE LAÚWI SIX

To love mercy, do justly, and walk humbly with your ALhhim are three measures to say and read. We enter into WORDS as our habitations; there is something off kilter when master-Servants are recorded to speak otherwise. Silver skies of Rain and Golden rays of Sun are given freely to the aligned/awakened upright man and equal shares to the slumbering who has yet to awaken. Is there a difference in the eyes of ALhhim to favour one more than the other when they are both children predestined with goodness? How can one call good evil and be justified to do so lest arrogance has been bred in them to deem oneself more important than another? Hatred of sects is conveyed in the text without mercies by religious men holding in their hands a frequency of words to promote superiority of self-standing in their own eyes, and to think, audaciously, that they quote “christ” with intonations of disgust and exclusion of others who are all born of ABreHHem—who come into the world for the expansion of their Names. When you exclude another from the Fold, you assert yourself-apart from the whole of the GrandeHaus.

## COMMENTS

ZekkarYahu: Revisiting the discussion concerning strategies of monitoring thoughts and the positions in family as means of evaluating, this would be in the term Mishpat, the word for family and also means to judge/evaluate?

Cheresti: I have been meditating on how the numbers are to be primary in judgment/Dan preventing the entanglement of the perception...in contrast to popular thought that One is to be judged by expressive action.

*Concur. Numbers are foundations of form, without being compromised, serving but not bound, limitless, enabling transitions, whereby our Houses are called by Names of their Numbers. CHP/Num 26. Numbers, are the crystals in BREATH, by which parts appear.*

Cheresti: Drawing all parts into One Narrative. Could you please give a brief perspective on judgment?

When my daughter, Dinah, was born, Yahúdah, a friend and neighbor had a dream in the night of her being carried down a ladder by two messengers. In the morning when she broke the waters, I was laying on the bed with her my arms and seen her Name composed as a weaving of ancient script. The Letters of two names, YAH and DAN were interwoven, א י ד ד—Dinah. Prior to Yahúdah ben Aharúwan relating to me the dream, I seen also 2 messengers that had come with her. The Name of these attendees are DaniAL on the left and Yehuwshaphet/Jehoshaphat on the right, left and right messengers of Judgements.

Hence, these Two Messengers abode on my left and right, for many years, as they remained in our house. Judgement in both on the right and also on the left, to judge what appears and to discern what is invisible. In short, I gleaned that judgments are affirming realities of the Word. At Pessech one year, we were reading how the ALhhim of Metsryim were judged that night, and it suddenly dawned on me that this was not a condemnation of any sort, but that the ALhhim within all parts/houses are seen, thereby rightly judged in knowing how we are defined unto freedom. In recognizing the Presence of ALhhim, we are able to ascend through forms by aligning with the inward Word patterns that comprise our houses unto liberties.

The base things of the world, and the things that are contemptible, hath the ALhhim chosen to abide within, as well as in things that are not—those Invisible attributes of the Faces, that they may bring to naught things that are perishing. What is visible is brought to the source from which they appear even in a flash or glimpse of time, whereby no flesh glories in its own accord. Upon having these perceptions of ALhhim in all things, we judge rightly the glory of the ALhhim taking resident with us whereby we are not servants of the flesh, but of the ALhhim who are in flesh, abiding there as in a cocoon until we are winged to emerge. And of them—the ALhhim— that make up the Body, you abide in the Anointing of Seed, risen from the loins to the crown (steady daily ascensions) of Yahushúo, who is of ALhhim, appearing in us by the ALhhim of Wisdom, and Justice, and Sanctification, and Redemption, whereby we dwell above corruption, making a transition through what appears to abide in the logo Word of

ALhhim—the summation of that which is in the Body of Wisdom and Understanding—Yahushúo (the great culminating, summations of on-going ascensions).

**To judge is to see clearly without partiality what is, within and without, a discernment that comes by alignments with the ALhhim.** *When you judge a person by the outward state, or distinctions of colour, gender, size, wealth or poverty, then you are weighing reflections but not the ALhhim themselves. When you no longer accept the judgement of others to over-ride your decisions and actions, then you have the strength and fortitude to JUDGE YOURSELF.*

Meqray: Your words reflect Isaiah 59:9/11 (the entire chapter as a whole) Judgement is a positive not condemnation: “Judgement is far from us; we are expecting light and get darkness.” “We are expecting judgement, but there is no salvation.”

*In our Breath and Bodies are tight weavings in the Amazing SEED of the Kuwáhnim in Yehu and their ALhhim, whereby Names are able to abide as Vapours, Vertebrae species, and Victorious Offspring of Darkness to Light and Light to Darkness. In Spirit and in Body we are honoured to walk in the midst of the Lights as they choose to call, invite, and test us, to abide within us. Our Breath determines levels of body manifestations and their habitations. We bear witness of the Serpent of Dan in our bones and tissues ever moving by Spirit explorations in a genetic trail of becoming (e.g. coccyx bone as the ascendant adder/horned viper; tabernacle measurements, designs and vessels). As a Serpent hung on the Scales of Judgement, we are capable of overthrowing large forces, providing justice for all peoples (SMB/Gen 49:16-17), altering directions quickly, and changing skins through transformations unto the perfect glorified state of the Fathers in whom we belong worlds without cessations.*

*The Anointing Oil, as it rises condemns not the branches lest it has no path to the crown, rather upholds them and affirms their origins with true judgements—discernment of sides, whereby as the Anointing/Christ comes, there is no word of condemnation, but rather only agreement to affirm the coming, being sent to bear an Anointed Head with gemstones and diadems.*

Yarrdenn: Baqarteuwah, brethren! Shmuel the utterance of your words are most provocative! Blessed day All.

Cheresti: Does QaNah/Jealousy forcefield the Branches during their processes of extracting from the blueprint memory of the Seed without having to rely on the static memory obtained during the process...

*Got to wrap my head in yours. Forcefield the branches while tapping into the blueprint recorded... Now that is an awesome question that bypasses static memories that may be hindering development?*

Cheresti: Yes, the hinderance of extraction. Jealousy for another’s state or possession is self-injury; but jealousy for ALhhim may drive the Seed upwards as in fields of seclusion reserved for the process. Yes, this is what I seek. Fields of seclusion seem to be a trial. Detachment.

*Static memory would not be necessary as new codes are recorded in the process of ascension, that overwrites former paradigms and states of holding.*

Cheresti: Righteous.

*Fields of seclusion are those organelle territories dedicated by Words of ALhhim reserved to fuel the Seed ascensions.*

Cheresti: You have to KNOW that the Word Orientation is Greater than the premature static. The New codes formed from each Oylah gives confirmations to the concept that We are consistently in the Present and that the Past and Future are states within its center. I need these exchanges.

*The New codes formed are already present in SEEd, but now appearing through releases; Yes, We are consistently in the Presence of the FACES. The Past/foundations and Future/becomings are states within its centre.*

**Aspirations of DAN see in advance the glory of the Faces appearing in all SEEDNames and filling their ordained houses with judgements of ALhhim!** Whatever is developing in a House contrary to orchestrations of the Spirit forming a glorious tabernacle will encounter opposition, an adversary, as shatan/satan, by Dan (CHP/Number 22:22; I Corinthians 2:7,10,11) through which a Name and their members move with DAN into the Seven Wells of ALhhim—BaarShevoo, being showered with insights and open gates of wonder in the Kingdom (ALphaShmuwAL/1 Samuel 3:10,20). Developments of a NAME and their Numbers of Breath are approved by the ALhhim of Rayish Oyin whereby the movements and constructions of Temple occur causing the Head and Body to have Pulse with empowering thoughts that pertain to the mission and callings of our Stones to abide together in one BodyHouse.

In that DAN is born of the Shayin Semek ALhhim of the Fathers, the Spirit of our Name will reside in only pure and polished gloried Stones of Yaoquv, judging all within us to be ITS House of perfections, as Wisdom returns to the Side of Understanding, aligning our Faces to the Fathers of Olde, from whom we appear. **The House of AL is in DAN**, as scribed in Bayit/2 Malekim/Kings 10:29; for the House of AL is in the Spirit, not in flesh (Yahuchannan 4:23).

## KINGS OF DAN

Kings judge their members/bodies/camps with Wisdom and Understanding (ALphaMalekim/I Kings 3:9), to be of the order of Malekkiytsedeq (a Master of Alignments), able to speak and perform in Visible domains as they are aligned to what is in Invisible domains ●. What is in DayLight—appearing, becomes connected directly with NightLight—concealing, by which a Name is perfected, having been “baked on both sides.” (Hosea 7:8). The two sides of Name are the Eternal Supply of Light—Fire (left) and the Vapours of Manifestation—Water (right). As one of Avrehhem is sent, to walk before the Faces to become perfect, the Seed of Name becomes expanded thereby revealing all in Seed by Wisdom (SMB/Genesis 17:1). Perfection and blamelessness are achieved as what is shown by Water becomes hidden in the Fire of Understanding. When Wisdom of Waters commences to rise from the Fires of Dan, the evidence of inner patterns display outwardly. Upon conforming the outer Faces to the Inner Side of Becoming, one turns what is outward inwardly to the Fire, whereby the manifestation is now healed, completed, joined to its Source Faces.

The **Names of Kings** in the scriptures are personifications of masteries as SEED of ABreHHem expands. These Names of Masteries are in the two sides of your TempleBody: those headed by Yahúdah, allocating Numbers by Seed openings by the North Wind of DAN to determined states of residence, and those headed by Aparryim, providing blessings upon your Seed as your Seed rises in the South in the House of BaarShevoo—the Seven Eyes/Wells of RAúwaben. The moons of a year are marked by Numbers—sequential developments of Dan that generate a harvest of Seed. At the time of the spring and fall equinoxes, the Heads of these two camps set in motion your movements/progressions on both sides of the Arúwan/Ark that shines from the two sides of Spirit (CHP/Numbers 2:17). Yahúdah sets the Numbers of SEED in motion for their cultivation and harvesting unto Aparryim. The greenings of Yahúdah in the spring come as the golden brownings of Seed in Aparryim open from days of harvest. The works of Kings amongst these shifts of Light temper your days of sowing and harvesting. The kingdom of Yahúdah, by imparting WordNumbers in your Seed for sequential habitations, affect awakenings unto the South growing season in a study, whereas the kingdom of Aparryim blesses and distributes Grain at the gathering of your Seed unto your northern paths of harvest. Studies of Names of KINGS provide stimuli for your masteries to appear and rule within your branches in domains of ALhhim.

The studies of Spirit concur amongst rotations of Days of its offerings/oylut. Summations of days are called years. What is SeedSpun within your studies of Dan and BaarShevoo come forth as WordMasteries of Breath, commonly referred as Kings of the North and South of YishARAL. The record of these Names rising within you are according to your studies/years associated with prophecies unfolded by the Names of Prophets and their Scribes, whereby Kings are anointed to rule amongst your members in the two sides of your houses through prophecies (BayitMalekim/2 Kings 22:3). From the Days of ShmúwAL, the promises that you will be a kingdom is renewed with prophecies by which your Kings are anointed (ALphahShmuwAL I Sam 11:14; 2:10, SMS/Acts 3:24). The years that a King lives/ascends within you are records of the Words of Prophets as they inscribed in your “skins” as scrolls. Those called, “Good Kings,”

pertain to gathering and regulating forces of the ALhhim within your members; and those called, “Evil Kings,” pertain to shepherding your flocks of ALhhim inwardly. These Names of Masteries assemble the Goodness in your sides as a nation and Shepherd your members in their paths of progressions. The Kings of YishARAL, anointed by ShmúwAL in your studies/years, achieve outcomes of their rulings which are recorded in the Tanak. *e.g.* The extent of the Mastery of Yirbooam/Jeroboam, increases consciousness, evolving from a generation/prodigy of Nabat—who looks and keeps a fixed gaze in Unity, affirming the Chatat/Alignment offerings (leaving behind offenses) of the sum of YishARAL, whereby Father—Avi-Yahua, of the Breath, does not turn aside from the Golden Circles, ***verifying the House of AL (Bethel) to be in DAN. As the Spirit, Dan pervades the Seven Hills rising up as Mountains in the Seven Wells of BaarShevoo. These elevations of Breath comprise what concur within offerings at the place of your Yerushelyim Heart Altar. Together, Dan and BaarShevoo are the House of AL.***

***“Give therefore to your servant an understanding heart, TO JUDGE—discernment of the composite Faces in your people, and discern between—in the midst of the good—the Collective WordState, and evil—for Shepherding your flocks as the Unseen Hand. For who shall be able TO JUDGE this people, your people which are so numerous—heavy laden with glorious deposits?” YeDiDyæhh (Name of Solomon called by YHWH)***

The Leaves of DAN commenced as a study of 70 Names of transference from illusive boundaries of Metsryim/Egypt into realities of the TEN WORD STATES of BEING (ChameshHhaPekudim/Bemidbar/Numbers 26). In wonderments, the document of one Name, Shucham, of the Seventy, unfolds the works of Breaths and imparts secret dynamics in the House of DAN unto masteries of Kings. Contents of this work include the designation of ALhhim by pairs that form our 12 Houses of organellestones and their States of Lauíwi/Unified Habitations in which pairs of the Faces of Yehu dwell. In that our Fathers have built themselves chambers for their Lights and Words of ALhhim to abide, as the House of Dan, they never leave us nor forsake us.

Dan oversees details in allocating Numbers that rise from Yúwsphah in Seed for building your Houses as sanctified vessels and then fills them with all good Words of stones and jewels (SYM/Exodus 35:30-35). You are dwellings/habitations of the Fathers’ Work—The Bet HaShem. As Children, being impartial with one another, you are also about your Fathers’ Business/Enterprise.

[www.bethashem.org](http://www.bethashem.org)

Days of Nephethi, the Knowledge of Dan unto Yahúdah, The Berúwkah Moon 2020

Printed in Days of Dan’s Waters of Ayshshur